



Two-stage demand-side management in energy flexible residential buildings

Downloaded from: <https://research.chalmers.se>, 2026-04-04 12:46 UTC

Citation for the original published paper (version of record):

Fotouhi, A., Antoniadou-Plytaria, K., Steen, D. et al (2024). Two-stage demand-side management in energy flexible residential buildings. *JOURNAL OF ENGINEERING-JOE*, 2024(4).
<http://dx.doi.org/10.1049/tje2.12372>

N.B. When citing this work, cite the original published paper.

Two-stage demand-side management in energy flexible residential buildings

Mohammad Ali Fotouhi Ghazvini  | Kyriaki Antoniadou-Plytaria | David Steen |
Le Anh Tuan

Department of Electrical Engineering, Chalmers
University of Technology, Gothenburg, Sweden

Correspondence

Mohammad Ali Fotouhi Ghazvini, Chalmers
University of Technology, Gothenburg 412 96,
Sweden.
Email: ma.fotouhi@gmail.com

Funding information

Energimyndigheten, Grant/Award Number:
I-GReta(646039 and 775970); Göteborg Energi,
Grant/Award Number:
SN11 “Innovative energy management sys-
tem for smart buildings and grid interactions”;
Horizon 2020 Framework Programme,
Grant/Award Number: FLEXIGRID (864048)

Abstract

In this study, an optimisation model is developed for two-stage energy management of a residential building to minimise energy cost under monthly power-based tariffs for peak demand and time-variable electricity prices. The expected peak demand is determined in the first stage, and then the energy management system minimizes energy costs during the second stage. The second stage’s optimisation problem is solved in a rolling time window, facilitating real-time operation of flexible energy sources in the building. This includes optimal charging and discharging of the battery energy system, electric vehicle battery charging, heating system operation, and determining the optimal start times for washing machines and dishwashers, all close to real-time. The proposed approach enables users to predict and manage peak demand in daily operation, staying below the predetermined value through a close to real-time energy management system. The effectiveness of this two-stage approach in demand-side management for residential buildings is demonstrated through a realistic case study.

1 | INTRODUCTION

The energy systems are undergoing rapid changes in technology and operation, such as the growing electrification of the heating and the transport sectors and the shift from a highly centralised to a more decentralised energy system with high penetration of renewable energy sources (RES). These changes are the key measures for decarbonizing the energy systems, and thus considered as the most contributing factors in the transition towards sustainable energy systems [1].

1.1 | Motivation

Electrification of the heating and transportation can lead to increased peak in electric power demand, which is undesired for the power grid [2]. This is expected to cause congestion in the grid in short-term and create the need for grid reinforcement in long-term [2]. Grid operators typically have to make substantial

investments into new infrastructure to support the peak growth [3].

Dimensioning of the distribution network is based on the peak demand, though the consumers are mainly charged for the delivered energy [4]. Therefore, there is a growing trend to charge the consumers partly depending on the peak demand using power-based tariffs for a cost reflective distribution pricing [4].

Besides the benefits of RES in energy decarbonization, large-scale penetration of these sources can cause crucial operational issues for power systems, such as supply-demand imbalances [5–7].

Using the flexibility at the demand-side is a sustainable and practical solution for the challenges caused by the increasing electrification and penetration of RES. Flexibility provision from multi-energy systems, where different energy vectors such as gas, electricity and heat are integrated, becomes more effective despite the planning challenges caused by the uncertainty in the underlying energy vectors [8].

This is an open access article under the terms of the [Creative Commons Attribution-NoDerivs License](https://creativecommons.org/licenses/by-nd/4.0/), which permits use and distribution in any medium, provided the original work is properly cited and no modifications or adaptations are made.

© 2024 The Authors. *The Journal of Engineering* published by John Wiley & Sons Ltd on behalf of The Institution of Engineering and Technology.

1.2 | Research objectives

This paper aims to shed light on the economic value and the potential role of energy management systems (EMS) in reducing the peak and the energy cost at residential buildings. The building EMS is an intelligent automation system that provides decision support for the consumers in order to manage the energy and peak power consumption. To achieve this, the EMS sends control commands to the energy sources over the home-area network (HAN) [9, 10]. Without an EMS it would be particularly difficult to manage the peak demand, because the overall peak depends on the coincidence of the consumption of many devices in a building [11].

This model is developed for a smart building with a photovoltaic (PV) installation coupled with a battery energy storage (BES). The main energy intensive appliances in the building are the electric vehicles (EVs) and the heat pumps (HPs). The controllable household appliances are washing machines (WM) and dishwashers (DW). The heating demand in the building is served by the district heating (DH) network and HPs. The proposed building EMS model enables automated response to price signals or critical events from the utility company.

1.3 | Literature review

The energy management problem has been extensively studied in the literature, mainly as a day-ahead scheduling problem. The day-ahead consumption scheduling for controllable energy sources such as an electric water heater and an EV at a smart household is performed using an optimisation-based EMS in [12]. The results showed significant benefits for the end-users, who were able to reduce energy cost by around 30%, thanks to the proposed intelligent algorithm that controlled the devices and determined the sales to the grid. A home EMS is modelled in [10], which allows the end-users to participate in demand response (DR) programs. The EMS schedules the operation of the household appliances and BES as well as the EV charging, considering the uncertainty in supply, demand, and electricity prices.

Apart from the day-ahead scheduling, there is also research that focuses on model predictive control (MPC) [13], also known as receding or rolling horizon (RH) control, which utilise feedback in an iterative process that adjusts and improves the control output multiple times within the (typically daily) time horizon. Ref. [13] proposes a MPC controller with a discrete two level control signal for operating the heating, ventilation, and air-conditioning (HVAC) system of a building equipped with PVs.

Reducing the peak consumption is also considered in the energy management models through peak power tariffs or penalties. Such a penalty, in addition to a real-time energy pricing scheme, was considered in scheduling implemented by the home EMS developed in [9]. The proposed EMS controls the energy resources in a residential building, including the lifestyle-related operational dependencies of the appliances as a set of constraints in its integrated optimisation model. As a result, the

load is shifted from peak pricing periods to off-peak pricing time slots. Wang et al. proposed a multi-objective optimisation model for a multiple home EMS in [14]. The three objective functions are the energy cost minimisation, minimisation of peak-to-average ratio (PAR) of the load profile, and maximisation of the consumer satisfaction. Thus, the objectives of the consumer and the grid are both incorporated in this model. Qayyum et al. [15] formulated the operation of a home EMS with two objective functions with the aim to minimise both the maximum peak load and the total cost. Mainly, when studies seek to reduce peak power costs, the peak demand is minimised in the short-term, with the assumption that the consumer will be charged with respect to the daily peak demand. However, this approach is sub-optimal, as in reality, households are billed for their monthly peak consumption.

Due to the coupling of their multi-energy resources, the residential buildings have recently being modelled as multi-energy systems and, in this case, they are often referred as “energy hubs” in the literature. In these systems, the management of the resources is studied in an environment where different networks and carriers can interact with each other. Su et al. [16] addressed the problem of dynamic switching between natural gas and electricity for households with gas-electric heater and stove. Other controllable sources in this paper are the air conditioning system and the washing machine. The objective functions are the minimisation of the total operating cost and the minimisation of the emissions of the harmful gases. The users’ tolerance degree of hot water temperature and room temperature are considered as system constraints.

Day-ahead consumption scheduling of controllable household appliances such as electrical energy and thermal storage, electric HP, boiler, and absorption chiller is formulated in [17] by an energy hub model, considering electricity and natural gas as inputs. The objective is to fulfill the daily cooling, heating and electric demand of the building while maximising the profit, considering the possibility of exchanging electrical energy with the grid. The integration of the electricity and heat distribution networks is modelled from the perspective of deregulated markets in [18] to evaluate the strategic behaviours of a profit-driven energy hub in the electricity and heat market. Such models can be used by the energy hub owners to determine the optimal bidding strategies in the market and by the investors to examine the profit of an energy hub under a given system design. A probabilistic EMS for a renewable-based energy hub is developed in [19] for a system with different energy converters and storage units. The uncertainty associated with the output power of the PV panels is modelled with the two-point estimate method to reduce the computation burden. The optimal investment and operation of a nearly zero energy building is studied in [20]. Both the cost optimal sizing of the energy technology and the technology type are considered, while making investment decisions from the perspective of the building owner’s perspective.

The majority of the studies on building energy management use low time resolution of load and generation profiles, which also yields a low-time resolution control. The time resolution, also known as time granularity, is typically 1 h, which is not

sufficient to capture the peak power patterns, as studies on the impact of time resolution have shown [21]. Although the iterative process of the RH approach brings the energy scheduling closer to real-time control, the low time resolution of most recent studies [13] that employ RH control, which typically use hourly time discretization steps, makes them incompatible with close to real-time control. Moreover, these studies do not consider the effect of peak power, which is particularly challenging to assess with moving time horizon.

Wang et al. (2022) [22] introduced a novel coupled air and ground source HP system with energy storage, applied to a hotel building. Their study focused on optimizing the system's operation modes to maximize the COP and ensure soil heat balance. They demonstrated significant improvements in heating capacity and reductions in operational costs, highlighting the system's economic and environmental benefits in cold regions.

Seal et al. (2023) [23] presented a centralized model predictive control (MPC) for home energy management, utilizing EVs as mobile energy storage units. Their approach addresses the uncertainty in EV availability and optimizes energy transactions with the grid based on time-of-use rates, demonstrating notable reductions in energy costs while maintaining thermal comfort.

Zou et al. (2023) [24] conducted a comprehensive review on the integration of plug-in EVs in energy-flexible buildings. They analyzed the impacts of surging EV charging demand and explored collaborative management technologies between EVs and building energy systems, emphasizing the importance of co-management strategies for enhancing building energy performance and accommodating increased EV penetration.

1.4 | Key features and contributions

This paper presents an energy scheduling model proposed for a practical building EMS for residential customers. The proposed model offers significant advances over most other EMS models in the literature, as: (1) it combines the RH approach with high time granularity thus enabling close to real-time control; (2) it considers both the heating and the electricity system of the building and can therefore be applied for multi-energy scheduling; (3) applies energy scheduling with a non-uniform time horizon to account for realistic assessment of peak demand costs. To the best of the authors' knowledge, none of the previous studies have developed a building EMS that provides all the above-mentioned advantages.

In contrast to most EMS models proposed in the literature, the focus of this paper is on close to real-time control of the sources rather than the day-ahead load scheduling. Contrary to scheduling problems, the real-time operation control requires solving optimisation problems iteratively, and determining the decision variables for the control intervals. The specific contributions of this paper are:

- (i) A two-stage optimisation model to minimise the energy cost of the residential buildings, considering the peak demand charges on the monthly bills is proposed. The model is used to formulate a month-ahead optimisation

problem solved at the first stage and a day-ahead optimisation problem solved at the second stage for real-time energy scheduling.

- (ii) A mixed-integer linear programming (MILP) framework is developed that incorporates both heating and electricity system into the formulated optimisation problems. Thus, the model can be used for multi-energy buildings to capture the interaction between the electricity and the DH networks and unlock energy flexibility potential that can significantly reduce the buildings' cost.
- (iii) A building EMS is developed that employs the integrated two-stage model to solve the formulated problems utilising a RH approach with high time resolution. This approach enables close to real-time energy dispatch of the controllable resources and loads.
- (iv) A pragmatic case study based on a residential multi-family building, which demonstrates and quantifies the savings and peak reduction potential of implementing an optimisation-based close-to-real-time EMS.

1.5 | Paper organisation

This paper is structured as follows: Section 2 gives an overview of energy management in smart buildings. The methodology is explained in Section 3. Section 4 introduces the test system and the input data of the EMS. The results are presented and discussed in Section 5. The paper ends with Section 6, which presents the main findings whilst indicating the future extensions of this work.

2 | ENERGY MANAGEMENT IN BUILDINGS

The building sector is a large energy consumer, and accounts for the highest share of energy consumption among major economic sectors. Specifically, it accounts for 33% of the global and 40% of the European Union total energy consumption [13]. This leads to high energy costs for the end-users, which are related to the amount of energy consumed, the price, and the time of the peak power consumption. Even without reducing the total amount of energy consumption or upgrading to equipment and devices of higher energy efficiency, these costs can significantly be reduced by changing the energy schedule and altering the energy profile, that is, the amount and time of energy consumption. In order to implement changes in the energy profile without requiring too much effort from the end-users, it is essential to use an advanced control system that will deploy the demand-side energy flexibility schedule the buildings' energy sources by properly scheduling the buildings' energy sources [25]. Buildings with automatic control systems that offer the potential to modify their energy profile are called energy flexible buildings.

The building operators and the residents of energy flexible buildings can actively participate in DR, which is enabled by the deployed automation system and advanced metering sys-

tems in the buildings, as well as by two-way communication interfaces for interactions among the energy sources, the building EMS, and the utility [9]. The level of engagement in DR is also influenced by the physical characteristics of the building, its loads and energy sources, and the willingness of the end-users [25]. Since the marginal cost of integrating RESs into the building energy systems is decreasing, more and more end-users are choosing to install RES in their residencies. Thus, from passive consumers they become active prosumers, which increases their potential to benefit from DR programs because they can reduce their energy cost by properly utilising their self-generation energy sources [9]. At the same time, these programs can benefit the energy company [9], while they can also be designed to support the operation of the grid by maintaining the balance between supply and demand and limit the peak demand in grids with high penetration of RES [9].

The residential loads can be divided into controllable and non-controllable loads from the energy management point of view. The non-controllable loads refer to must-run appliances over which the building EMS has no control [26]. The operation of non-controllable loads solely depends on the users' will [27], as it is strictly dominated by their comfort and their convenience. In addition, this operation is mostly non-responsive to price signals [25, 28]. In contrast to non-controllable loads, the operation of controllable loads can be scheduled and controlled in the allowable operation intervals [19, 28]. The integration of the controllable loads into the building EMS leverages the decision-making of the consumers and their participation in DR programs [10].

Energy pricing plays an important role in consumption management. It can considerably influence the consumption pattern. They can be designed to support the system to achieve reliability objectives [29]. Energy can be charged with fixed rates or dynamic tariffs. Many energy providers around the world have started to offer real-time pricing rates for energy, specifically for the electricity. In the dynamic tariff price scheme, the provider's marginal costs are directly passed to the consumer [11].

Energy billing is essential for the cost recovery of the supplied service [29]. The final energy bill should cover all expenses of the energy provider to deliver the service to the consumer [29]. A typical energy bill is composed of different components. It is composed of energy charge, capacity charge and an access charge [9]. Some providers also charge the consumers for the peak demand during the billing cycle.

The demand charge tariff is a peak-load-dependent tariff [9]. It can appear in energy bills in different forms. A possible consequence of not charging consumers for the peak load is the reduction in the business income of the utility companies. This happens when the increase in the peak demand is accompanied by the reduction in the total energy consumption [4].

Koski et al. [4] studied the case of Finland, in which the distribution system operators (DSOs) can freely select the tariff structure. The energy regulator monitors the market and ensures that the DSOs' total revenue is regulated to avoid misusing the state-controlled monopoly and to ensure equality among end-users. The impact of using power-based tariffs on

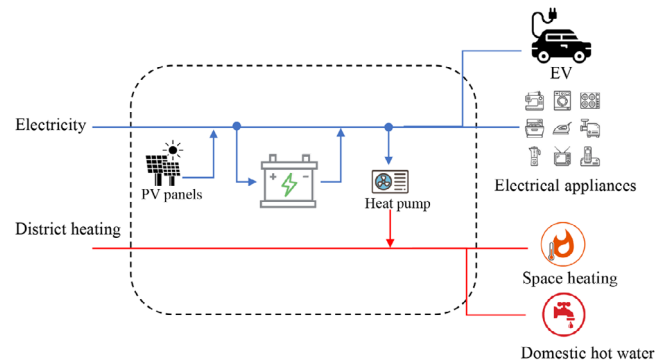

FIGURE 1 Energy hub representation of the building energy system.

the customers' power usage was investigated in that study. The power-based tariffs were compared with the energy-based tariffs for the customers. The results revealed that the actions of the consumers are not sufficient to compensate the peak power increases in longer time. Based on the survey results, an automated system that does not affect the living comfort of the users, even if controlled by a third party was a more acceptable option for the customers.

Multi-carrier energy environments promote the evolution of sustainable energy systems by facilitating the interaction among electricity, heat, cooling, fuels, and transport at different levels [30].

The concept of energy hub has been developed to study multi-carrier energy environments [19]. It is defined as a virtual box with different forms of energy carriers as inputs and a set of energy demands as outputs, including several technologies to convert and store different forms of energy [31]. It is the place where conversion, storage, production and consumption of various energy carriers take place [19]. An energy hub is characterized by a set of formulations to model the dynamic operation of electric and heat devices and relate the inputs and outputs of the model [32]. Figure 1 illustrates the components of the energy hub model used in this paper.

3 | METHODOLOGY

The energy management problem of residential buildings is formulated as a two-stage problem, with the ultimate objective of reducing the total energy cost. The problem is solved month-ahead in the first stage, and the optimal values of the monthly peak demand are used as inputs for the second stage.

In stage two, a close to real-time EMS is developed for a multi-family residential building. This model is proposed for an energy flexible smart building, and the control commands for the loads are determined in a rolling time window to optimise the operation of the loads in real-time. The building is equipped with PV system and BES, which is used to maximise the self consumption of the solar power. The heating system, EV charging and the operation of WMs and DWs are controlled in this model.

PAR is used to evaluate the performance of the demand response programs. PAR is calculated for the consumption profile modified by the proposed EMS as well as for the consumption profile that is not modified. Comparison of power PAR before and after implementing the month-ahead scheduling reflects how energy flexibility could reduce the peak power.

3.1 | Stage one: Month-ahead scheduling

In this stage, the optimal peak demand for the coming month is determined with a linear programming model. The peak demand is calculated and recorded as the moving average of the power consumption over a specific period [9]. It is the maximum value of the measurements of average power consumption over a specific time interval (e.g. 15 min, 30 min or 1 h). It is assumed that the utility company charges consumers with calendar month billing cycle, and the consumers are charged for the monthly peak load with power-based tariffs. Therefore, it is essential to obtain this value and avoid violating it during the whole month. The calculated peak is used in the second stage as a parameter in the model, and the building EMS will ensure that the average consumption power does not exceed this threshold.

The objective function in this stage (1) is to minimise the monthly electricity cost (MEC). In this model, the consumers are charged for the peak electric demand, not for the peak consumption from the district heating network. MEC is composed of the peak-load-dependent costs and energy costs for electricity. Constraint (2) ensures that p_{Max} is equal to the peak consumption during the scheduling horizon (T). The duration of time intervals is τ hours.

$$\text{Minimize MEC} = \sum_{t \in T} [p(t) \cdot \lambda(t) \cdot \tau + p_{Max} \cdot \lambda_{peak}], \quad (1)$$

$$p(t) \leq p_{Max}, \quad \forall t \in \mathcal{T}. \quad (2)$$

Several techniques are proposed in the literature to characterise the energy flexibility potential of buildings. The two techniques generally used to estimate the flexibility potential employ the building simulation tools and models based on the experimental data [25]. For instance, Junker et al. [25] proposed a model to characterise the energy flexibility of buildings with a dynamic function that can describe to what extent a building can respond to grid requests for the flexibility. A flexibility index is used in this model.

The flexibility of the load is specified by the direction (upward or downward), size (kWh and kW) and time [29]. Characterisation and quantification of power-related flexibility in the building is beyond the scope of this paper, and thus it is assumed that the flexibility of the demand is already estimated and it is considered as input to the model. The variations of the load are bounded by an upper and a lower limit in this model. P_{Dn} and P_{Up} in constraint (3) are, respectively, the lower and upper limits that represent the range for variations of the load around the forecasted demand (P_{FT}). Constraint (4) ensures that the energy consumption during a set of time periods remains the same and

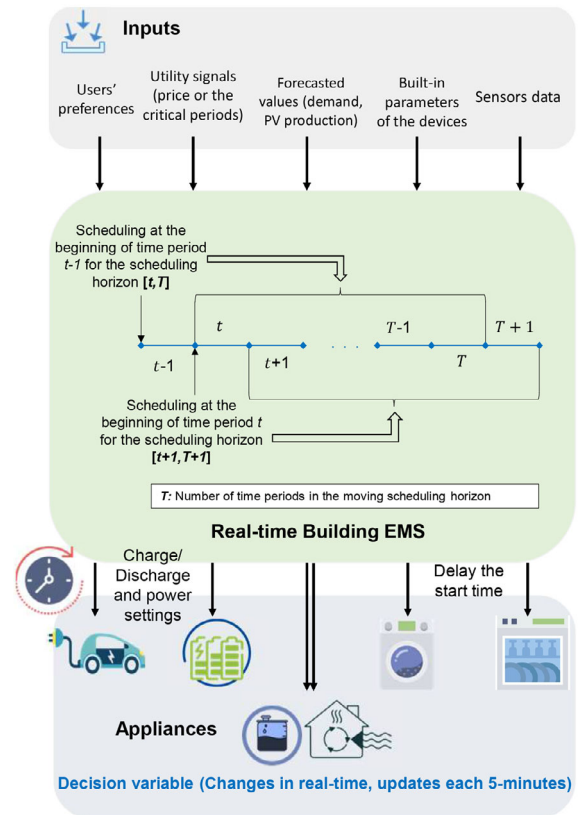

FIGURE 2 Schematic of the proposed building EMS in stage 2.

the load is only shifted to other periods. \mathcal{T}_b which is subset of \mathcal{T} denotes the set of time periods that belong to block b , in which the energy consumption should remain same.

$$P_{Dn}(t) \leq p(t) \leq P_{Up}(t), \quad \forall t \in \mathcal{T}, \quad (3)$$

$$\sum_{t \in \mathcal{T}_b} p(t) = \sum_{t \in \mathcal{T}_b} P_{FT}(t), \quad \forall b \in \mathcal{B}. \quad (4)$$

3.2 | Stage two: Real-time energy management

A real-time rolling horizon energy management model is proposed in stage two to control the consumption of controllable energy sources in the building. The input information is periodically updated for the online optimal energy/power control of the energy sources [33]. The control variables are determined by repeatedly solving a MILP problem over a moving window [34]. The rolling horizon approach mimics the environment in which the users can change their requirements on a daily basis. The EMS is designed to operate continuously in the building, and ensures that the optimal peak demand calculated in the first stage is not violated.

Figure 2 shows the main inputs and outputs of the proposed building EMS. The control commands are the the decision variables of the optimization problems solved in each iteration.

They are determined for the next time interval in each iteration, and can be sent to the loads and appliances in the building. Although the decision variables are determined for the next 24 h in each iteration of the problem, only the decisions for the next time interval are considered as the control commands.

The control commands can activate, de-activate or delay the function of the controllable building appliances and energy sources, switch between different sources and specify operation set-points. The control commands transmitted to the EV charger determine the charging current. Control signals can set the BES to charging, discharging, or rest mode (open-circuit), while the BES power set-points during charging and discharging mode are also transmitted. Another control signal triggers the switch between HP and DH to serve the heat demand. The EMS also decides the optimal time to start uninterruptible loads like WM and DW. Therefore, it can send control commands that delay the operation of these loads.

The EMS operates based on the inputs from the users. As the acceptance of a building EMS depends on the satisfaction of the users, it is essential to consider the preferences of the users as inputs to the model. For instance, the users determine when to have the dishes or the clothes washed and what washing program to choose. For the case of EV charging, the departure time of the EV and the expected state of charge are the main inputs given by the users when the vehicle is plugged in.

The objective function is minimising the energy cost in a rolling time window, considering the energy prices and the operational limits of the loads. In this model, the users should be allowed to alter their preferences in real-time over the operation. The cost function for each iteration i is presented in (5). Besides the energy cost for electricity (denoted by λ), the objective function of stage two also includes the cost of heating energy delivered to the building from the DH network (this cost is denoted by ζ). The power-based network tariff is not included in this cost function, because the user is charged for the peak power in the monthly basis and it is important not to violate the peak power determined in stage one. Equation (6) ensures that the load always remains below the peak power determined in stage one. In stage two, the length of time interval τ depends on the frequency of the update of the control commands. In stage one, the choice of τ depends on how the power-based network tariff is applied. For example, if the users are charged for the peak demand considering the hourly average power measurements, then τ in the first stage is 1 h.

$$\text{Minimize} \quad \sum_{t=i}^{i-1+T} [p_i(t) \cdot \lambda_i(t) \cdot \tau + g_i(t) \cdot \zeta_i(t) \cdot \tau], \quad (5)$$

$$\forall i \in \mathcal{I}$$

$$p_i(t) \leq p_{Max}^*, \quad \forall t \in \mathcal{T}, \forall i \in \mathcal{I}. \quad (6)$$

The electric power and heat flow balance equations are, respectively, presented by (7) and (8). The electrical load, which consists of the non-flexible load $P_i^{NF}(t)$, the electrical consumption $p_i^d(t)$, $p_i^v(t)$, and $p_i^{HP}(t)$ corresponding to smart appliances, EVs, and HPs, respectively, as well as the charging

BES power $p_i^{Cb}(t)$ can be supplied at each iteration i by the power injected from the grid, the PV panel, and the BES, which are denoted as $p_i(t)$, $P_i^{PV}(t)$, and $p_i^{Dcb}(t)$, respectively.

$$p_i(t) = P_i^{NF}(t) - P_i^{PV}(t) + \sum_{\forall a} p_i^a(t) + \sum_{\forall v} p_i^v(t) + p_i^{HP}(t) + p_i^{Cb}(t) - p_i^{Dcb}(t), \quad \forall t \in \mathcal{T}, \forall i \in \mathcal{I}. \quad (7)$$

The heating system is also composed of DH network and heat pumps. The control commands for the inverter-based air-source HP and DH network determine how the heating demand can be served optimally from the two resources. The heat demand (D^{beat}) is composed of the domestic hot water demand (D^{HW}) and space heating demand (D^{SH}), which is supplied by the DH network and the heat pump (8). The DH is modeled with a constant efficiency (η^{DH}) in (9).

$$q_i^{DH}(t) + q_i^{HP}(t) = D_i^{beat}(t), \quad \forall t \in \mathcal{T}, \forall i \in \mathcal{I}, \quad (8)$$

$$q_i^{DH}(t) = g_i(t) \cdot \eta^{DH}, \quad \forall t \in \mathcal{T}, \forall i \in \mathcal{I}. \quad (9)$$

The variable efficiency model of HPs proposed in [20] is used for the air-source HPs. COP is the conversion efficiency of electricity into heat [20]. Equation (10) shows that the COP depends on the heat source temperature (θ^{source}), which is the outdoor air temperature for air-source heat pumps, and the supply temperature (θ^{supply}). The supply temperature (θ^{supply}) for the domestic hot water can be considered constant, but for the space heating it depends on the outdoor temperature, characterised by the heating curve of the HP. Thus, the value of COP varies for the space heating and the domestic hot water consumption. The coefficients k_0 , k_1 , and k_2 are obtained by fitting the manufacturers' data with a polynomial function. The average COP when delivered to a storage tank is the weighted average of the COP for the domestic hot water and space heating (11). The relation between the heat generated from the HP and the electricity consumed is expressed in (12). In this model, equation (12) utilizes the definition of $COP_i^{HP}(t)$ from Equation (11), which calculates the COP as a weighted average reflecting both domestic hot water and space heating demands. This approach is chosen over the fundamental temperature-based COP formula in Equation (10) to provide a more realistic representation of the heat pump's efficiency in varying operational scenarios within the building.

$$COP_i^{HP}(t) = k_0 + k_1 \cdot (\theta_i^{supply}(t) - \theta_i^{source}(t)) + k_2 \cdot (\theta_i^{supply}(t) - \theta_i^{source}(t))^2, \quad \forall t \in \mathcal{T}, \forall i \in \mathcal{I}, \quad (10)$$

$$COP_i^{HP}(t) = \frac{1}{D_i^{beat}(t)} \cdot (D_i^{SH}(t) \cdot COP_i^{SH}(t) + D_i^{HW}(t) \cdot COP_i^{HW}(t)), \quad \forall t \in \mathcal{T}, \forall i \in \mathcal{I}, \quad (11)$$

$$q_i^{HP}(t) = p_i^{HP}(t) \cdot COP_i^{HP}(t), \quad \forall t \in \mathcal{T}, \forall i \in \mathcal{I}. \quad (12)$$

Charging of the EV battery is considered as a controllable demand in this model. The charging does not necessarily begin

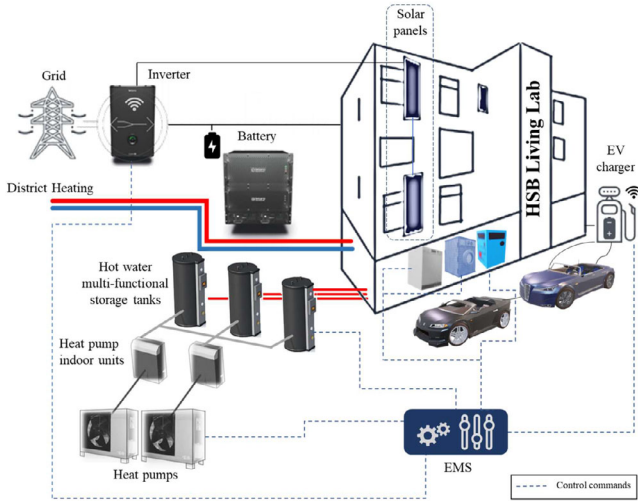

FIGURE 3 An overview of the controllable loads at the HSB LL.

when the EV arrives. Although in the rolling horizon optimization the time span during each iteration covers the whole set of periods, the decision variables of the upcoming time period are only sent to the devices as control commands. The variations of the SoC in each iteration and each time period for EV v is shown in (13). The user determines the departure time and the expected energy level at the departure time. The SoC variable is limited by the battery capacity. EV v is plugged in during T^v , and its' charging efficiency is shown by $\eta^{v,cb}$.

$$\begin{aligned} SoC_i^v(t) &= SoC_i^v(t-1) + p_i^v(t) \cdot \eta^{v,cb} \cdot \tau, \\ \forall i \in I, \forall v \in \mathcal{V}, \forall t \in \mathcal{T}^v. \end{aligned} \quad (13)$$

The SoC of the BES at the end of period t ($SoC_i(t)$) depends on the initial energy level of the battery ($SoC_i(0)$) and the charging/discharging power ($p_i^{Cb}(t)/p_i^{Dcb}(t)$). Equations (14) and (15), respectively, describe this relation for the first period in each iteration and the remaining periods, considering the charging and discharging efficiency of the battery (η^{Cb} , η^{Dcb}). The decision commands are applied to the BES only for the first time period in each iteration. Therefore, $SoC_i(0)$ in each iteration is equal to the SoC of the battery at the first time period of the previous iteration (16).

$$SoC_i(t) = SoC_i(0) + \tau \cdot \left(p_i^{Cb}(t) \cdot \eta^{Cb} - \frac{p_i^{Dcb}(t)}{\eta^{Dcb}} \right), \quad (14)$$

$$\forall i \in I, t = i,$$

$$SoC_i(t) = SoC_i(t-1) + \tau \cdot \left(p_i^{Cb}(t) \cdot \eta^{Cb} - \frac{p_i^{Dcb}(t)}{\eta^{Dcb}} \right), \quad (15)$$

$$\forall i \in I, \forall t > i,$$

$$SoC_{i'}(0) = \begin{cases} SoC(0) & i' = 1 \\ SoC_{(i=i'-1)}(t = i' - 1) & \forall i' \neq 0 \end{cases} \quad (16)$$

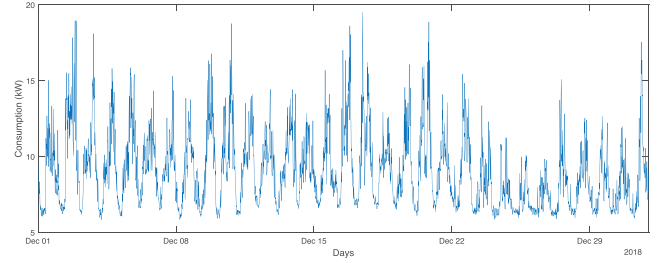

FIGURE 4 Forecasted demand of the building consumption during December 2018.

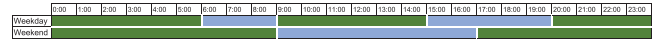

FIGURE 5 Time blocks for flexibility during weekend and weekdays.

Equations (17) and (18) limit the minimum and maximum power in the charging and discharging modes, respectively. Equation (19) is used to avoid solutions that yield simultaneous charging and discharging of the ES system.

$$\begin{aligned} P_{Min}^{Cb} \cdot x_i^{Cb}(t) &\leq \dot{p}_i^{Cb}(t) \leq P_{Max}^{Cb} \cdot x_i^{Cb}(t), \\ \forall i \in I, \forall t \in \mathcal{T}, \end{aligned} \quad (17)$$

$$\begin{aligned} P_{Min}^{Dcb} \cdot x_i^{Dcb}(t) &\leq \dot{p}_i^{Dcb}(t) \leq P_{Max}^{Dcb} \cdot x_i^{Dcb}(t), \\ \forall i \in I, \forall t \in \mathcal{T}, \end{aligned} \quad (18)$$

$$x_i^{Cb}(t) + x_i^{Dcb}(t) \leq 1, \quad \forall i \in I, \forall t \in \mathcal{T}. \quad (19)$$

In this model, the shiftable non-interruptible appliances are the WMs and the DWs. The operation of WM and DW is modeled with uninterruptible sequence phases [15]. The consumption profile of one complete operation cycle of appliance a is considered as input to the model. The EMS starts determining the optimal start time of the WM or the DW as soon as the user puts the clothes or the dishes inside the machine and presses the start button. At the beginning of each iteration, various scenarios for the consumption of appliance a can occur depending on the number of time periods allowed by the user. s_i^a is a dynamic set which changes in each iteration, and represents the scenarios that might occur. In each iteration only one scenario will be selected. Equations (20) and (21) impose these conditions on the model.

$$\dot{p}_i^a(t) = \sum_{s_i^a} x_i^{s_i^a}(t) \cdot P_i^{s_i^a}(t), \quad \forall i \in I, \forall t \in \mathcal{T}, \forall a \in \mathcal{A}, \quad (20)$$

$$\sum_{s_i^a} x_i^{s_i^a}(t) = 1, \quad \forall i \in I, \forall t \in \mathcal{T}, \forall a \in \mathcal{A}. \quad (21)$$

The time intervals for energy management in the two stages could differ: in the first stage, typically longer intervals are used to match the electricity company's peak pricing patterns, while in the second stage, shorter intervals are used for more precise real-time optimization. However, these intervals could be

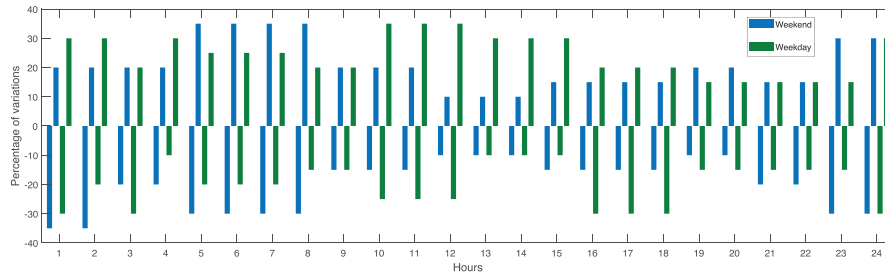

FIGURE 6 Flexibility of the power profile of the building.

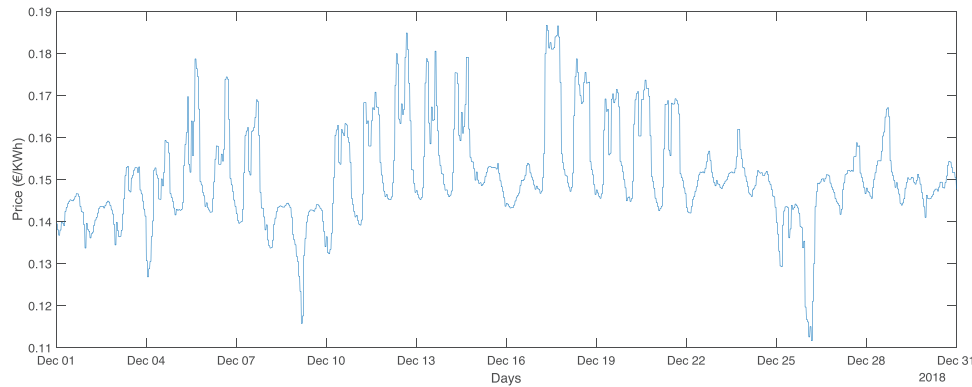

FIGURE 7 Time variable electricity price for one month ahead.

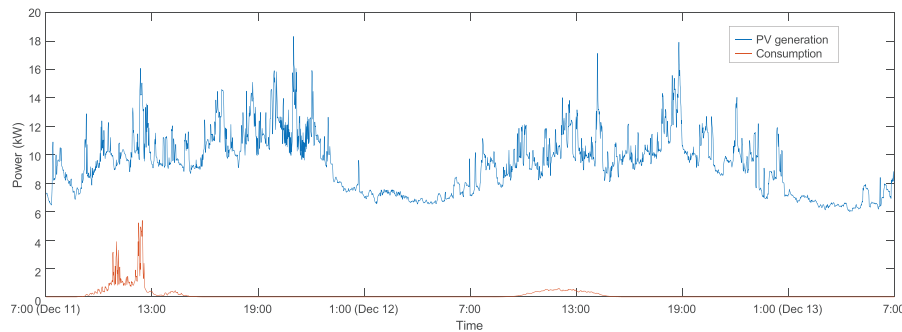

FIGURE 8 Power profile for PV production and consumption of nonflexible loads.

adjusted to be equal if such alignment better suits the energy management objectives.

4 | CASE STUDIES

The proposed two-stage energy management model is tested using the HSB Living Lab [35] data for December 2018 and the price data of Nordpool [36]. HSB Living Lab is a multi-family residential building of 29 apartments with the total usable floor area of 1,720 m² [35, 37]. This smart building is a unique testbed for sustainable living solutions, where the living lab approach focuses on applying innovation in human-centered systems. There is an 18 kW_p PV system in the building coupled with a 7.2 kWh battery. The battery can be charged from the

PVs and the AC grid. The PV and battery energy storage system is connected to the AC grid via a converter [38]. An overview of the controllable loads at the HSB Living Lab is shown in Figure 3.

In stage 1, the forecast of the total electricity load and the expected flexibility characteristics of the demand is used to calculate the optimal monthly peak.

The forecasted demand for electricity in 15 min time resolution for December 2018 is shown in Figure 4. Since the development of forecast algorithms was not in the scope of this paper, the historical consumption of the building used.

In the first stage of the model, the optimal peak value is calculated. For this problem, the flexibility potential of the demand is required. The flexibility characteristics of the demand is represented by two set of graphs.

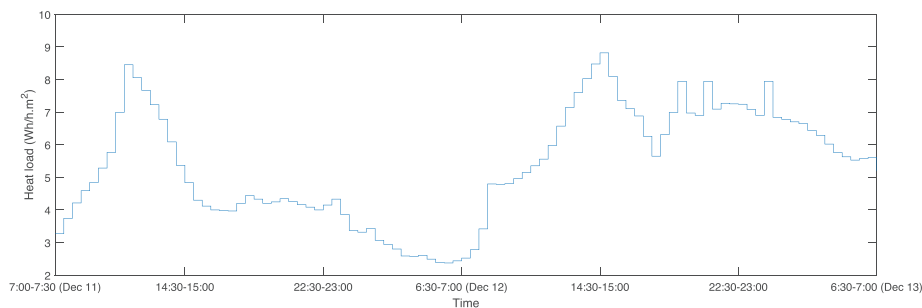

FIGURE 9 Heat demand profile.

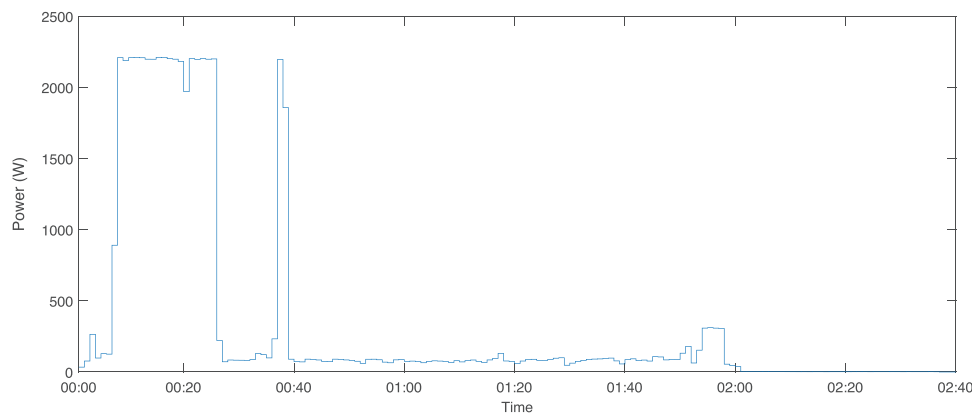

FIGURE 10 Consumption profile of washing machines [41].

Figure 5 shows the time blocks for load shifting for weekdays and weekends in December. The demand can shift in such a way that the total energy consumption remains constant in each of the blocks.

Figure 6 shows the upper and lower boundaries for load shifting during the weekdays and weekends in December.

The forecast of the electricity price is required for one month ahead. The price could be fixed or time variable, depending on the end-users' subscription. Figure 7 presents the electricity price for one month ahead. The end-users' prices are assumed to be time variable in the case study. The retail price that the customer pays follows the Nordpool prices plus a marked up for VAT, taxes, base rate charge and the guarantee of origin [39, 40]. The power based network tariff for charging the customers' peak consumption is determined in a way that the cost of peak demand charges does not violate 30% of the energy cost. In this case study, it is assumed that the customers are charged 16 Euros/kWh.

Since the time intervals in stage 2 are 5 min, the resolution of both forecasted data are in 5 min intervals. The scheduling horizon in each iteration of the stage 2 problem is composed of 24 h with 5 min time intervals. The development and implementation of forecast algorithms is not the focus of the paper. Thus, historical data recorded by sensors and smart meters in the building are used instead of actual forecasted values.

The proposed model is implemented for real-time optimal control of an energy hub over 24 h, starting from 11 December

2018 at 7:00. The PV production and demand profile of the nonflexible electric loads are shown in Figure 8. The resolution of the data is 5 min. The heat demand in the building is shown in Figure 9.

The data for two consecutive days are presented for scheduling in stage 2. The reason is the rolling window of the real-time scheduling and the need for the data for the next 24 h when making the decisions for each time interval.

Figures 10 and 11, respectively, show the consumption profiles of washing machines and dishwashers.

The characteristics of the the ES battery, EVs, washing machines and dishwashers are, respectively, depicted in Tables 1–3. An ES system with 7.2 kWh exists in the building. Four EVs are plugged in for several hours during the day. The inhabitants use four washing machines and three dishwashers and allow the EMS to delay the start time of the machine.

5 | RESULTS AND DISCUSSION

The optimisation problem for stage 1 is initially solved for the whole month of December 2018. As a result of solving the problem for this stage, the optimal value of the peak is determined for the scheduling horizon, considering the flexibility potential in the building.

Figure 12 shows the scheduled consumption profile after considering the flexibility of the demand. The optimal peak

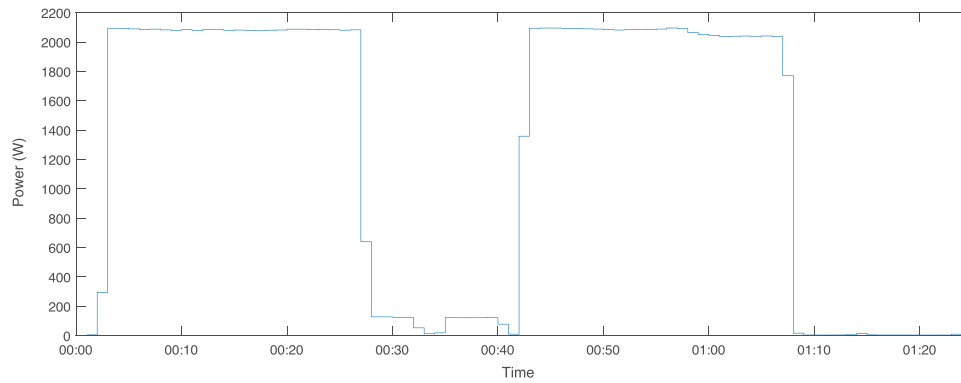

FIGURE 11 Consumption profile of dish washers [41].

TABLE 1 Characteristics of the ES unit.

Charging/discharging rate (kW/h)	Capacity (kWh)	Charging/discharging efficiency	Initial SoC (kWh)	Minimum energy
4.5	7.2	0.92	2	0.6

TABLE 2 EVs characteristics.

	EV 1	EV 2	EV 3	EV 4
EV models	Mitsubishi MiEV	Renault Zoe	Nissan Leaf	Hyundai Ioniq Electric
Arrival SoC level (%)	19%	27%	31%	18%
Expected SoC level at departure (%)	86%	82%	80%	62%
Charge rate (kW/h)	3.0	3.2	6.6	4.0
Charge/discharge efficiency	0.92	0.92	0.89	0.93
EV battery capacity (kWh)	16	22	24	30
Arrival time	07:42	10:33	22:16	18:58
Departure time	12:20	17:15	06:45	01:05

TABLE 3 Flexibility provided by the washing machine and dishwasher.

	Start time	Requested end time	Available time periods
WM 1	08:53	18:50	118
WM 2	17:36	22:35	58
WM 3	22:58	06:15	86
WM 4	20:02	00:05	47
DW 1	23:39	06:55	86
DW 2	07:13	12:45	65
DW 3	12:36	20:45	96

TABLE 4 Comparison of the consumption profiles.

Consumption profiles	Average	PAR	Variance
Scheduled demand	9.02 kW	1.85	5.77
Actual demand	9.02 kW	2.16	8.21

demand in the first iteration without considering the peak demand tariff is 19.5 kW, and after considering the power-based network tariff, it reduces to 16.7 kW. Considering the power-based tariff in the monthly electricity bill results to reduction of the peak demand for about 14%. As shown in the figure, the peak has reduced and it is expected that the same peak will be experienced several times during the month. This means that optimised control of the demand limits the peak to 16.7 kW.

Table 4 shows the comparison between the scheduled and the actual consumption profiles. As expected, the average value of the scheduled demand does not change in stage 1, since the demand is only shifted to other periods and there is no change in the total energy consumption. In both cases the average demand is 9.02 kW. Although the peak reduces in the scheduled demand, the variance increases compared to the actual case. The variance of the consumption power profile increases when the flexibility in the building is used. The value of the peak demand in stage 1 problem could change by varying the value of power-based network tariff.

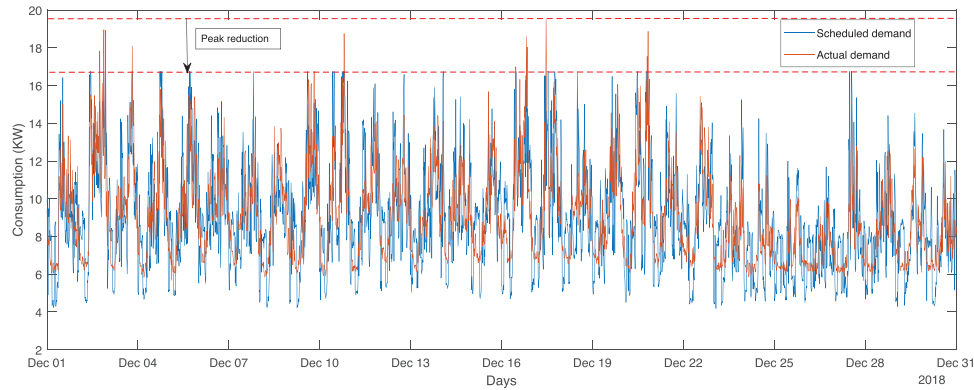

FIGURE 12 Scheduled demand using flexibility potential compared to actual demand.

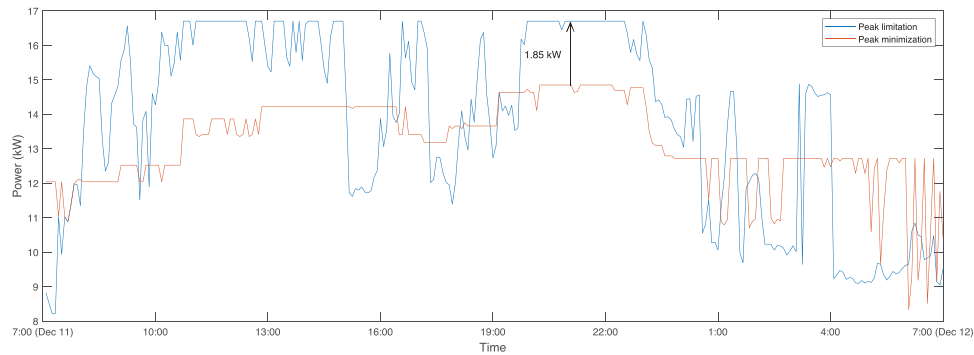

FIGURE 13 Power purchase from the grid.

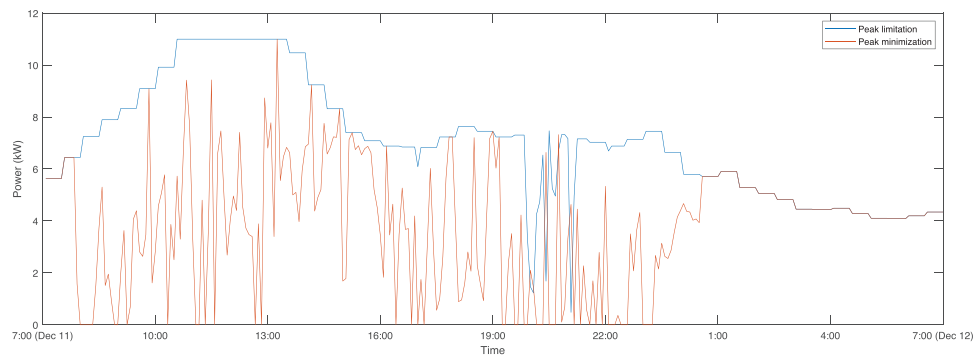

FIGURE 14 Consumption of the HPs.

The rolling horizon approach in stage 2 is solved for a typical day (i.e. December 8th) during the same month. The assumption here is that the peak is also not violated during the past days (i.e. December 1 to December 7). The peak demand value obtained in the first stage informs the customer that it is not economically beneficial to try to reduce the demand below this value, since it is highly probable to violate this value during the remaining days of the calendar month. The distribution company will anyway charge the customer for the peak value.

The rolling horizon model runs in real-time to determine the control variables. The control commands are determined for each time slot, while the problem is being solved iteratively during the day. The loads are controlled in such a way that the peak demand determined in the first stage is not violated.

The electricity consumption profile is presented in Figure 13. The consumption is controlled using the proposed strategy and it is compared with the case that the EMS considers the peak penalty in the objective function and thus leads to a minimised

peak load. The results show that the 1.85 kW reduction in the peak is unnecessary, since the peak would be higher in the next days and the user will anyway be charged for that peak. Figure 14 shows the consumption of the HP units.

The two-stage optimization process proposed in this paper offers a significant advancement over traditional continuous peak demand optimization approaches. By calculating an optimal peak demand in the first stage and using it as a fixed constraint in the second stage's real-time energy management, we align the optimization with actual energy usage and billing cycles. This strategy avoids the inefficiency of attempting to reduce a peak demand that has already occurred earlier in the billing cycle, thus providing a more tailored and effective energy management solution. The results from our case study demonstrate this method's superiority in practical scenarios, making it a more user-friendly and cost-efficient alternative to existing models.

6 | CONCLUSIONS

A two stage optimisation model is proposed in this paper to manage the energy consumption in smart buildings and reduce the monthly peak demand. The real-time pricing tariff and power-based peak tariff are considered in the model. In the first stage, the hourly flexibility of the demand is used to schedule the expected consumption, considering the tariff the peak consumption. The optimal value of the peak demand is considered in the second stage of the optimisation, and the model ensures that this value is not violated during the month.

Although the month ahead scheduling guarantees lower peak demand for the building, it can lead to an increase in the variance of the consumption profile. The demand variations are used to benefit from time variable electricity rates as well as reducing the peak to avoid higher monthly charges for the peak demand.

In future, considering a more advanced model for the flexibility characterization of the customer for the month ahead could increase the reliability of the decisions in the first stage. In other words, the optimal peak demand obtained in the first stage would be more realistic. This approach could be applied to a community level, where an aggregator or a retailer is making decisions for a group of customers.

NOMENCLATURE

Sets and indices

- A/a Set and index of uninterruptible electric devices
- B/b Set and index of time blocks for demand flexibility
- D/d Set and index of the days in the calendar month
- I/i Set and index of iterations of the rolling horizon approach
- T/t Set and index of time slots
- T^v Set of time periods that electric vehicle v is connected

- \mathcal{T}_b Set of time periods in block b
- \mathcal{V}/v Set and index of electric vehicles

Parameters

- η^{Cb} Charge efficiency of the ES/EV unit
- η^{Dcb} Discharge efficiency of the ES/EV unit
- λ Electricity price [€/kWh]
- λ_{peak} Monthly power-based network tariff [€/kW]
- τ Duration of time periods [h]
- ζ District heating energy price [\$/kWh]
- COP^{HP} Coefficient of performance of the heat pump
- D^{beat} Heat demand of the building [kW]
- P^{PV} Forecasted PV production [kW]
- P_{Dn} Lower limit of consumption profile [kW]
- P_{FT} Forecasted electricity consumption of the building loads [kW]
- $P_{Min/Max}^{Cb}$ Minimum/maximum charging power of the ES/EV battery [kW]
- $P_{Min/Max}^{Dcb}$ Minimum/maximum discharging power of the ES/EV battery [kW]
- $P_{NC}(t)$ Forecasted consumption of non-controllable load [kW]
- P_{Up} Upper limit of consumption profile [kW]
- SoC^{Max} Maximum allowed state of charge for the ES/EV battery [kWh]
- SoC^{Min} Minimum allowed state of charge for the ES/EV battery [kWh]

Variables

- MEC Monthly electricity cost [€]
- g Heat delivered to the building from the district heating network [kW]
- $p(t)$ Electric power drawn from the grid [kW]
- p^a Power consumption of appliance a [kW]
- p^{Cb} Charging power of the battery [kW]
- p^{Dcb} Discharging power of the battery [kW]
- p_{Max} Peak electric power drawn from the grid [kW]
- $SoC^{ES/EV}$ State of charge of the ES/EV battery [kWh]
- x^{Cb} Binary decision variable for the charging status of the ES
- x^{Dcb} Binary decision variable for the discharging status of the ES

AUTHOR CONTRIBUTIONS

Mohammad Ali Fotouhi Ghazvini was the main researcher in the project, and had performed the model development and simulations. Kyriaki Antoniadou-Plytaria has contributed in the simulations and model developments. David Steen and Le Anh Tuan were the main supervisors of the project and they have led the related research projects.

ACKNOWLEDGEMENTS

This work is financially supported by SN11 “Innovative energy management system for smart buildings and grid interactions” within the collaborative framework between Göteborg Energi AB and Chalmers University of Technology, H2020 FLEXIGRID project (Grant Agreement ID: 864048) and the I-GREta project.

CONFLICT OF INTEREST STATEMENT

The authors declare no conflicts of interest.

DATA AVAILABILITY STATEMENT

The data that support the findings of this study are available on request from the corresponding author. The data are not publicly available due to privacy or ethical restrictions.

ORCID

Mohammad Ali Fotouhi Ghazvini  <https://orcid.org/0000-0002-0638-7221>

REFERENCES

- Bellocchi, S., Manno, M., Noussan, M., Prina, M.G., Vellini, M.: Electrification of transport and residential heating sectors in support of renewable penetration: Scenarios for the Italian energy system. *Energy* 196, 117062 (2020)
- Xu, Y., Çolak, S., Kara, E.C., Moura, S.J., González, M.C.: Planning for electric vehicle needs by coupling charging profiles with urban mobility. *Nat. Energy* 3(6), 484–493 (2018)
- Wood, J., Funk, S.: Can demand response help reduce future distribution grid investments? In: An economic study of peak shaving in the Norwegian distribution grid: SEMIAH pilot in Engene, Sørlandet, Southern Norway (2017)
- Koski, A., Järvenpää, J., Salo, J., Järvinen, M., Pylvänäinen, J., Honkapuro, S.: Power-based tariff as an incentive for distribution system operator's customers to reduce their peak powers. In: 25th International Conference on Electricity Distribution, CIRED. IEEE, Piscataway (2019)
- Alizadeh, M., Moghaddam, M.P., Amjadi, N., Siano, P., Sheikh El Eslami, M.: Flexibility in future power systems with high renewable penetration: A review. *Renewable Sustainable Energy Rev.* 57, 1186–1193 (2016)
- Rodrigues, E., Godina, R., Santos, S., Bizuayehu, A., Contreras, J., Catalão, J.: Energy storage systems supporting increased penetration of renewables in islanded systems. *Energy* 75, 265–280 (2014)
- Hurtado, L., Rhodes, J., Nguyen, P., Kamphuis, I., Webber, M.: Quantifying demand flexibility based on structural thermal storage and comfort management of non-residential buildings: A comparison between hot and cold climate zones. *Appl. Energy* 195, 1047–1054 (2017)
- Ceseña, E.A.M., Capuder, T., Mancarella, P.: Flexible distributed multi-energy generation system expansion planning under uncertainty. *IEEE Trans. Smart Grid* 7(1), 348–357 (2016)
- Luo, F., Kong, W., Ranzi, G., Dong, Z.Y.: Optimal home energy management system with demand charge tariff and appliance operational dependencies. *IEEE Trans. Smart Grid* 11(1), 4–14 (2019)
- Merdanoğlu, H., Yakıcı, E., Doğan, O.T., Duran, S., Karatas, M.: Finding optimal schedules in a home energy management system. *Electr. Power Syst. Res.* 182, 106229 (2020)
- Reddy, T.A., Kreider, J.F., Curtiss, P.S., Rabl, A.: Heating and Cooling of Buildings: Principles and Practice of Energy Efficient Design. CRC Press, Boca Raton, FL (2016)
- Ghazvini, M.A.F., Soares, J., Abrishambaf, O., Castro, R., Vale, Z.: Demand response implementation in smart households. *Energy Build.* 143, 129–148 (2017)
- Godina, R., Rodrigues, E.M., Pouresmaeil, E., Catalão, J.P.: Optimal residential model predictive control energy management performance with pv microgeneration. *Comp. Oper. Res.* 96, 143–156 (2018)
- Wang, D., Zhang, X., Qu, K., Yu, T., Pan, Z., Liu, Q.: Pareto tribe evolution with equilibrium-based decision for multi-objective optimization of multiple home energy management systems. *Energy Build.* 159, 11–23 (2018)
- Qayyum, F., Naeem, M., Khwaja, A.S., Anpalagan, A., Guan, L., Venkatesh, B.: Appliance scheduling optimization in smart home networks. *IEEE Access* 3, 2176–2190 (2015)
- Su, Y., Zhou, Y., Tan, M.: An interval optimization strategy of household multi-energy system considering tolerance degree and integrated demand response. *Appl. Energy* 260, 114144 (2020)
- Moghaddam, I.G., Saniei, M., Mashhour, E.: A comprehensive model for self-scheduling an energy hub to supply cooling, heating and electrical demands of a building. *Energy* 94, 157–170 (2016)
- Li, R., Wei, W., Mei, S., Hu, Q., Wu, Q.: Participation of an energy hub in electricity and heat distribution markets: An mpec approach. *IEEE Trans. Smart Grid* 10(4), 3641–3653 (2019)
- Rastegar, M., Fotuhi Firuzabad, M., Zareipour, H., Moeini Aghtaich, M.: A probabilistic energy management scheme for renewable-based residential energy hubs. *IEEE Trans. Smart Grid* 8(5), 2217–2227 (2017)
- Lindberg, K.B., Doorman, G., Fischer, D., Korpås, M., Ånestad, A., Sartori, I.: Methodology for optimal energy system design of zero energy buildings using mixed-integer linear programming. *Energy Build.* 127, 194–205 (2016)
- Luthander, R., Widén, J., Nilsson, D., Palm, J.: Photovoltaic self-consumption in buildings: A review. *Appl. Energy* 142, 80–94 (2015)
- Wang, Y., Quan, Z., Zhao, Y., Wang, L., Jing, H.: Operation mode performance and optimization of a novel coupled air and ground source heat pump system with energy storage: Case study of a hotel building. *Renew. Energy* 201, 889–903 (2022)
- Seal, S., Boulet, B., Dehkordi, V.R., Bouffard, F., Joos, G.: Centralized mpc for home energy management with ev as mobile energy storage unit. *IEEE Trans. Sustainable Energy* 14(3), 1425–1435 (2023)
- Zou, W., Sun, Y., Gao, D.c., Zhang, X., Liu, J.: A review on integration of surging plug-in electric vehicles charging in energy-flexible buildings: Impacts analysis, collaborative management technologies, and future perspective. *Appl. Energy* 331, 120393 (2023)
- Junker, R.G., Azar, A.G., Lopes, R.A., Lindberg, K.B., Reynnders, G., Relan, R., et al.: Characterizing the energy flexibility of buildings and districts. *Appl. Energy* 225, 175–182 (2018)
- Bahrami, S., Wong, V.W.S., Huang, J.: An online learning algorithm for demand response in smart grid. *IEEE Trans. Smart Grid* 9(5), 4712–4725 (2017)
- Cellik, B., Roche, R., Bouquain, D., Miraoui, A.: Decentralized neighborhood energy management with coordinated smart home energy sharing. *IEEE Trans. Smart Grid* 9(6), 6387–6397 (2018)
- Zhu, Z., Lambotharan, S., Chin, W.H., Fan, Z., et al.: A game theoretic optimization framework for home demand management incorporating local energy resources. *IEEE Trans. Ind. Inf.* 11(2), 353–362 (2015)
- Eid, C., Koliou, E., Valles, M., Reneses, J., Hakvoort, R.: Time-based pricing and electricity demand response: Existing barriers and next steps. *Utilities Policy* 40, 15–25 (2016)
- Mancarella, P.: MES (multi-energy systems): An overview of concepts and evaluation models. *Energy* 65, 1–17 (2014)
- Soroudi, A.: Power System Optimization Modeling in GAMS. Springer, Cham (2017)
- Setthaolo, D., Sichilalu, S., Zhang, J.: Residential load management in an energy hub with heat pump water heater. *Appl. Energy* 208, 551–560 (2017)
- Silvente, J., Kopanos, G.M., Dua, V., Papageorgiou, I.G.: A rolling horizon approach for optimal management of microgrids under stochastic uncertainty. *Chem. Eng. Res. Des.* 131, 293–317 (2018)
- Khodabakhsh, R., Sirouspour, S.: Optimal control of energy storage in a microgrid by minimizing conditional value-at-risk. *IEEE Trans. Sustainable Energy* 7(3), 1264–1273 (2016)

35. HSB: HSB living lab (2020). <https://www.hsb.se/hsblivinglab/>
36. Nord Pool: Historical market data (2020). <https://www.nordpoolgroup.com/Market-data1/Intraday/Market-data1/Market-data1/Overview/?view=table>
37. Chalmers University of Technology: HSB Living Lab (2020). <https://hll.livinglab.chalmers.se/>
38. Antoniadou Plytaria, K., Srivastava, A., Ghazvini, M.A.F., Steen, D., Carlson, O., et al.: Chalmers campus as a testbed for intelligent grids and local energy systems. In: 2019 International Conference on Smart Energy Systems and Technologies (SEST), pp. 1–6. IEEE, Piscataway (2019)
39. Vattenfall: Guarantees of origin for electricity. <https://www.vattenfall.se/foretag/miljo/vara-energislav/ursprungsgarantier/>
40. Vattenfall: Choose how you want to receive your electricity bill - Vattenfall. <https://www.vattenfall.se/english/about-your-invoice/>
41. Reinhardt, A., Baumann, P., Burgstahler, D., Hollick, M., Chonov, H., Werner, M., et al.: On the accuracy of appliance identification based on distributed load metering data. In: Sustainable Internet and ICT for Sustainability (SustainIT), 2012, pp. 1–9. IEEE, Piscataway (2012)

How to cite this article: Fotouhi Ghazvini, M.A., Antoniadou-Plytaria, K., Steen, D., Tuan, L.A.: Two-stage demand-side management in energy flexible residential buildings. *J. Eng.* 2024, 1–14 (2024). <https://doi.org/10.1049/tje2.12372>