



## **Wire Harness Assembly Process Supported by a Collaborative Robot: A Case Study Focus on Ergonomics**

Downloaded from: <https://research.chalmers.se>, 2026-04-06 03:22 UTC

Citation for the original published paper (version of record):

Navas-Reascos, G., Romero, D., Rodriguez, C. et al (2022). Wire Harness Assembly Process Supported by a Collaborative Robot: A Case Study Focus on Ergonomics. *Robotics*, 11(6). <http://dx.doi.org/10.3390/robotics11060131>

N.B. When citing this work, cite the original published paper.

Article

# Wire Harness Assembly Process Supported by a Collaborative Robot: A Case Study Focus on Ergonomics

Gabriel E. Navas-Reascos <sup>1,\*</sup>, David Romero <sup>1,\*</sup>, Ciro A. Rodriguez <sup>2</sup>, Federico Guedea <sup>2</sup> and Johan Stahre <sup>3</sup><sup>1</sup> School of Engineering and Science, Tecnológico de Monterrey, Mexico City 14380, Mexico<sup>2</sup> School of Engineering and Science, Tecnológico de Monterrey, Monterrey 64849, Mexico<sup>3</sup> Division of Production Systems, Chalmers University of Technology, SE-412 96 Gothenburg, Sweden

\* Correspondence: gabriel.navas.reascos@gmail.com (G.E.N.-R.); david.romero.diaz@gmail.com (D.R.)

**Abstract:** Products and assets are becoming increasingly “smart”, e.g., mechatronic, electronic, or cyber-physical. In the lack of fully reliable wireless solutions, extensive wiring and wire bundling into wire harnesses are needed. This has manufacturing implications, leading to increasingly complex wire harness assembly processes, where numerous components, connectors, and cables are assembled, connecting critical and non-critical electric and electronic systems in smart products and assets. Thus, wire harnesses demand is rapidly rising in most industries, requiring human or robotic work. Often, required work tasks are repetitive and physically demanding, while still needing people for quality reasons. An attractive solution would therefore be humans collaborating with robots. Unfortunately, there are very few scientific studies on automation solutions using collaborative robots (cobots) for wire harness assembly process tasks to increase process productivity and improve work ergonomics. Furthermore, wire harness assembly process tasks are presently carried out 90% manually in this industry, causing serious ergonomic problems for assembly workers who perform such tasks daily. The challenge is reducing the ergonomic risks currently present in many established wire harness assembly processes while improving production time and quality. This paper presents an early prototype and simulation to integrate a cobot into a wire harness assembly process, primarily for work ergonomic improvements. The use of a cobot is specifically proposed to reduce ergonomic risks for wire harness assembly workers. Two methodologies: RULA and JSI were used to evaluate the ergonomics of the task of cable tie collocation. The real-world case study results illustrate the validation of a cobot which significantly reduced non-ergonomic postures in the task of placing cable ties in the wire harnesses assembly process studied. An ergonomic analysis without the cobot (the actual process) was conducted, based on RULA and JSI methodologies, presenting the highest possible scores in both evaluations, which calls for urgent changes in the current wire harness assembly process task studied. Then, the same analysis was performed with the cobot, obtaining significant reductions in the ergonomic risks of the task at hand to acceptable values.

**Keywords:** wire harness; assembly; collaborative robots; ergonomics; computer vision systems

**Citation:** Navas-Reascos, G.E.; Romero, D.; Rodriguez, C.A.; Guedea, F.; Stahre, J. Wire Harness Assembly Process Supported by a Collaborative Robot: A Case Study Focus on Ergonomics. *Robotics* **2022**, *11*, 131. <https://doi.org/10.3390/robotics11060131>

Academic Editor: Shafiqul Islam

Received: 12 October 2022

Accepted: 13 November 2022

Published: 16 November 2022

**Publisher's Note:** MDPI stays neutral with regard to jurisdictional claims in published maps and institutional affiliations.



**Copyright:** © 2022 by the authors. Licensee MDPI, Basel, Switzerland. This article is an open access article distributed under the terms and conditions of the Creative Commons Attribution (CC BY) license (<https://creativecommons.org/licenses/by/4.0/>).

## 1. Introduction

The *wire harness manufacturing industry* is currently being pressured to rapidly evolve to higher productivity levels through automation solutions because, at present, appliances, machinery, vehicles, and other products and assets are increasingly becoming “smart”. As a result of the *smartification* trend, products and assets are requiring more electric, electronic, and mechatronic systems, components, and parts to be connected for their functionality, causing increased demand for wire harnesses by most industries, leading to substantial growth in the workload of the wire harness assembly workers [1,2].

The objective of this work is to answer the research question of “how a wire harness assembly process can be semi-automated through the deployment of a collaborative robot (with a vision system) to improve ergonomics?”.

*Wire harness assembly processes* require a lot of manual effort and are time-consuming. These processes are one of the most challenging phases and operations in the manufacturing of products and assets that need these for their systems, components, and parts connectivity [3]. Most wire harness assembly process tasks are presently carried out manually, generating ergonomic and occupational health problems for assembly workers, due to repetitiveness and awkward postures [4]. Gualtieri et al. [4] claim that presently 90% of the wire harness assembly process tasks are conducted manually. Hence, it is necessary to urgently improve the performance of these “repetitive” and “manual” assembly process tasks, both from productivity and ergonomics perspectives.

*Collaborative robots (cobots)* have the potential to radically increase process productivity and improve ergonomic comfort for (assembly) workers. *Cobots* can also reduce the workload for humans as well as the time and cost of manual (assembly) process tasks [5]. However, Trommnau et al. [6], Heisler et al. [7], and Navas-Reascos et al. [8], who conducted three state-of-the-art reviews on *wire harness assembly process tasks supported by human–robot collaboration*, conclude that there are a very limited number of *cobot applications* aimed at improving the productivity and ergonomics of wire harness assembly processes.

One of the wire harness assembly process tasks found in the scientific literature that has been successfully automated through a *cobot* is the *spot-taping task*, as described by Gualtieri et al. [4] and Ibáñez et al. [9], wherein both technological developments were able to improve the productivity and ergonomics of this task. Later, Tunstel et al. [10] and Yumbra et al. [11] used a *cobot* to make two technological developments focused on the *male–female connection task* in a wire harness assembly process, realizing task productivity and quality improvements. Furthermore, Phi and Yoon [12] and Heisler et al. [13] concentrated on *wire-harness placing tasks* (on its assembly board) supported by a *cobot* and accomplishing substantial productivity gains.

*Cobot solutions* by Gualtieri et al. [4] and Ibáñez et al. [9] were made specifically for a specific type of wire harness. When the wire harness type changes, the programming of their *cobot* solution also needs to change. This limitation is relevant from a productivity perspective (i.e., changeovers) because of the variety of wire harness types that must be assembled/manufactured for the different “smart” products and assets being demanded in the market. Moreover, the research by Trommnau et al. [14] concludes that the *wire harness assembly process tasks* with more possibilities to effectively integrate a *cobot* with potential productivity, quality, and ergonomic gains are: (a) wire routing, (b) wire insertion, (c) cable tie collocation, and (d) adhesive tape taping; and these tasks need further research as identified by Navas-Reascos et al. [8].

According to Gualtieri et al. [4], Ibáñez et al. [9], and Capitanelli et al. [15], it is very difficult to make *robots* work with *flexible materials* (e.g., cables and wires), even sometimes hard for humans too. This is one of the reasons why it is so difficult to automate many wire harness assembly process tasks, and why most of the automation solutions focus only on tasks where the wire harness does not need to move.

The work by Gualtieri et al. [4] presents a conversion from a “manual” wire harness assembly workstation to a “collaborative” one aiming for safety, ergonomics, and efficiency improvements for the process and the assembly workers. They conducted this technological development for a specific type of wire harness, taping together three-wire groups using a taping pistol. They placed the *cobot* at the back of a collaborative workstation while the *assembly worker* remained in front of it, reducing in this way the possibility of collision (safety). They had the main objective of reducing the awkward postures for the assembly workers (ergonomics). The *cobot* works in two workstations, and it is placed between these two for higher productivity (efficiency). Gualtieri et al. [4] used the *Rapid Upper Limb Assessment (RULA) methodology* to evaluate the ergonomic gains of the task at hand, getting a reduction from six (left arm) and seven (right arm) to a value of three (in both arms) with the help of the *cobot*. They concluded that using a *cobot* can improve the ergonomics of the *spot-taping task* because the *cobot* will perform the most stressful sub-task which is the taping collocation, and the *assembly worker* will only conduct the sub-task of the wire

harness placing in its assembly board, allowing for the reduction of awkward postures and the number of movements performed by the worker.

In their proposed *human–robot collaborative solutions*, Gualtieri et al. [4] and Sugiono et al. [16] used the *RULA* and *Workplace Ergonomic Risk Assessment (WERA) methodologies*, respectively, to evaluate their ergonomic improvements to the *spot-taping task* in their studied wire harness assembly processes. The two evaluations show that wire harness assembly processes present dangerous ergonomic problems for the workers' occupational health. Sugiono et al. [16] determined that changing their studied wire harness assembly process was crucial. On the other hand, Gualtieri et al. [4] demonstrated that integrating a cobot into a wire harness assembly process as a "third hand" could significantly improve the workers' occupational health.

Furthermore, this paper presents an early prototype and simulation for integrating a *cobot* into a wire harness assembly process using a *computer vision system* to automate the cable ties collocation task flexibly. Hence, a *computer vision system* can allow working with different types and forms of wire harnesses without changing the *cobot programming*. Otherwise, the operator would have to change the cobot program for every wire harness model and batch, which is currently a common practice in the industry [13].

This paper is organized as follows: Section 1 presents an introduction to the wire harness assembly process and explores its compatibility with a *cobot* towards collaborative assembly solutions, Section 2 provides the background that guides this research and technological development, Section 3 details the materials and methods used in this work, Section 4 describes a collaborative robotics case study focused on ergonomics gains in a collaborative wire harness assembly process, Section 5 discusses the main findings of this investigation and trial, and Section 6 offers conclusions and further research.

## 2. Background

### 2.1. Wire Harness Assembly Process

*Wire harnesses* are used to join cables that are present in electrical equipment. In their fundamental part, the assembly of wire harnesses has not changed over time, even with the progress of manufacturing and assembly technologies [3].

A *wire harness* joins all the electronic components of a mechatronic or electronic product. It consists of a trunk that has all its cables joined together. The wires that get out of the trunk at several points are called "legs" [17]. Usually, the connectors at the ends of a wire are welded or crimped. Additionally, wire harnesses are bundled with straps, cable ties, and adhesive tape. The wires are protected by flexible tubing to reduce heat exposure and friction wear [5,14].

A generic *wire harness manufacturing process* is divided into the following activities: (a) preparation, (b) preproduction, (c) assembly, (d) testing, (e) storing, and (f) mounting in the final product [14,16,17].

The *preparation activity* encompasses the tasks of elaborating a "harness wiring diagram" with all the connections of the wire harness to be manufactured, and the development of a "CAD layout" indicating where the components and cables of the wire harness must be collocated; this CAD layout is later used to support the wire harness assembly activity. Next, the *preproduction activity* is composed of the following tasks: wire cutting, stripping, terminal attachment, and wire twisting. Followed by the *assembly activity tasks* where wires get routed, inserted in their connectors, covered with corrugated tubes, and collocated with adhesive tape or cable ties. Then, the *testing activity* verifies the correct operation of a wire harness, and if the tests are successful, a label is collocated in the wire harness. Lastly, the wire harness can be *stored* or brought directly to its final step of being *mounted* in a product [14,16,17].

Most of the tasks of the *preproduction* and *testing activities* in a wire harness manufacturing process are nowadays automatized. In contrast, the majority of the tasks of the *assembly activity* are presently completed manually. This situation presents an opportunity

to investigate how to automatize certain wire harness assembly tasks, for example, with the help of cobots [18].

## 2.2. Collaborative Robots

In current digitalization and automation trends, collaborative robots work next to operators in industrial settings [19]. *Collaborative robots (cobots)* can assist humans by learning multiple tasks. In contrast to *autonomous robots* that can only perform one task independently and are stationary [20].

*Industrial robots* have been working in production lines for a long time, but they work away and are shielded from humans because of the danger they could represent. New “collaborative robots” try to overcome this restriction [5]. These work shoulder-to-shoulder with humans to perform a task or series of tasks [21]. Using a *cobot* will decrease the number of tasks that a worker will perform and improve the quality and productivity of a process [9]. Collaborative robots have sensors that detect a collision, stopping the cobot under activation and avoiding harming humans [21,22]. However, *cobots*, robots in general, have problems working with flexible materials such as wire harnesses because of their low elastic modulus and bending, extensional, and torsional stiffness [6]. Other problems related to the integration of cobots into a wire harnesses assembly process are the absence of commercial-off-the-self technological solutions, the high number of parts to handle in their assembly, and the variety of types of wire harnesses in sizes and lengths that needed to be manufactured [4,5,10,11].

The advantages of working with cobots vs. manual operations in a production line are the following [21–24]:

- *Easy Programming*—The programming of traditional robots is harder than the programming of cobots. For example, a cobot could be moved manually to a specific position and this position could be recorded into the cobot navigation memory, making its trajectories (i.e., waypoints) programming easier.
- *Fast Setup*—Getting a traditional robot up and running can take days or even weeks while putting a cobot to run can be achieved in half an hour because this could simply be connected to a standard electrical wall outlet, and easily configured due to its intuitive programming interface.
- *Different Uses*—Assigning a new task to a cobot is easy because it is easy to program. For this reason, it can perform additional, multiple tasks in various business units according to the specific needs of a company. In contrast, traditional robots generally perform only one task and are hard to move around due to their fixed installation settings.
- *Accuracy*—Cobots are very accurate, unlike humans. Cobots will never perform an action that has not been programmed and will always perform a task with the same force.
- *Collaborative and Safe*—A cobot is designed to work with people, not replace them. A cobot can perform unsafe, repetitive, or boring tasks so workers can perform other more value-added tasks. Usually, a cobot has a security system to prevent accidents due to its close interaction with workers. It is equipped with force and collision sensors. Although a cobot cannot always avoid colliding with humans, its safety sensors reduce the force impacts and stop the cobot movement when bumping into a human. Safety plans can also be configured to limit the cobot’s working area.
- *Productivity*—Productivity often improves when utilizing a cobot because it reduces human errors and allows workers to focus on a more skilled task while the cobot does the repetitive task(s).

According to El Zaatari et al. [25] and Cesta et al. [26], there are various types of interactions between a cobot and a worker including the following:

- *Independent*—A cobot and an operator work on different workpieces. It is considered collaborative work because they work in the same space without a fence isolating the cobot.

- *Simultaneous*—A cobot and an operator work on the same workpieces but on separate tasks.
- *Sequential*—Tasks are performed sequentially between a cobot and an operator on the same workpieces.
- *Supportive*—A cobot and an operator simultaneously work on the same task and workpiece, under a collaboration scheme.

### 2.3. Ergonomics

*Ergonomics* is the engineering discipline responsible for designing workplaces, tools, and tasks to obtain the best anatomical and physiological characteristics to improve workers' comfort. It seeks to optimize the human environment with the help of artifacts [2].

The repetitive movements performed by industry workers could cause many problems in their occupational health, such as tenosynovitis, carpal tunnel, tendinitis, and De Quervain's disease, among others. These ergonomic problems are produced because they make an excessive effort and have awkward postures (i.e., poor ergonomics). The wire harness assembly process tasks are not an exception [1].

This research work considers two methodologies to evaluate the ergonomics of a wire harness assembly process task: RULA and *Job Strain Index (JSI)*.

*RULA methodology* offers a more robust ergonomics evaluation in comparison to the *WEIRA methodology*. The first one measures all upper body limb angles and considers other factors such as the muscular activity developed, and forces applied in the task at hand. In addition, the *JSI methodology* complements the *RULA methodology*, considering additional factors such as time and speed. Moreover, the *JSI methodology* informs if the workers could develop traumatism or injuries due to repetitive movements in their upper.

The *RULA methodology* helps to identify the risk factors involved in a high postural load when present in a worker's routine. It also recognizes ergonomic problems due to excessive postural load on the upper limbs of a worker. *RULA methodology* provides a score that determines if the work postures are acceptable or require changes, or even a complete redesign of the job tasks (see Table 1) [27].

**Table 1.** Levels of action needed according to the final RULA score [27].

Score	Performance
1 or 2	Acceptable risk.
3 or 4	Changes to the task may be required; it is convenient to deepen the study.
5 or 6	Task redesign required.
7	Urgent changes are required in the task.

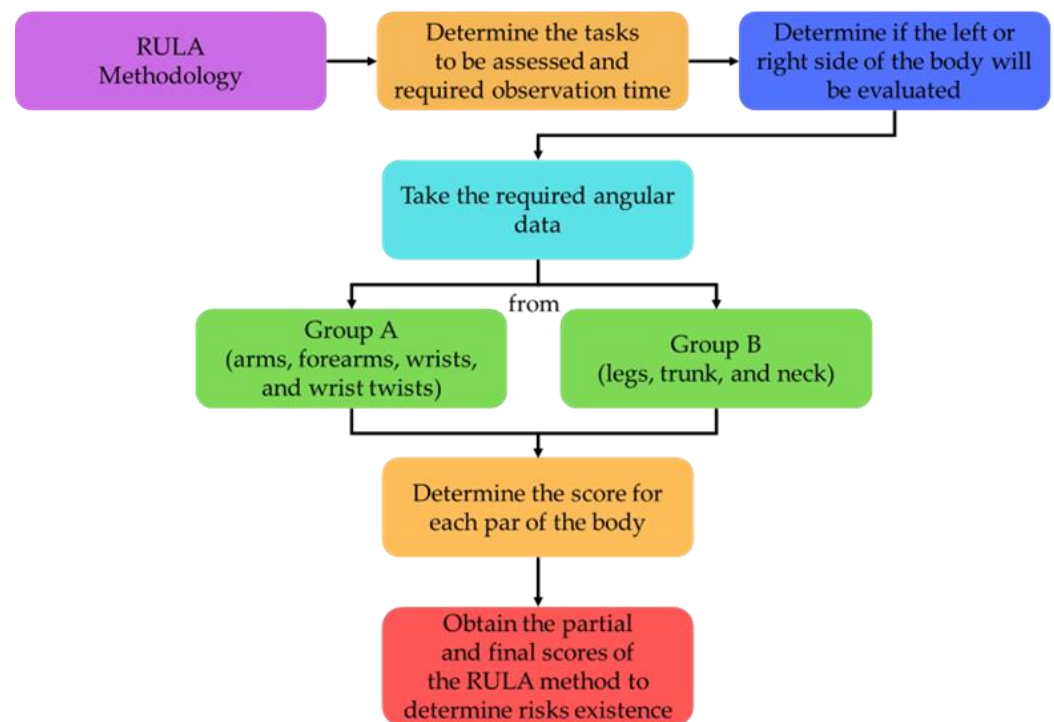
*RULA methodology* only evaluates individual postures and not a sequence of them in a job routine, so it is necessary to determine which postures should be considered. First, it has to be specified which postures will be evaluated. These are selected by looking at those with a more significant postural load based on their duration, frequency, and/or considerable deviation from their neutral position [27].

The postural load measurements are completed by calculating the angles of the different body parts with their determined reference. The tool RULER from the Ergonautas Research Group of the Polytechnic University of Valencia conducts these angle evaluations using photographs [27].

For calculating the RULA score, the human body is divided into two groups: Group A composed of arms, forearms, wrists, and wrist twists, and Group B composed of legs, trunk, and neck. A RULA score is assigned to each body part using the scoring tables proposed by the methodology. Then, general values are calculated for each group using the scores of each body part, also using scoring tables [27].

The musculoskeletal injury risk is determined with levels from 1 to 4. The final scores of each group are adapted according to the muscular activity developed and the forces applied in the task at hand. With these scores, the final values are calculated. "1" is

an acceptable posture, and “4” shows that a change is urgently required. All the *RULA methodology steps* can be seen in Figure 1 [27].



**Figure 1.** RULA methodology.

In a complementary way, the *JSI methodology* allows the evaluation of whether a worker could develop trauma or injuries caused by repetitive motion in his/her upper extremities due to the development of his/her activities. The *JSI methodology* measures six physical workload variables which are: the intensity of effort (*IE*), the duration of the effort per work cycle (*DE*), the number of efforts made in one minute of work (*EM*), the deviation of the wrist from the neutral position (*HWP*), the speed with which it is performed the task at hand (*SW*), and the duration of the same task per day (*DD*) [28].

The *JSI methodology* can help to determine the risk of developing musculoskeletal disorders, mainly in the hands and wrists [28].

The *JSI final score* is calculated with Equation (1) [28]:

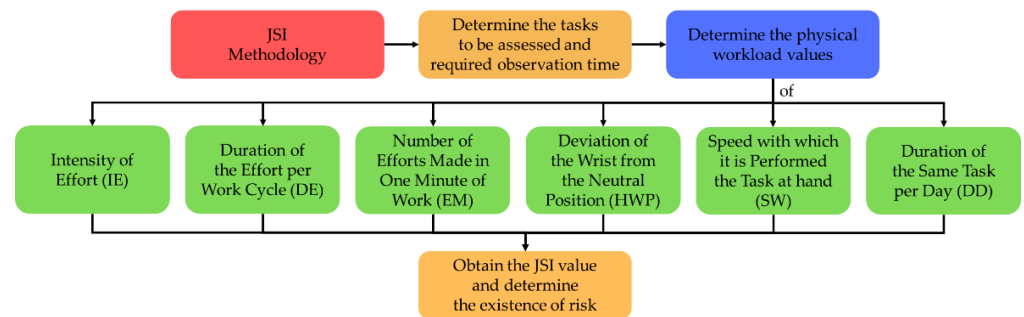
$$JSI \text{ final score} = IE \times DE \times EM \times HWP \times SW \times DD \quad (1)$$

If the *JSI score* values are less than or equal to “3”, these indicate that the task is probably safe. *JSI scores* greater than or equal to “7” indicate that the task is likely dangerous. Hence, scores higher than “5” are associated with musculoskeletal disorders of the upper extremities. All the *JSI methodology steps* can be seen in Figure 2 [28].

#### 2.4. Computer Vision System

*Computer vision* is the field where techniques are developed to help computers “see” and understand digital images, such as photographs, videos, icons, and anything else with pixels involved [29].

*Computer vision systems* are a subject of study in the area of automation. These allow the building of artificial systems capable of recovering information from an image and are used in several sectors such as defense, aerospace, automotive, and medical [30,31].



**Figure 2.** JSI Methodology.

A *robot vision system* aims to understand and recognize the environment through accurate and robust detection of objects, interacting with the environment to make decisions [32,33].

### 3. Materials and Methods

#### 3.1. Materials

The materials used in this research and development work were:

- *Universal Robots UR5*—is a collaborative robot (cobot) with six degrees of freedom with a highly flexible robotic arm that enables safe automation of repetitive, risky tasks [22];
- *RG2 by “On Robot”*—is a flexible 2-finger robot gripper. It was used to simulate the gripper that will place the cable ties; and
- *Cognex Camera IS7905M*—is a camera commonly used in computer vision applications in the industry because of its small size and modularity. Additionally, it allows a quick and precise inspection and detection of workpieces [34].

#### 3.2. Methods

Several methodological steps were considered in the development of this case study, searching for the integration of a cobot into the wire harness assembly process.

The focus of the R&D work is the *cable tie collocation task* because it is considered one of the wire harness assembly process tasks that normally causes bigger ergonomic problems. Moreover, it is important to mention that a cobot could also be used for improving ergonomics in other wire harness process tasks such as wire routing, covering the wire with corrugated tubes, and collocating adhesive tape.

For an actual *cable tie collocation task* in an industrial setting, RULA and JSI scores are “7” and “12”, respectively. This shows that the task is ergonomically poor. An example of the left arm angle with flexion of  $30^\circ$  is presented in Figure 3.



**Figure 3.** RULA left arm evaluation—this image is a representation of a real picture.

With the angles determined by the images of all the body parts, the values of Groups A and B were calculated according to the RULA methodology (see Figure 1). The value for Group A was “5”, and for Group B was “8”, getting a final RULA score of “7” (see RULA scoring table—Table 2).

**Table 2.** Final RULA Score Table.

Score A	Score B						
	1	2	3	4	5	6	7
1	1	2	3	3	4	5	5
2	2	2	3	4	4	5	5
3	3	3	3	4	4	5	6
4	3	3	3	4	5	6	6
5	4	4	4	5	6	7	7
6	4	4	5	6	6	7	7
7	5	5	6	6	7	7	7
8	5	5	6	7	7	7	7

The *JSI methodology* was also used for the evaluation of the *cable tie collocation task*; it presents a risk level of “12”, and the maximum level of risk allowed in this methodology is “7”. An example of wrist deviation is presented in Figure 4 getting an angle of 22°.



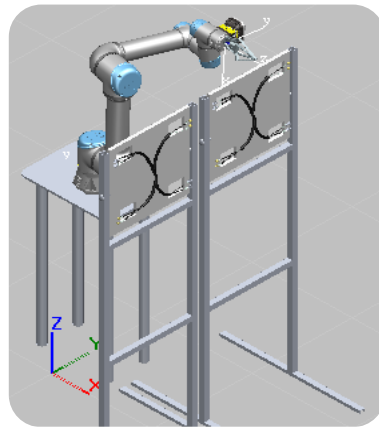
**Figure 4.** JSI wrist deviation evaluation—this image is a representation of a real picture.

Having obtained the values of  $IE = 1$ ,  $DE = 2$ ,  $EM = 3$ ,  $HWP = 2$ ,  $SW = 1$ , and  $DD = 1$  according to the *JSI methodology* detailed in Figure 2, the next step was to calculate the final value of the *JSI score* by replacing the values in Formula 1 getting Equation (2).

$$JSI = 1 \times 2 \times 3 \times 2 \times 1 \times 1 = 12 \quad (2)$$

The production manager of a Mexican enterprise dedicated to wire harness manufacturing was interviewed. She reported that *cable tie placement* is the process that generates more ergonomic health problems for her workforce. In the investigation by Gualtieri et al. [4], similar results were obtained in a different enterprise.

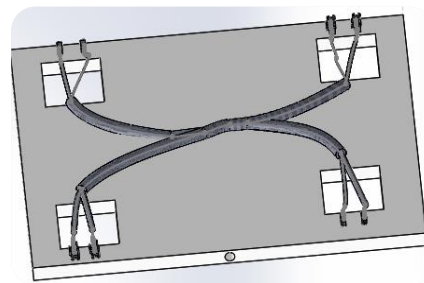
Then, a *workstation design* was developed where a cobot is on the back of the assembly board. For this design, it was necessary to modify the assembly boards by making some holds on them so the cobot will enter from behind to place the cable ties in the wire harness (see Figure 5). This workstation design was selected because the risk of collision between the worker and the cobot was eliminated since they do not work side-by-side. This design allows working on two boards simultaneously. While the worker is on Assembly Board 1, the cobot is on Assembly Board 2, and vice-versa.



**Figure 5.** Utilized workstation design.

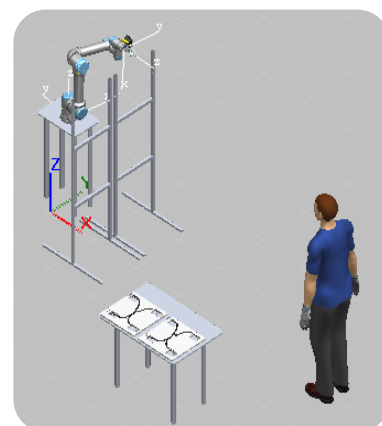
Next, a *computer vision system* was developed to identify the holes and their position in the wire harness assembly board. The Cognex camera software “In-Sight Explorer<sup>®</sup>” and “Polyscope<sup>®</sup>” for the UR5 cobot were used. First, it was necessary to interconnect the camera to the UR5 cobot and then to a computer. The integration needed a router to create a local network. Then, it was required to calibrate the camera with the cobot.

A simulation of the *collaborative wire harness assembly process* was carried out in “Tecnomatix<sup>®</sup> Plant Simulation”. Elements such as the workbench, the wire harness, and the assembly boards were needed; these elements were designed in “Solidworks<sup>®</sup>”. Finally, they were imported to “Tecnomatix<sup>®</sup> Plant Simulation”. The assembly of the wire harness into the assembly board is shown in Figure 6.



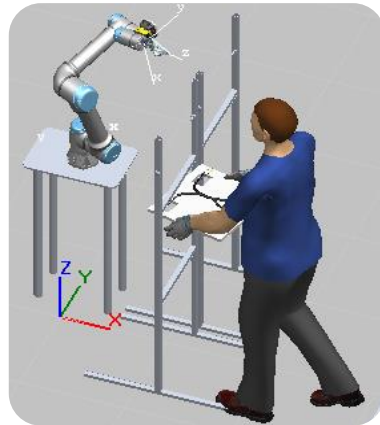
**Figure 6.** Wire harness assembly into the wire harness assembly board.

All the elements used in the simulation of the *collaborative wire harness assembly process* are shown in Figure 7.

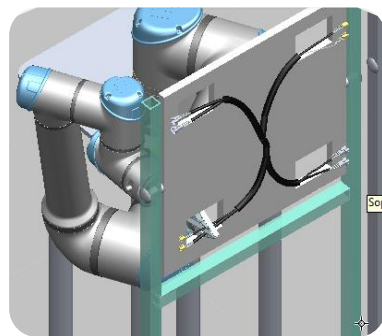


**Figure 7.** Wire harness assembly process elements used in the simulation.

First, the assembly worker will place the wire harness into the assembly board (see Figure 8). Next, the Cognex camera will take a photograph of the board to identify the number and positions of the holes and send this data to the cobot. Then, the cobot will process this data and determine the position of the holes in the board. Finally, the cobot will place one by one a cable tie in each identified hole (see Figure 9). Meanwhile, the worker places the other wire harness into the second assembly board.

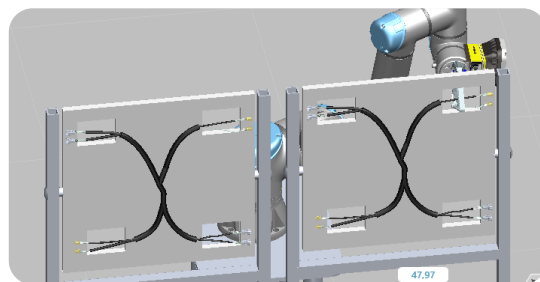


**Figure 8.** Placement of the wire harness assembly board in the workbench.



**Figure 9.** Cobot collocating the wire harness cable ties.

Lastly, when the cobot finishes collocating the cable ties in both wire harnesses (see Figure 10), it goes to its waiting position to repeat the task with other wire harnesses.

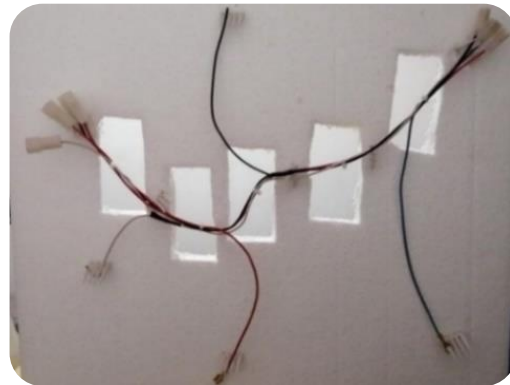


**Figure 10.** Cobot collocating cable ties.

The type of interaction between the cobot and the worker is *sequential* because they perform their assembly tasks independently and in sequence. They will work in the same wire harnesses but at different moments during their assembly process. The cobot will work on the first wire harness (WR1) attaching its cable ties and the operator will work on the second wire harness (WR2) placing it in the wire harness assembly board. Then, the cobot will work in the second wire harness (WR2) while the worker takes out the first wire harness (WR1) and places the next one (WRx).

#### 4. Case Study

This R&D work was completed in collaboration with a Mexican small-sized enterprise specialized in the manufacture of electrical, automotive, and industrial wire harnesses. Figure 11 shows the wire harness provided by the enterprise for the trial focused on integrating a cobot in support of the assembly worker in the cable tie collocation task. Additionally, Figure 11 presents the wire harness board prototype designed in Styrofoam that was developed to allow the cobot to work in the back of the assembly board while the assembly worker is in front of it.

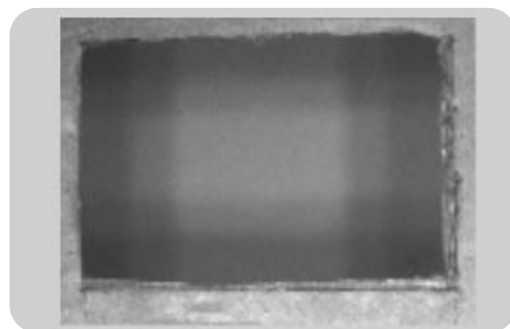


**Figure 11.** Wire harness assembly board (prototype).

This first approach to a collaborative solution presents a functional prototype of a human–robot collaborative workstation for the *cable tie collocation task*. This does not include a gripper solution that collocates the cable ties. The gripper was not developed. For this reason, the verification of the right collocation of the cable tie was not assessed.

##### 4.1. Collaborative Robot Programming

First, it was necessary to teach the camera the pattern to be identified. In this case, the holes in the wire harness assembly board (see Figure 12).



**Figure 12.** Teaching the pattern to the Cognex camera.

After taking a photograph with the camera, the holes identified by the *computer vision system* are shown in Figure 13.

The interconnection software of the camera with the cobot only sends the position of the identified holes one by one and not the total number of them. Due to this, it was necessary to make a Modbus communication to send the number of holes found by the camera to the cobot (see Figure 14).

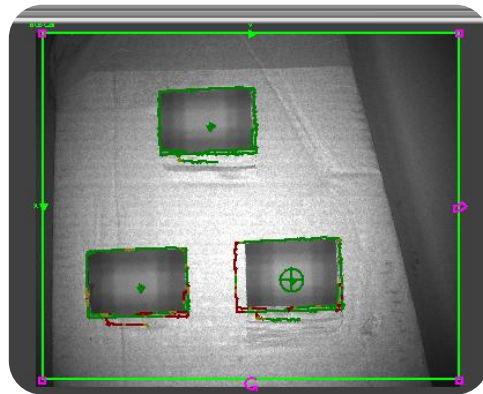


Figure 13. Holes identified with the camera.

IP address	192.168.0.101		
Type	Address	Name	Value
<input checked="" type="radio"/> Register Input	2005	MODBUS_1	3

Figure 14. UR5 Modbus communication.

The cobot program that emulates the *cable tie collocation task* for this wire harness was designed in Polyscope<sup>®</sup>. The program works for two different wire harness assembly boards. The second board was proposed by the authors only as a testing example.

First, it is necessary to select which assembly board the cobot will work on. Then, the cobot moves the camera to the selected assembly board position, takes photographs, and identifies the number of holes and their positions. Next, the data are sent to the cobot for its processing. Finally, the cobot moves and enters every hole and emulates the *cable tie collocation* (see Figure 15).



Figure 15. Emulation of the cable tie collocation task.

The whole process to carry out the cable tie collocation task with the support of a cobot is described in Figure 16.

#### 4.2. Ergonomic Evaluation with the Cobot

Finally, the *ergonomics analysis* of the *cable tie collocation task* with cobot support was conducted based on the *RULA* and *JSI scores*. An example of the left arm with flexion of 10° can be seen in Figure 17. With the angles determined by the images of all the body parts, the values of Groups A and B were calculated according to the *RULA methodology* (see Figure 1). The value for Group A was “3”, and for Group B was “4”, getting a *final*

RULA score of “4” (see RULA scoring table cobot—Table 3). This score is significantly lower when compared to the original manual operation without cobot assistance (RULA score of “7”).

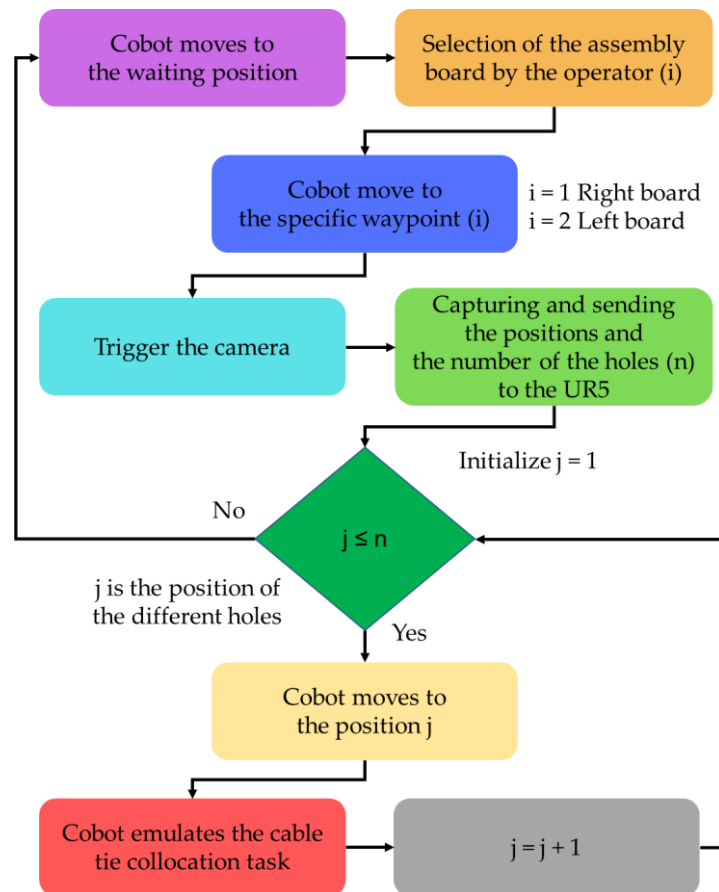


Figure 16. Cobot process diagram for cable ties collocation.

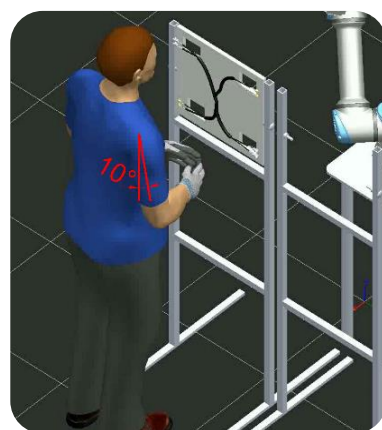
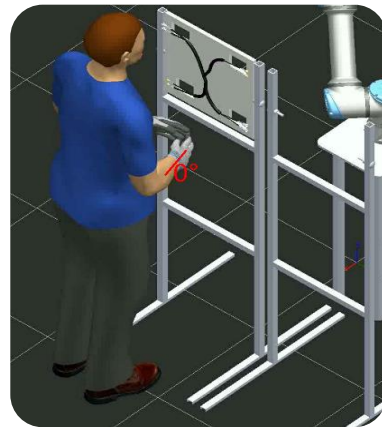


Figure 17. Left arm evaluation with cobot support—this image is a representation of a real picture.

**Table 3.** RULA score table with cobot support.

Score A	Score B						
	1	2	3	4	5	6	7
1	1	2	3	3	4	5	5
2	2	2	3	4	4	5	5
3	3	3	3	4	4	5	6
4	3	3	3	4	5	6	6
5	4	4	4	5	6	7	7
6	4	4	5	6	6	7	7
7	5	5	6	6	7	7	7
8	5	5	6	7	7	7	7

The *JSI methodology* was also used for the evaluation of the *cable tie collocation task*; it presents a risk level of “4.5”, which is lower than the maximum level of risk allowed in this methodology which is “7”. An example of wrist deviation is presented in Figure 18 obtaining an angle of 0°.

**Figure 18.** Wrist deviation with cobot support—this image is a representation of a real picture.

Having obtained the values of  $IE = 1$ ,  $DE = 1.5$ ,  $EM = 3$ ,  $HWP = 1$ ,  $SW = 1$ , and  $DD = 1$  according to the *JSI methodology* detailed in Figure 2, the next step was to calculate the final value of the *JSI score* by replacing the values in Formula 1 getting Equation (3).

$$JSI = 1 \times 1.5 \times 3 \times 1 \times 1 \times 1 = 4.5 \quad (3)$$

*RULA* and *JSI evaluations* showed an essential improvement in the ergonomic posture of the assembly workers using a cobot in support of the cable tie collocation task.

## 5. Discussion

To answer the research question of this work, it was first necessary to study the wire harness assembly process state-of-the-art. Trommnau et al. [6], Heisler et al. [7], and Navas-Reascos et al. [8] conducted a state-of-the-art review on *wire harness assembly process tasks supported by human–robot collaboration*, finding that there is limited research on using *cobots* in support of the *wire harness assembly process*, providing an excellent opportunity to further research this topic. Therefore, it is essential to consider how to automate or semi-automate the wire harness assembly process tasks particularly due to its poor ergonomics for the assembly workers.

This R&D work was made with a focus on the *cable tie collocation task*, which is similar to the studies carried out by Gualtieri et al. [4] and Ibáñez et al. [9]. In the three cases, the assembly worker was responsible for placing the wire harness on the assembly board to avoid the difficulties that cobots have in handling flexible materials, such as a wire harness.

It is demonstrated that the *cable tie collocation task* presents relevant ergonomic problems for the wire harness assembly workers according to the results of *RULA* and *JSI methodologies*. Using a *cobot* could improve the assembly workers' ergonomics at work, therefore, their occupational health, reducing risks also according to the *RULA* and *JSI methodologies* in comparison to the manual cable tie collocation task.

The investigations by Gualtieri et al. [4] and Sugiono et al. [16] also developed an *ergonomic evaluation* for the *cable tie collocation task*, the first one with the *RULA methodology*, and the second one with the *WERA methodology*. However, these two *methodologies* only allow evaluating individual postures, not groups or sequences of these. The *JSI methodology* provides a better assessment since it also considers other factors such as the number of efforts made in one minute of work, the duration of the effort per work cycle, the speed with which it is performed the task at hand, and the duration of the same task per day. Integrating these two *methodologies* allows a deeper ergonomic analysis of the assembly workers in the *cable tie collocation task*.

The case study shows that the *cable tie collocation task* could be semi-automated, improving the workers' ergonomics, because it presented a reduction in the two methodologies, *RULA* and *JSI*. *RULA* from "7" to "4" and *JSI* from "12" to "4.5". Changing from values that show that the task could present occupational health problems to acceptable risk values according to the methodologies. These results can be seen in Table 4.

**Table 4.** Comparison between manual and collaborative assembly processes.

Method	Manual Assembly	Collaborative Assembly
RULA	7	4
JSI	12	4.5

On the other hand, the collaborative solutions proposed by Gualtieri et al. [4] and Ibáñez [9] are similar to the ones proposed in this work. Nevertheless, their *cobot* solution can only work in one specific type of wire harness without providing versatility (flexibility); this is a crucial limitation in the wire harness manufacturing industry due to the use of different types and forms of wire harnesses [13]. In their solutions, the software developer should change the programming in the *cobot* every time the type of wire harness is changed. Hence, the integration of a *computer vision system* into the proposed collaborative solution allows working with different types and shapes of wire harnesses without changing the *cobot* programming.

The biggest technical problem related to the computer vision system programming was that the camera could not work on the Z-axis of the workspace of the workbench in the camera-robot calibration process; this was from the cartesian coordinate system perspective of the *cobot*. This is why the calibration process had to be carried out in the X-Y plane of the *cobot*. To correct this issue, it was necessary to generate two planes in the *cobot* program code and transform the coordinates that are in the X-Y plane to the Y-Z plane.

Issues to explore in the future include: (a) the design of a specialized gripper needed for the *cable tie collocation task* and its integration into a *cobot* arm; three possible approaches for developing it are (i) to adapt the existing hand tool for the task to a *cobot*, (ii) adapt an existing robot gripper for this task, or (iii) develop a new specialized robot gripper for the task; (b) the establishment of an industrial safety protocol for the assembly workers that will allow them to work securely with the collaborative robot in the *cable tie collocation task*; and (c) the analysis the *cable tie collocation task cycle time* using a collaborative robot and without it for productivity purposes.

## 6. Conclusions

Limited research and technological development was found in the scientific literature on the use of *collaborative robots* in the *wire harness assembly process* [6–8]. This represents an excellent opportunity for further research in this area since there are few robotics systems developments in support of the wire harness assembly workers.

The approach presented in this work showed that a collaborative robot could be integrated into the *wire harness assembly process task of cable tie collocation*, improving the assembly workers' ergonomics for this task.

The study shows that a collaborative robot in the *cable tie collocation task* provides benefits such as reducing non-ergonomic postures. These postures were evaluated using RULA and JSI methodologies. This task requires urgent changes since it has a maximum level of risk of "7" in the RULA methodology score and the JSI methodology score presents a risk level of "12", and the maximum level of risk allowed to avoid occupational health problems for the (assembly) worker is "7". When this task is automated using a cobot, the ergonomic risk is reduced to "4" in the RULA methodology score and "4.5" in the JSI methodology score; levels that are acceptable risk values.

According to the assessment provided by the RULA and JSI methods, the *worker's postures* in the proposed collaborative assembly process are *more ergonomic* than those currently carried out in the existing process.

Using a cobot reduces the number of non-ergonomic tasks carried out by an operator since the cobot will perform the most repetitive and awkward postures related to the process. Additionally, the cobot reduces ergonomic problems related to operating heavy hand tools for 8 h. In the case study, the hand tool for cable tie placement weighs 2 kg.

The collaborative solution presented in this paper also provides high versatility (flexibility) because the computer vision system allows adaptation to different wire harnesses and batches. However, it is crucial to calibrate the camera with high accuracy because the movements of the cobot should be precise, particularly for cable tie collocation tasks.

The computer vision system implementation allows a more viable adoption of the collaborative solution by the wire harness manufacturing industry since it will allow quick changeovers between different types of wire harnesses, without stopping the collaborative assembly operation.

**Author Contributions:** Conceptualization, G.E.N.-R., D.R., C.A.R., F.G. and J.S.; methodology, G.E.N.-R., D.R., C.A.R., F.G. and J.S.; validation, G.E.N.-R. and D.R.; formal analysis, G.E.N.-R., D.R., C.A.R., F.G. and J.S.; investigation, G.E.N.-R., D.R., C.A.R., F.G. and J.S.; resources, D.R.; data curation, G.E.N.-R.; writing—original draft preparation, G.E.N.-R. and D.R.; writing—review and editing, G.E.N.-R., D.R., C.A.R., F.G. and J.S.; visualization, G.E.N.-R., D.R., C.A.R., F.G. and J.S.; supervision, D.R.; project administration, D.R.; funding acquisition, D.R. All authors have read and agreed to the published version of the manuscript.

**Funding:** This research received no external funding.

**Institutional Review Board Statement:** Ethical review and approval were waived for this study due to its focus on the task and not the human.

**Informed Consent Statement:** Informed consent was obtained from all subjects involved in the study.

**Data Availability Statement:** Not applicable.

**Acknowledgments:** Not applicable.

**Conflicts of Interest:** The authors declare no conflict of interest.

## References

1. Realyvásquez-Vargas, A.; Arredondo-Soto, K.C.; García-Alcaraz, J.L.; Márquez-Lobato, B.Y.; Cruz-García, J. Introduction and Configuration of a Collaborative Robot in an Assembly Task as a means to Decrease Occupational Risks and Increase Efficiency in a Manufacturing Company. *Robot. Comput. Integr. Manuf.* **2019**, *57*, 315–328. [CrossRef]
2. Gannon, M. Making Connector Assembly Safer, Efficient with Workplace Ergonomics. *Connector Tips*. **2019**. Available online: <https://www.connectortips.com/making-connector-assembly-safer-and-more-efficient-with-workplace-ergonomics/> (accessed on 11 November 2022).
3. Aguirre, E.; Ferreira, L.; Raucent, B. Robotic Assembly of Wire Harnesses: Economic and Technical Justification. *J. Manuf. Syst.* **1997**, *16*, 220–231. [CrossRef]

4. Gualtieri, L.; Palomba, I.; Merati, F.A.; Rauch, E.; Vidoni, R. Design of Human-centered Collaborative Assembly Workstations for the Improvement of Operators' Physical Ergonomics and Production Efficiency: A Case Study. *Sustainability* **2020**, *12*, 3606. [CrossRef]
5. Coban, M.; Gelen, G. Realization of Human-Robot Collaboration in Hybrid Assembly Systems by Using Wearable Technology. In Proceedings of the 6th International Conference on Control Engineering and Information Technology (CEIT), Istanbul, Turkey, 25–27 October 2018; pp. 25–27.
6. Trommnau, J.; Frommknecht, A.; Siegert, J.; Wößner, J.; Bauernhansl, T. Design for Automatic Assembly: A New Approach to Classify Limp Components. *Procedia CIRP* **2020**, *91*, 49–54. [CrossRef]
7. Heisler, P.; Utsch, D.; Kuhn, M.; Franke, J. Optimization of Wire Harness Assembly using Human-Robot-Collaboration. *Procedia CIRP* **2020**, *97*, 260–265. [CrossRef]
8. Navas-Reascos, G.E.; Romero, D.; Stahre, J.; Caballero-Ruiz, A. Wire Harness Assembly Process Supported by Collaborative Robots: Literature Review and Call for R&D. *Robotics* **2022**, *11*, 65.
9. Ibáñez, V.R.; Pujol, F.; Ortega, S.G.; Perpiñán, J.S. Collaborative Robotics in Wire Harnesses Spot Taping Process. *Comput. Ind.* **2021**, *125*, 103370. [CrossRef]
10. Tunstel, E.; Dani, A.; Martínez, C.; Blakeslee, B.; Mendoza, J.; Saltus, R.; Trombetta, D.; Rotithor, G.; Fuhlbrigge, T.; Lasko, D.; et al. Robotic Wire Pinning for Wire Harness Assembly Automation. In Proceedings of the 2020 IEEE/ASME International Conference on Advanced Intelligent Mechatronics (AIM), Boston, MA, USA, 6–10 July 2020; pp. 1208–1215.
11. Yumbla, F.; Yi, J.S.; Abayebas, M.; Shafiyev, M.; Moon, H. Tolerance Dataset: Mating Process of Plug-in Cable Connectors for Wire Harness Assembly Tasks. *Intell. Serv. Robot.* **2020**, *13*, 159–168. [CrossRef]
12. Nguyen, T.P.; Yoon, J. A Novel Vision-based Method for 3D Profile Extraction of Wire harness in Robotized Assembly Process. *J. Manuf. Syst.* **2021**, *61*, 365–374. [CrossRef]
13. Heisler, P.; Steinmetz, P.; Yoo, I.S.; Franke, J. Automatization of the Cable-Routing-Process within the Automated Production of Wiring Systems. *Appl. Mech. Mater.* **2017**, *871*, 186–192. [CrossRef]
14. Trommnau, J.; Kühnle, J.; Siegert, J.; Inderka, R.; Bauernhans, T. Overview of the State of the Art in the Production Process of Automotive Wire Harnesses, Current Research and Future Trends. *Procedia CIRP* **2019**, *81*, 387–392. [CrossRef]
15. Capitanelli, A.; Maratea, M.; Mastrogiovanni, F.; Vallati, M. On the Manipulation of Articulated Objects in Human-Robot Cooperation Scenarios. *Rob. Auton. Syst.* **2018**, *109*, 139–155. [CrossRef]
16. Sugiono, S.; Efranto, R.Y.; Budiprasetya, A.R. Reducing Musculoskeletal Disorder (MSD) Risk of Wiring Harness Workstation using Workplace Ergonomic Risk Assessment (WERA) Method. *Sci. Rev. Eng. Environ. Sci.* **2018**, *27*, 536–551. [CrossRef]
17. Aguirre, E.; Raucant, B. Economic Comparison of Wire Harness Assembly Systems. *J. Manuf. Syst.* **1994**, *13*, 276–288. [CrossRef]
18. Yumbla, F.; Abeyabas, M.; Luong, T.; Yi, J.S.; Moon, H. Preliminary Connector Recognition System based on Image Processing for Wire Harness Assembly Tasks. In Proceedings of the 20th International Conference on Control, Automation and Systems (ICCAS), Busan, Republic of Korea, 13–16 October 2020; pp. 1146–1150.
19. Rauch, E.; Linder, C.; Dallasega, P. Anthropocentric Perspective of Production before and within Industry 4.0. *Comput. Ind. Eng.* **2020**, *139*, 105644. [CrossRef]
20. Rouse, M. Collaborative Robot (Cobot). 2018. Available online: <https://whatis.techtarget.com/definition/collaborative-robot-cobot> (accessed on 11 November 2022).
21. Dobra, Z.; Dhir, K.S. Technology Jump in the Industry: Human-Robot Cooperation in Production. *Ind. Robot Int. J. Robot. Res. Appl.* **2020**, *47*, 757–775. [CrossRef]
22. Faccio, M.; Bottin, M.; Rosati, G. Collaborative and Traditional Robotic Assembly: A Comparison Model. *Int. J. Adv. Manuf. Technol.* **2019**, *102*, 1355–1372. [CrossRef]
23. Universal Robots (UR). Why Cobots? 2021. Available online: <https://www.universal-robots.com/products/collaborative-robots-cobots-benefits/> (accessed on 11 November 2022).
24. Wired Workers. Universal Robots UR5. 2020. Available online: <https://wiredworkers.io/universal-robots-ur5/#:~:text=> (accessed on 11 November 2022).
25. El Zaatari, S.; Marei, M.; Li, W.; Usman, Z. Cobot Programming for Collaborative Industrial Tasks: An Overview. *Rob. Auton. Syst.* **2019**, *116*, 162–180. [CrossRef]
26. Cesta, A.; Orlandini, A.; Bernardi, G.; Umbrico, A. Towards a Planning-based Framework for Symbiotic Human-Robot Collaboration. In Proceedings of the IEEE 21st International Conference Emerging Technologies and Factory Automation (ETFA), Berlin, Germany, 6–9 September 2016; pp. 1–8.
27. Universidad Politécnica de Valencia (UPV). RULA. 2021. Available online: <https://www.ergonautas.upv.es/metodos/rula/rula-ayuda.php> (accessed on 11 November 2022).
28. Universidad Politécnica de Valencia (UPV). JSI. 2021. Available online: <https://www.ergonautas.upv.es/metodos/jsi/jsi-ayuda.php> (accessed on 11 November 2022).
29. Brownlee, J. Machine Learning Mastery. 2019. Available online: <https://machinelearningmastery.com/what-is-computer-vision/> (accessed on 11 November 2022).
30. Tsarouchi, P.; Makris, S.; Chryssolouris, G. Human–Robot Interaction Review and Challenges on Task Planning and Programming. *Int. J. Comput. Integr. Manuf.* **2016**, *29*, 916–931. [CrossRef]

31. Voulodimos, A.; Doulamis, N.; Doulamis, A.; Protopapadakis, E. Deep Learning for Computer Vision: A Brief Review. *Comput. Intell. Neurosci.* **2018**, *2018*, 7068349. [[CrossRef](#)] [[PubMed](#)]
32. Lim, J.H.; Kuc, T.Y. Intelligent Hybrid Hierarchical Architecture based Object Recognition system for Robust Robot Vision. In Proceedings of the International Conference on Control, Automation and Systems (ICCAS), Seoul, Republic of Korea, 14–17 October 2008; pp. 2130–2133.
33. Oliver, N.; Rosario, B.; Pentland, A. A Bayesian Computer Vision System for Modeling Human Interactions. *Lect. Notes Comput. Sci.* **1999**, *1542*, 255–272.
34. Corporation, C. Especificaciones IN-SIGHT 7000. 2020. Available online: <https://www.cognex.com/es-mx/products/machine-vision/2d-machine-vision-systems/in-sight-7000-series/specifications> (accessed on 11 November 2022).