



Integration of ICN and MEC in 5G and Beyond Networks: Mutual Benefits, Use Cases, Challenges, Standardization, and Future Research

Downloaded from: <https://research.chalmers.se>, 2026-04-06 04:08 UTC

Citation for the original published paper (version of record):

Gur, G., Kalla, A., de Alwis, C. et al (2022). Integration of ICN and MEC in 5G and Beyond Networks: Mutual Benefits, Use Cases, Challenges, Standardization, and Future Research. IEEE Open Journal of the Communications Society, 3: 1382-1412. <http://dx.doi.org/10.1109/OJCOMS.2022.3195125>

N.B. When citing this work, cite the original published paper.

© 2022 IEEE. Personal use of this material is permitted. Permission from IEEE must be obtained for all other uses, in any current or future media, including reprinting/republishing this material for advertising or promotional purposes, or reuse of any copyrighted component of this work in other works.

Integration of ICN and MEC in 5G and Beyond Networks: Mutual Benefits, Use Cases, Challenges, Standardization, and Future Research

Gürkan Gür, *Senior Member, IEEE*, Anshuman Kalla, *Member, IEEE*, Chamitha de Alwis, *Senior Member, IEEE*, Quoc-Viet Pham, *Member, IEEE*, Khac-Hoang Ngo, *Member, IEEE*, Madhusanka Liyanage, *Senior Member, IEEE*, Pawani Porambage, *Member, IEEE*

Abstract—Multi-access Edge Computing (MEC) is a novel edge computing paradigm that moves cloud-based processing and storage capabilities closer to the mobile users by implementing server resources in the access nodes. MEC helps fulfill the stringent requirements of 5G and beyond networks to offer anytime-anywhere connectivity for many devices with ultra-low delay and huge bandwidths. Information-Centric Networking (ICN) is another prominent network technology that builds on a content-centric network architecture to overcome host-centric routing/operation shortcomings and to realize efficient pervasive and ubiquitous networking. It is envisaged to be employed in Future Internet including Beyond 5G (B5G) networks. The consolidation of ICN with MEC technology offers new opportunities to realize that vision and serve advanced use cases. However, various integration challenges are yet to be addressed to enable the wide-scale co-deployment of ICN with MEC in future networks. In this paper, we discuss and elaborate on ICN MEC integration to provide a comprehensive survey with a forward-looking perspective for Beyond 5G networks. In that regard, we deduce lessons learned from related works (for both 5G and Beyond 5G networks). We present ongoing standardization activities to highlight practical implications of such efforts. Moreover, we render key B5G use cases and highlight the role for ICN MEC integration for addressing their requirements. Finally, we layout research challenges and identify potential research

directions. For this last contribution, we also provide a mapping of the latter to ICN integration challenges and use cases.

Index Terms—Multi-Access Edge Computing (MEC), Information-Centric Networking (ICN), Beyond 5G (B5G)/6G Networks, B5G/6G use cases, Network Softwarization, Internet of Things (IoT), Standardization, Edge Intelligence, Blockchain, B5G/6G security.

I. INTRODUCTION

The formidable performance requirements of 5G networks such as Gbps access bandwidths, 1-millisecond latency, 90% reduction in network energy usage and cost efficiency have led to the *Multi-access Edge Computing (MEC)* concept which optimizes the spatial layout of network applications and services by utilizing pervasive computing, communication and storage resources in or close to the edge of mobile networks [1], [2]. By pushing computing capabilities closer to subscribers, MEC enables low-latency and high-bandwidth access to content, applications, and services [3]–[5]. Mobile operators can deploy new revenue generating services for content delivery, Internet of Things (IoT) connectivity, retail, and enterprise applications quickly and effectively by leveraging MEC [6]. Accordingly, MEC Market is expected to reach USD 2.8 Billion by 2027, growing at a CAGR of 30.1% from 2020 [7]. In 2020, the largest share of the MEC market belonged to the large enterprises due to the increased generation of data with their widespread geographical presence and customer base. Thus, MEC has been touted as an essential element of 5G networks and attracted significant attention in the research community [8].

The benefits of MEC are expected to be exacerbated with the emergence of Beyond 5G (B5G) systems where new services and technologies require a much more elaborate edge computing infrastructure [3]. Moreover, these networks will be integral parts of the Internet ecosystem, with much tighter coupling and integration than 5G networks. Hence, the challenges faced by them are also valid for the Internet infrastructure in a trend: burgeoning data demands, the dominance of multimedia traffic, cost efficiency requirements, and exponentially increasing access bandwidths [9]. Accordingly, related solution efforts have led to numerous proposals for Future Internet protocols and architectures [10]. Although various improvements such as CDNs (Content Delivery Networks) and P2P (Peer-to-Peer) overlays have already been deployed through the current

Gürkan Gür is with the Zurich University of Applied Sciences (ZHAW), Switzerland. e-mail: gueu@zhaw.ch

Anshuman Kalla is with CGPIT, Uka Tarsadia University, India. e-mail: anshuman.kalla@ieee.org

Pawani Porambage is with the Centre for Wireless Communications, University of Oulu, Finland email: pawani.porambage@oulu.fi

Chamitha de Alwis is with the Department of Electrical and Electronic Engineering, University of Sri Jayewardeneprua, Sri Lanka, email: chamitha@sjp.ac.lk

Quoc-Viet Pham is with the Korean Southeast Center for the 4th Industrial Revolution Leader Education, Pusan National University, Busan 46241, Korea (e-mail: vietpq@pusan.ac.kr).

Khac-Hoang Ngo is with the Department of Electrical Engineering, Chalmers University of Technology, 41296 Gothenburg, Sweden. He is also with Advanced Institute of Engineering and Technology (AVITECH), University of Engineering and Technology, Vietnam National University Hanoi, Vietnam. (e-mail: ngok@chalmers.se).

Madhusanka Liyanage is with the School of Computer Science, UCD, Ireland and the Centre for Wireless Communications, University of Oulu, Finland. e-mail: madhusanka@ucd.ie, madhusanka.liyanage@oulu.fi

This research is funded by the Academy of Finland under 6Genesis Flagship (grant 318927) project and by Science Foundation Ireland under Connect Center (13/RC/2077_P2) Project. The work of Quoc-Viet Pham is supported by a National Research Foundation of Korea (NRF) Grant funded by the Korean Government (MSIT) under Grant NRF-2019R1C1C1006143, and in part by BK21 Four, Korean Southeast Center for the 4th Industrial Revolution Leader Education.

A preliminary version of this work was published in IEEE Communications Standards Magazine in Dec. 2020 [1].

Internet, more substantial architectural changes are evident for addressing the explosion of video, and P2P traffic [11]–[13]. *Information-Centric Networking (ICN)* is an Internet architecture that puts information at the center where it needs to be and replaces the client-server model by proposing a new publish-subscribe model [14]. In that setting, the network’s critical communication service is the dissemination of content requested by the end-point acting as a consumer.

According to Cisco VNI Report 2018, IP video traffic will be 82% of all IP traffic globally by 2022, up from 75% in 2017 [15]. The repercussions of this phenomenon are already evident. For instance, the over-the-top (OTT) video streaming service Netflix was 15% of the total downstream traffic volume across the entire Internet in 2018 [16]. Moreover, this substantial shift towards content consumption will be accompanied by the situation where smartphone traffic will exceed PC traffic [15]. While this content-dominant load will heavily tax the wireless networks, especially at the mobile edge, and MEC is instrumental in tackling emerging challenges, MEC itself has to evolve to a information/content-centric paradigm to realize its full potential in B5G networks. In that regard, ICN as a networking substrate in the network edge will ease the challenges for MEC-enabled applications under these circumstances [17]–[19]. Content-oriented services like UHD (Ultra High Density) video delivery or information consumption services like IoT analytics will benefit from such an information-centric architecture [20]–[22]. Moreover, that integration will boost the benefits promised by MEC, such as reduced latency, decreased network traffic, and improved security [23]. To implement this converged system efficiently in future networks, there are key research questions regarding how to support mobility, utilize network softwarization and network slicing, implement context awareness, and address the application characteristics (e.g., efficient provisioning of connection-oriented applications in information-centric architecture) [1], [24]–[26].

A. Paper Motivation

Essentially, the integration of ICN into MEC environment is greatly beneficial for efficient realization of B5G objectives, which spurs us to investigate the prospects for coupling of ICN and MEC, and analyze relevant technical works in this survey. To this end, we discuss related concepts and elaborate on how they can be integrated at the edge of future networks through some key use cases. Albeit its merits, this integration also has its own obstacles and challenges, which we also discuss later in the context of lessons learned and future research directions.

Although there are various well-structured surveys in this domain, there is a need to compile, analyze and synthesize the contributions/outcomes of related literature in the cross-fertilization of ICN, MEC and B5G networks as summarized in Table II. As one of the first comprehensive surveys, Xylomenos et al. [27] has presented an overview on ICN which is not tailored for B5G networks. It was published in 2012, and thus lacks new advances in this field. As a more recent work, Serhane et al. [36] provided a detailed survey on ICN naming and caching including MEC domain and in 5G and

TABLE I
SUMMARY OF IMPORTANT ACRONYMS

| Acronym | Definition |
|---------|--|
| 5G | Fifth Generation |
| 6G | Sixth Generation |
| AI | Artificial Intelligence |
| AP | Access Point |
| API | Application Program Interface |
| AR | Augmented Reality |
| B5G | Beyond 5G |
| CAV | Connected Autonomous Vehicles |
| CCN | Content-Centric Networking |
| CDN | Content Delivery Network |
| C-RAN | Cloud-RAN |
| DoS | Denial of Service |
| FIB | Forwarding Information Base |
| H2H | Hospital-to-Home |
| ICN | Information-Centric Networking |
| IETF | Internet Engineering Task Force |
| IIoMT | Intelligent Internet of Medical Things |
| IoE | Internet of Everything |
| IoT | Internet of Things |
| IoV | Internet of Vehicles |
| ITU | International Telecommunication Union |
| MCC | Mobile Cloud Computing |
| MEC | Multi-access Edge Computing |
| ML | Machine Learning |
| MNO | Mobile Network Operator |
| MR | Mixed Reality |
| NDN | Named Data Networking |
| NFV | Network Function Virtualization |
| NOMA | Non-Orthogonal Multiple Access |
| OTT | Over-The-Top |
| PDU | Protocol Data Unit |
| PoP | Point of Presence |
| QC | Quantum communication |
| QoE | Quality of Experience |
| QoS | Quality of Service |
| RAN | Radio Access Network |
| RSU | Road Side Unit |
| SDN | Software-Defined Networking |
| UAV | Unmanned Aerial Vehicle |
| UE | User Equipment |
| uHDD | ultrahigh Data Density |
| umMTC | ultra-massive Machine Type Communication |
| URLLC | Ultra Reliable and Low Latency Communication |
| UHD | Ultra High Definition |
| V2X | Vehicle-to-everything |
| VNF | Virtual Network Function |
| VR | Virtual Reality |
| XR | Extended Reality |
| ZSM | Zero-touch network and Service Management |

Beyond 5G. However, the main focus of that work is content naming and caching rather than a thorough integration aspect. In the MEC field, Mao et al. [28] provided a survey on communication in MEC. Recently, Pham et al. [3], Filali et al. [29] and Haibeh et al. [37] authored comprehensive surveys on MEC with a 5G perspective in 2020 but they does not focus on ICN integration with MEC. In [33], Grewe et al. present a detailed futuristic vehicular scenario with ICN in combination with MEC. However, it focuses on a single use-case (vehicular networks). In [34], Franklin et al. discusses the evolution, architecture, current standardization activities, and use cases of MEC in cellular networks but it is limited to 4G and 5G with a cellular network perspective. In [35], Liu et al. provides an overview of the role of MEC in 5G and IoT and elaborates on MEC for 5G and IoT. However, they do not cover the integration of ICN and MEC for B5G.

Similarly, in [38], Porambage et al. discusses MEC for IoT realization and how MEC is instrumental for IoT realization without ICN aspect and Beyond 5G perspective. Taking into account this situation, in our survey, we cover both ICN's and MEC's roles with recent and up-to-date works and also analyze them from a B5G perspective. Although there are significant but disparate contributions to tackle the related questions, our comprehensive survey is the first to consolidate and synthesize the lessons learned from the related works to address this cross-domain gap.

B. Our Contribution

As MEC and ICN are key enabler technologies for 5G and B5G networks, it is paramount to identify and elaborate on their potential benefits, integration within and towards other technologies, and various emerging opportunities and challenges. Therefore, this paper ventures to investigate, survey and thoroughly explore the body of work in the technical literature. In essence, the main contributions of this survey are:

- **To explore the relevant emerging applications, requirements and key use cases in the confluence of B5G networks, MEC technologies, and ICN paradigm:** We identify the key connected digital services/applications in a B5G network environment, and from the perspective of use cases, we render the relation of such applications and requirements which are relevant for MEC and ICN

technologies. This is important to explore the utility of ICN and MEC for future networks like B5G systems.

- **To investigate how MEC and ICN may alleviate the technical challenges in B5G networks and serve use cases:** We highlight the key aspects of MEC and ICN and then elaborate on the gains and benefits brought by integrating them in a future network setting. This treatment provides a realistic and guiding common ground for the integration related aspects discussed in the following parts of our work.
- **To identify the architectural aspects of MEC and ICN integration into B5G networks:** Although MEC and ICN are promising complementary technologies, their efficient integration into future networks still needs further research efforts. Starting from a 5G point, we present a prospective baseline architecture for realizing ICN and MEC in a mobile network and discuss its elements for future networks including B5G systems. This contribution is important to comprehend the mutual benefits of MEC and ICN integration to tackle the B5G requirements.
- **To delineate key challenges and future research directions based on the lessons learned:** MEC and ICN technologies are still being actively investigated and developed, but rather independently. Furthermore, the integration of ICN and MEC is an open question for future networks. We present key challenges and future research directions for these goals, based on the lessons learned in our work.

TABLE II
RELATED SURVEYS.

| Work | Description | What is missing wrt. our survey? |
|---|---|--|
| Xylomenos et al. 2013 [27] | A comprehensive survey on ICN | Not tailored for B5G networks, published in 2012 (new advances missing) |
| Mao et al. 2017 [28] | A survey on communication in MEC | Focuses on MEC and the communication aspect |
| Pham et al. 2020 [3], Filali et al. 2020 [29] | Comprehensive surveys on MEC with a 5G perspective | Very comprehensive surveys but focuses on MEC |
| Taleb et al. 2017 [30], Spinelli et al. [31] | Comprehensive surveys on MEC architecture, multi-tenancy and specifications (Verticals perspective in [31]) | Focuses mainly on MEC specifications and orchestration, no ICN aspect |
| Mach et al. 2017 [32] | Architectural analysis and computation offloading perspective | Focuses on computational offloading in MEC and no ICN aspect |
| Grewe et al. 2017 [33] | Presents a detailed futuristic vehicular scenario with ICN in combination with MEC | Focuses on a single use-case (vehicular networks) |
| Franklin et al. 2020 [34] | Discusses the evolution, architecture, current standardization activities, and use cases of MEC in cellular networks | Limited to 4G and 5G with a cellular network perspective |
| Liu et al. 2020 [35] | Provides an overview of the role of MEC in 5G and IoT | Elaborates on MEC for 5G and IoT, but does not cover the integration of ICN and MEC for B5G |
| Serhane et al. 2020 [36] | Provides a detailed survey on ICN naming and caching including MEC domain and in 5G and Beyond 5G | A comprehensive survey but MEC treatment is limited and the main focus is content naming and caching |
| Haibeh et al. 2022 [37] | Presents MEC aspects like dimensioning, virtualization and placement from the perspective of auto-scaled and proactive MEC-NFV infrastructure | Provides a MEC framework analysis based on ETSI MEC reference architecture but focuses solely on MEC |
| Porambage et al. 2018 [38] | Presents an extensive overview on MEC and IoT realization | Focuses mainly on IoT and how MEC is instrumental for IoT realization, no ICN aspect |
| Our survey | Goes beyond 5G and presents MEC and ICN integration for future networks comprehensively, considers B5G use cases and applications, provides an up-to-date synthesis of available technical literature, project works and standardization | - |

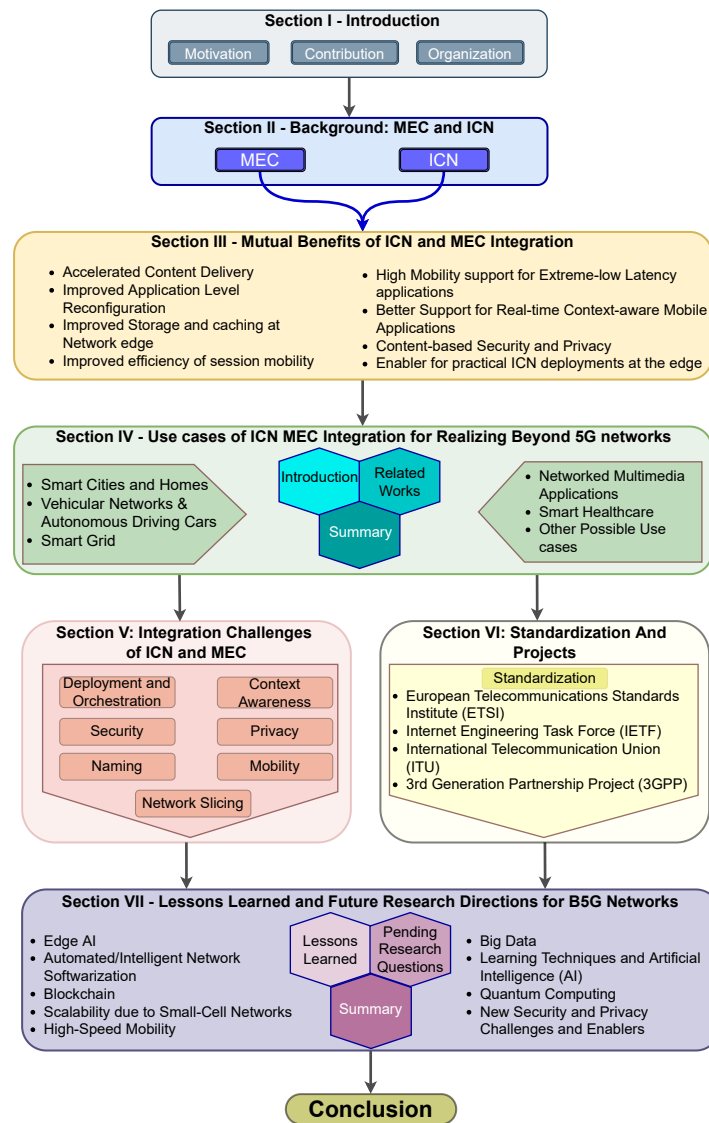

Fig. 1. Paper organization.

C. Paper Organization

The organization of our paper is shown in Fig. 1 and described as follows. A summary of important acronyms is given in Table I. Section II presents the key properties of MEC and ICN. Section III elaborates on the mutual benefits of MEC and ICN integration such as faster content delivery, edge optimizations, mobility support and content-based security. Section IV underlines the uses cases of ICN MEC to make our arguments for the premise of ICN MEC in future networks such as B5G more tangible. Section V discusses the obstacles and challenges on the road to information-centric realization of MEC, e.g., what makes it challenging, how to maximize advantages while tackling with some key issues such as security, privacy, context awareness and naming. Section VI presents standardization activities while Section VII describes future research directions of ICN MEC for B5G networks. In that latter section, we also provide the link between these research directions and ICN MEC challenges and B5G use cases in Table V. Finally, Section VIII concludes this paper.

II. BACKGROUND: MEC AND ICN

In this section, we provide a preliminary to the two emerging technologies: MEC and ICN.

A. Multi-access Edge Computing

1) *MEC Framework:* MEC is an extension of cloud computing towards the edge of the mobile communication network [39]. A framework for MEC was proposed by the ETSI MEC Industry Specification Group (ISG) to define the structure, entities and functions of MEC [30], [40]. This framework is defined under three levels:

Mobile edge system level: The underlying MEC system is abstracted in the mobile edge system level for user equipment and services to access the MEC system.

Mobile edge host level: This level consists of the mobile edge platform and the virtualization infrastructure to facilitate mobile edge applications.

Network level: The network level provides the connectivity to MEC through various connectivity methods including the Internet, local networks and mobile networks.

2) *Characteristics of MEC:* MEC exhibits several key characteristics as summarized below [3], [40], [41]:

Proximity: MEC infrastructure is located at the edge of the network in close proximity to users and IoT devices that utilize MEC services. This allows obtaining data from mobile and IoT devices to perform analytics using *Big Data* and *Small Data* processing techniques.

Low latency: Being located at the network edge, MEC is accessible with low latency required by delay-sensitive applications. Also, MEC enables mobile and IoT devices to access processing and storage resources available in the MEC in near real-time.

High bandwidth: MEC being deployed at the edge of the network requires less data transmissions towards the cloud due to raw data being processed at the network edge. This also reduces the communication overload and optimizes the backhaul bandwidth utilization of mobile networks.

Location awareness: Since MEC is located in close proximity to users, it is capable of using the information obtained from smart devices and IoT sensors and devices to learn the precise location in order to provide location-based services.

Real-time access to radio network information: MEC is capable of utilizing contextual information along with real-time radio network conditions to enhance the Quality of Service (QoS) and QoE of the services provided.

3) *MEC Applications:* The characteristics of MEC enable several emerging applications. For instance, Augmented Reality (AR)/Virtual Reality (VR)/Mixed Reality (MR) applications cannot be practically delivered through centralized service architectures in the network core [42]. Another example is performing distributed data reduction and security functions for IoT networks [38]. Other use cases include video distribution, content caching, data analytics, edge network optimization, and delay-sensitive applications and services such as gaming and connected autonomous vehicles. Furthermore, advanced security applications and urban monitoring in smart cities are able to perform crowd analysis of large numbers of people owing to MEC capabilities [43]. In addition, the resilience of mobile networks can be enhanced by providing connectivity and essential services through the edge network in case of a disaster. This resilience dimension will be imperative with the omnipresent role of 5G networks and foreseen digital services. MEC also ignites novel verticals for Mobile Network Operators (MNO) in 5G and B5G networks. This is through promoting more network connected applications and services while causing a minimal impact on the backhaul and the core networks. Furthermore, resource-constrained mobile and IoT devices are empowered to perform advanced functionalities beyond device capabilities, such as network and application analytics [44]. These functionalities are performed with minimal cloud bandwidth utilization while efficiently using existing network resources. MEC also aids to overcome operational challenges of mobile networks, especially in overcoming bandwidth bottlenecks [45].

B. Information-Centric Networking

ICN has emerged as a promising future networking paradigm to intrinsically reconcile existing issues of TCP/IP networking like mobility, named-host, availability, security, connection overheads, and management of traffic surge [46]. It is essentially an Internet architecture that puts information at the center and replaces the host-centric model with the content-centric model [26]. The basic idea of ICN is to enrich network-layer functions with the features like named-content, in-network caching, data-level security, name-based routing, multipath routing, and pull-based communication [14], [27].

1) *Interest and Data Packets:* As a prominent ICN proposal, Content-Centric Networking (CCN) puts forward two types of packets for communication: *Interest* packet and *Data* packet [46], [47]. The interest packet represents a request sent out by a host (consumer) to retrieve a particular content. In response, what it gets is a data packet which represents the requested content. In order to use the networking resources at its best, an interest packet window can be used where multiple interest packets are sent back-to-back without waiting for the data packet corresponding to the first interest packet [46]. Flow balance is maintained by real time optimization of interest window, i.e., how many multiple interest packets should be sent out in one go.

2) *Named Content:* *Named-content* (or service) is the most innovative offering of ICN. The idea is to decouple name from its location and to establish it as an identifier of a content (unlike being locator of a content in TCP/IP). A name (identifier) in place of IP address (locator) within a data packet enables the network elements (or nodes) to know what the content is traversing through them. Hence, named-content introduces intelligence within the networking ecosystem and allows downstream nodes, interested for the same content, to share the ongoing data flow resulting in better bandwidth utilization. Since the nodes could read the name of a requested content, several interest packets for the same content, reaching a particular node, could be replaced (aggregated) with only one interest packet which needs to be forwarded to next hop (upstream). In response to the interest, when the data packet reaches at this node, it gets replicated to all the interfaces which received the requests.

3) *In-Network Caching:* In-network caching is another important core feature of ICN. ICN takes caching to the core of networks by implementing it at network layer. The existence of named-contents in ICN gives in-network caching a superiority over web-caching and Content Delivery Network (CDN) since named-contents inculcate content consciousness within the network nodes thereby allowing them to be cognizant of what is flowing through it, what is being cached and what is being requested. Various types of in-network caching include on-path, off-path, edge and hybrid caching [48], [49].

4) *Data Structures and Functionalities:* Three data structures introduced by CCN at each network node are (i) Pending Interest Table (PIT) which maintains the list of interfaces which have received interest packets with the same name prefix (i.e., requesting the same content), (ii) Forwarding Information Base (FIB) holds the list of interfaces which can be used to send out interest packet(s) to fetch a content,

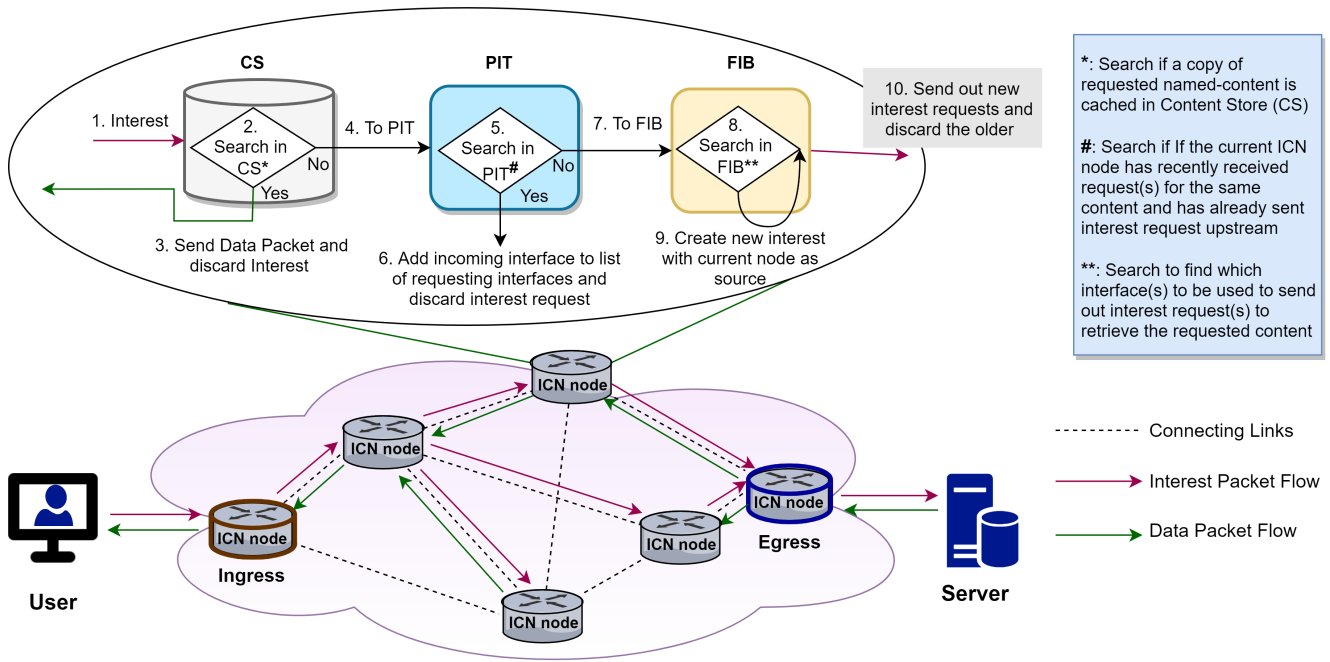

Fig. 2. Flow of interest packet and data packets in CCN [50].

and (iii) Content Store (CS) provides facility to store named-contents. Unlike the ephemeral buffers in IP routers which are recycled once the packets are forwarded, the CS in CCN nodes can retain the named-content as long as it is useful. This is to say, since a named-content is independent of location, any CCN node that caches a named-content can be a secondary point-of-source and can serve that content. Thus, CS in CCN aims for high cache hit rate which is achieved by strategically retaining the most demanding the content.

The basic flow of interest and data packets in CCN is depicted in Fig. 2. CCN node upon receiving an interest packet from anyone of its interface first checks its CS. If the data is available, then a copy of the content is sent as a response and this ends the quest of interest packet. Else, an entry corresponding to the requested content along with the requesting interface is made in the PIT of that node. Furthermore, based on FIB entries, the CCN node forwards upstream the same interest packet with a little modification that the current node now becomes the source (i.e., consumer) of the interest packet. When the interest packet meets the content, a reply in form of data packet is sent. The trajectory of this data packet downstream towards the requester(s) is governed by PIT states maintained by intermediate nodes. Any intermediate node when receives a data packet, depending on the caching policy may cache the data in CS and then forwards a copy of that data packet based on the entries in PIT, to node(s) downstream that requested the data. The data packet only back tracks the path that was followed by the interest packet and hence, it is the interest packet which is actually forwarded as per the routing information (FIB).

III. MUTUAL BENEFITS OF ICN AND MEC INTEGRATION

The synergy between ICN and MEC provides various functionalities for 5G and prospective B5G networks as shown

in Fig. 3. Furthermore, Fig. 4 presents the key benefits of ICN and MEC integration in B5G networks, which we render in the following segment.

1) *Accelerated content delivery:* One of the fundamental motives behind the development of MEC is to support the delay sensitive (low latency) applications. This requires faster and efficient content migration from cloud servers to the MEC server at the edge of the network. The use of ICN can enable the high speed content migration between the MEC nodes and central cloud systems due to its core functionalities such as in-network caching and named-content. The former functionality allows ICN capable nodes (all or selected nodes) to cache the content traversing them based on the caching policy. The latter functionality makes the network conscious of content being cached and requested. An interest request for the data which is not available at MEC server when sent upstream towards cloud server can be satisfied at any intermediate ICN node which holds a cached copy of the requested content. Thus, the request needs not to travel all the way to cloud server thereby speeding up the content delivery. This benefit can be further improved by implementing latency-aware in-network caching like Latency Aware Caching (LAC) [51]. LAC aims to cache with higher probability the contents that need to be fetched from distant servers.

2) *Improved application level reconfiguration:* Depending on the need of the offered services, MEC-NFV integrated architecture may need to add, upgrade or delete the VNFs which are softwarized components. This process is called as application level reconfiguration. Here application level reconfiguration stands for addition and/or removal of software components (i.e., VNFs) to support an application. MEC based service applications may request the addition and/or removal VNFs (or application level reconfiguration) at any point of

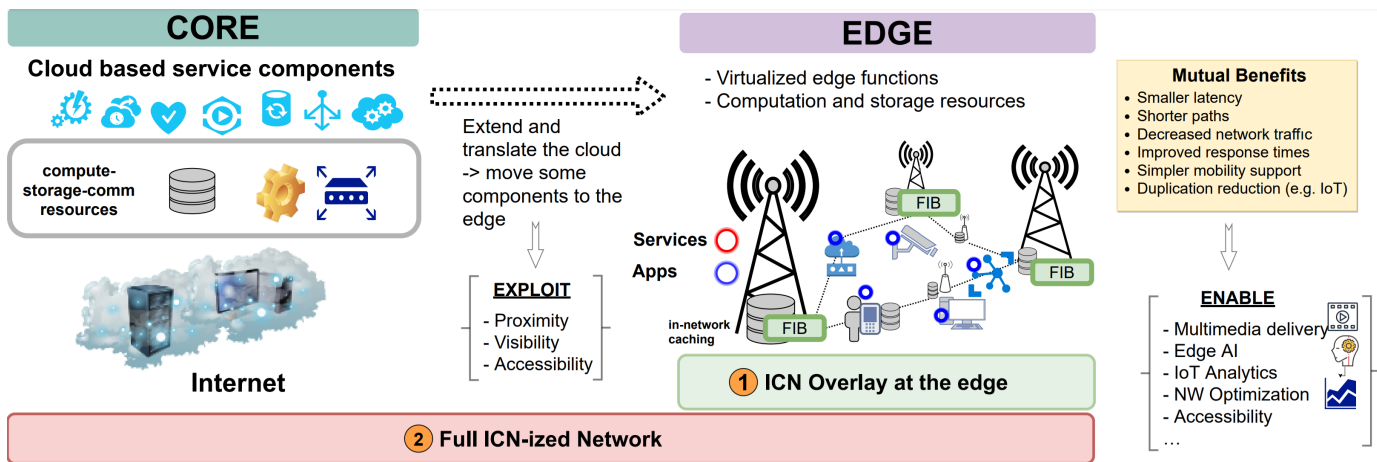

Fig. 3. ICN and MEC integration in a future mobile network. ICN is instrumental for enabling edge computing scenarios ① while it can act as a foundational networking technology in the future ②.

time depending on the need or due to non-compliance of promised performance [52].

In MEC systems, a session re-initialization or application level reconfiguration is triggered whenever a session is being served by a non-optimal service instance. Particularly, the mobility of MEC users will lead to network level changes in that leads such situations more often. However, application level reconfiguration in MEC systems can be challenging. Specially, the overhead occurs in terms of session re-initialization which potentially impairs the low-latency applications.

However, ICN can improve application level reconfiguration in MEC systems by minimizing the network configuration delay for MEC applications. Thanks to service-centric networking characteristics of ICN technology, it enables fast resolution of named-based service instances [53], [54]. Therefore, ICN, if tightly integrated in B5G networks, has the potential to handle the application-level reconfiguration for MEC-enabled services.

3) *Improved storage and caching at the network edge:* MEC is able to cache frequently used popular contents at the edge of the network to provide low-delay access while minimizing the burden to the core network [3]. Conversely, ICN is able to utilize MEC to improve the efficiency of storage and caching functions at the edge nodes in the network. This is mainly performed by banking on key ICN characteristics such as location independent naming, opportunistic caching and data replication performed strategically in the network, and cache being ubiquitous and transparent to applications [55]. Therefore, the integration of MEC and ICN is complementary to each other towards improving storage and caching functions at the network edge. This serves both realtime and non-realtime 5G and B5G applications, in case a set of users consume the same content [53].

4) *Improved efficiency of session mobility:* ICN introduces ubiquitous in-network caching to reduce network load and improve Quality of Service (QoS) of services. This feature is instrumental to reduce bandwidth utilization for signaling traffic for session mobility management in MEC system. MEC is able to facilitate enhanced session mobility, especially when

the client requests are directed towards the same replica of data stored using in-network caching [56]. Also, the session mobility management in MEC is able to reduce the bandwidth utilization for signaling traffic. The utilization of ICN significantly improve session mobility in MEC networks while reducing the operational cost. In contrary to the anchor-based mobility in MEC, ICN uses a split between name resolution and application identifier for mobility management. With the use of location split and application bound identifier, ICN is able to reduce the overheads of user and control planes of MEC session mobility events significantly to efficiently handle host mobility [1]. Furthermore, ICN is able to reliably maintain mobility in connection oriented sessions as the communication is explicit at the network level. Also, it is not necessary to re-establish a connection in case of the re-location of a host [57]. Therefore, the integration of MEC and ICN will be mutually beneficial in improving the session mobility efficiency in future mobile networks.

5) *High mobility support for extreme-low latency applications:* MEC systems are also advantageous in exploiting context-aware data distribution. The real time context aware applications could be accomplished with the correct coordination between MEC platforms. ICN provides considerable opportunities for context-aware data distribution in the networks by allowing content distribution over unreliable radio links and transparent mobility between heterogeneous network [58], [59]. Since the latency stems from RAN and core network as well as the backhaul between them, the cooperation of MEC and caching technologies can be employed to reduce the latency significantly [60].

Due to the latency support of MEC, ICN MEC integration is important to provide services for high mobility B5G applications such as tactile Internet and autonomous vehicles [61]. MEC can facilitate the intelligent and sophisticated mechanisms that accompany ICN in high-mobility regimes for addressing requirements such as latency-focused caching of transient contents in vehicular information-centric networks or cooperative cache implementations as virtualized functions at the edge [62]. To this end, a smart cache management strategy

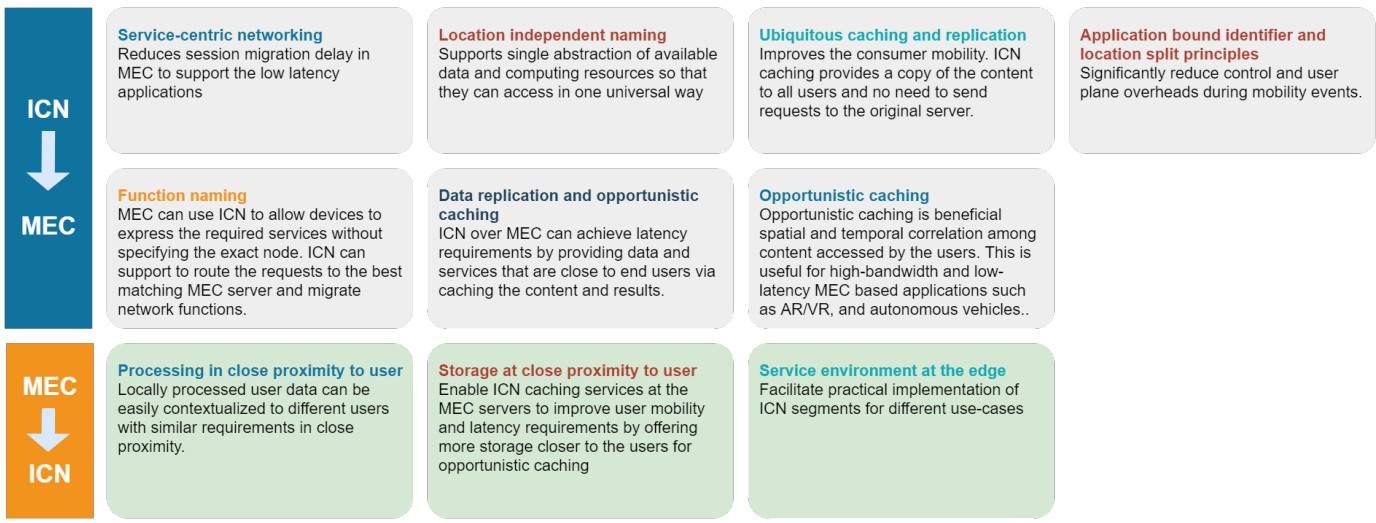

Fig. 4. Mutual Benefits of ICN and MEC integration for specific features of these technologies in Beyond 5G networks.

accompanied by a granular forwarding mechanism is the basic requirement of the ICN-based mobility environments [63]. MEC can facilitate intelligent and sophisticated mechanisms that accompany ICN to function under a latency-optimization objective in such regimes.

6) *Better support for real-time context-aware mobile applications:* Delay-sensitive context aware applications such as autonomous cars and drones can be supported by ICN MEC platforms that provide opportunistic caching schemes at ICN access points. This will trim down unicast transmissions at the downlink considering the provided services and facilitate *contextualized traffic* serving different user requirements. Essentially, contextualized traffic refers to the traffic patterns which can be predicted by analysing the user requests in a vicinity and past traffic activities. Here, the likelihood of using an identical service by a group of users in close proximity can be evaluated, leading to reduction of redundant downlink unicast transmissions, which would otherwise increase the content delivery cost and network level resource (backhaul network resources) consumption for such applications.

Proper re-programming of the ICN layer in the ICN MEC integration may enable user devices to move from one RAN element to another and thus assist transparent mobility among heterogeneous networks [58]. It can be used to tackle link quality fluctuations, which is challenging in the physical and medium-access layer for real-time applications. These link related challenges will be exacerbated with the diversity of radio link technologies in B5G systems.

7) *Content-based security and Privacy:* In ICN MEC integrated platforms, the content-based security offered by ICN will allow authentication during the content consumption. This will eliminate the additional authentication delays. Moreover, the self-certifying (or certificate-less) public key cryptography based naming models of ICN will help to increase security properties without relying on a third party.

Identity privacy is a intrinsic by design in the ICN paradigm rather than the host centric systems [64]. Few privacy attacks are identified ICN such as timing attack, communication

monitoring attack, censorship and anonymity attack, protocol attack, and naming-signature privacy which are generally affecting content, caches and clients. The content anonymity is the most important consideration to preserve privacy in ICN. Therefore, circulating the content as plaintext in the network may improvise more privacy risks. In B5G networks, ICN MEC integrated platforms can be utilized to develop privacy enabling mechanisms (e.g., encryption mechanisms) that provide content and communication anonymity.

8) *Enabler for practical ICN deployments at the edge:* MEC provides a flexible service environment at the edge networks. In that setting, a phased implementation of ICN segments serving different use-cases and thus realizing the benefits of ICN paradigm is possible [65]. This practical aspect is particularly important to exploit benefits of ICN and thus promote its integration in future B5G wireless networks.

The programmable environment in the MEC platforms allow the deployment of ICN software components integrating service elements in an information-centric architecture [59]. For instance, information-centric IoT can be realized by adding caches and ICN routers in the MEC platforms and corresponding ICN clients (adapters) in the IoT devices. This open and flexible deployment and management at the edge alleviates the deployment friction for such a disruptive technology like ICN.

IV. USE CASES OF ICN MEC INTEGRATION FOR REALIZING BEYOND 5G NETWORKS

This section explains how MEC and ICN enabled B5G networks can enable various applications and use cases in near future. Five key use cases are discussed comprehensively while other possible use cases are also briefed with reference to related work available in the literature. Please note that the exact use cases and applications in B5G or 6G networks are still openly and speculatively discussed. Therefore, we put these key use cases under general titles although the specific realizations in B5G or 6G networks are still being elaborated [66]–[69]. For instance, we cover the IoIT Integrated Ultra Smart City-Life [69] under *Smart*

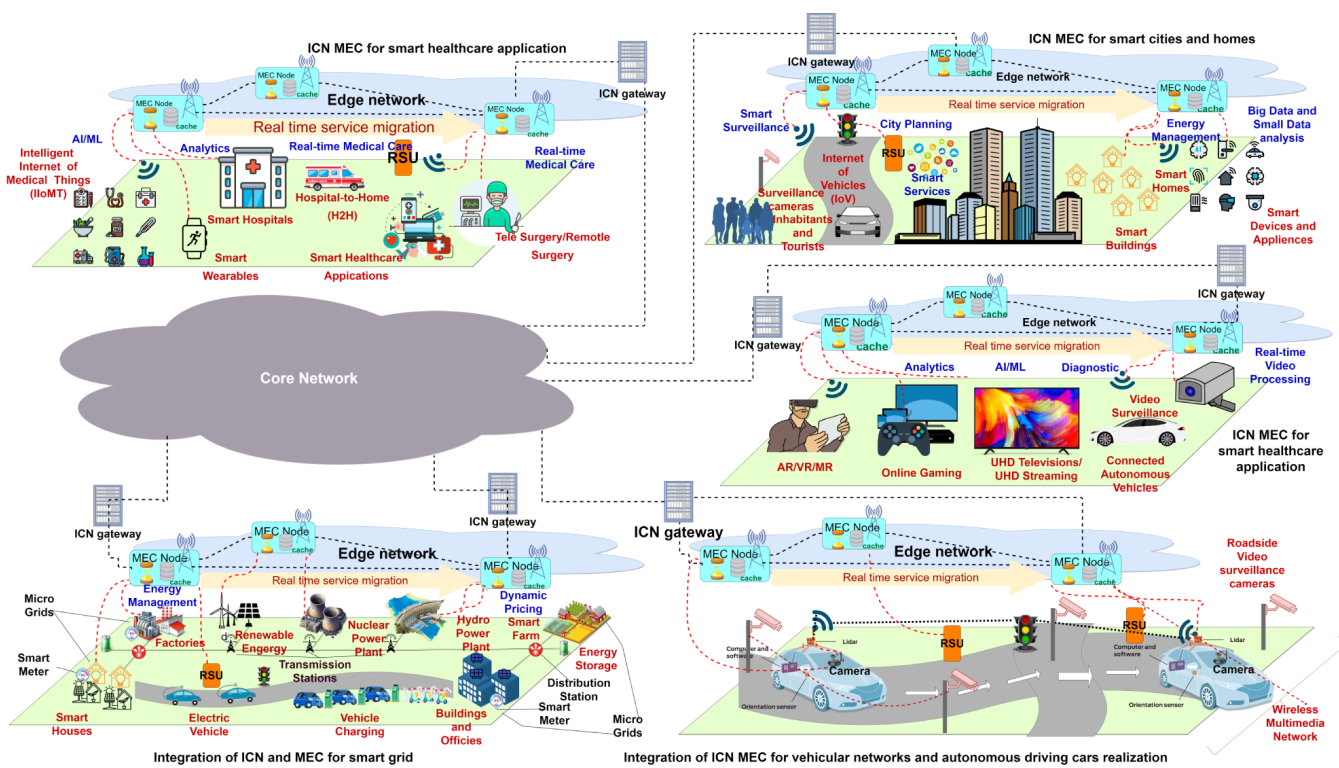

Fig. 5. ICN MEC use cases.

Cities or Multisensory XR Applications [67] under *Networked Multimedia Applications*.

Please note that one option for ICN MEC is to have an information-centric architecture in an end-to-end fashion. The second option is an information-centric MEC environment at the edge to reap benefits of ICN MEC integration with an edge computing focus. Therefore, ICN MEC integration is also instrumental to bring in ICN into future wireless networks in a gradual evolution. Although an end-to-end ICN architecture is ultimately more beneficial, it allows us to reap the benefits with operational challenges and costs.

A. Smart Cities and Homes

Over 70% of the world population is expected to reside in cities by 2050, which would result in heavy urbanization [70]. Moreover, the future population is expected to bank on various digital applications and services as a part of their lifestyle. *Smart Cities* are emerging to facilitate the diverse and complex requirements of future cities utilizing modern information and communication technologies [71]. This will improve and enhance the functionalities of cities while providing sustainable solutions for growing issues such as traffic congestion, pollution, waste disposal and management, and energy and other scarce resource management. Such functions will be possible through the massive deployment of IoT devices and sensors in the path towards the Internet of Everything (IoE).

For instance, only the sensory data capturing tasks, such as, energy monitoring, noise monitoring, and garbage collection in a smart city is expected to generate data in the range of Terrabytes per year [72]. The analysis of *Big Data* gathered

from a smart city provides meaningful insights towards city planning and developments while also providing a deeper understanding about the demands and requirements of its inhabitants [73]. Smart homes are also being matured together with the increase of IoT devices such as home appliances, home automation, and consumer electronics [74]. For instance, smart air conditioners, smart thermostats, smart televisions, smart coffee makers, and smart cleaning robots are gaining demand while being integrated into the lifestyle of human beings [38]. These devices produce a large amount of *Small Data* that needs to be communicated and processed efficiently using Machine Learning (ML) techniques to provide personalized digital services and improve their service quality [67]. MEC facilitates the efficient processing of massive amounts of data generated through heterogeneous IoT devices in Smart Cities to identify meaningful insights [75]. This is due to MEC being located in close proximity to the points where most of the data in Smart Cities is generated. Utilizing MEC enables efficient data processing with minimal delays to facilitate the seamless operation and optimization of smart city functionalities.

The analysis of massive amount of data generated in smart cities can be further strengthened through ICN, which offers features, such as, named-data networking and in-network caching [76]. For instance, retrieving desired data through named-data instead of node addresses is more suitable for efficient data analysis. Furthermore, ICN and MEC can synergistically facilitate smart city applications. For instance, ICN can facilitate high speed sensory data transfers between MEC nodes and cloud processing systems for facilitate efficient data analytics. In addition, dynamic reconfiguration of

smart city applications can be facilitated through ICN through minimizing delays banking on fast-resolution of named-based instances [53]. Moreover, smart city applications such as traffic management and disaster management can be efficiently performed through opportunistic caching schemes in ICN MEC platforms.

1) *Related Work:* [77] discusses how MEC can support smart city services that require high computational power through resource-limited devices. Also, this work elaborates on serious security threats imposed through cloud services offered within the radio network and propose physical layer security technologies to be applied in radio network functions such as signal processing, multi-node cooperation and resource allocation. In addition, a method to utilize an Internet of Vehicles (IoV) based MEC platform to perform computation-intensive and time-sensitive smart city applications, such as real-time computer vision applications for security and public safety, is proposed in [78]. In this work, a task scheduling algorithm is introduced by cooperative utilizing resources in IoVs in smart cities to overcome the limitations of scarce resources in mobile devices. [43] proposes a method to enhance QoS and QoE of video streaming in smart cities to promote tourism. This method moves the video service across MECs based on user movement to allow access to video data with high QoE and low latency regardless of user location. In case of smart homes, [79] proposes a MEC architecture that is combined with network slicing and cloud computing to offer personalized IoT services. In addition, a system that is capable of improving home security and privacy is presented in [80]. This method shrinks attack surfaces of smart homes by means of restricting network access of devices. Furthermore, the large amount of data generated in an IoT network such as a smart home cannot be efficiently transferred and processed using centralized cloud servers, which leads to the requirement of localized MEC infrastructure [38]. Smart cities are in need of having information-centric networks than host-centric networks to cater to growing demands [81]. For instance, a secure publish-subscribe approach that is based on ICN can be used for home energy management [82]. Analytics can be performed on the data collected from such an energy management system to reach insights that would assist towards making better decisions in smart cities in many aspects such as traffic management and urban development. Furthermore, smart services can be offered through integrating sensors, connected vehicles and cloud systems. This can be facilitated through techniques such as named-data networking in vehicular communications systems [76]. Moreover, techniques such as in-network caching can reduce duplicate data transmissions and increase data availability in smart home applications [1]. Furthermore, [1] elaborates on how the integration of ICN and MEC will not only enable faster and efficient caching but also increase security, facilitate data collection, analytics, caching, and multicasting in smart city and smart home applications. Fig. 5 presents an overview of how smart cities and applications benefit from ICN MEC.

2) *Summary:* Prevailing research work elaborates on how to leverage MEC and ICN for smart city and smart home applications. They show that MEC and ICN can be instrumental

in providing better and efficient smart city and smart home applications for B5G networks. However, the integration of MEC and ICN towards improving smart city and smart home applications have seldom been discussed. Research work such as [1] sheds light towards integrating MEC and ICN to provide better services. However, further research is needed to identify and solve ICN MEC integration and practical implementation challenges in smart city and smart home applications for future networks.

B. Networked Multimedia Applications

Networked multimedia applications consist of many applications including video streaming, online gaming, VR/AR/MR applications, and video analytics. The demand for such networked multimedia applications has been growing and is expected to grow exponentially in the coming years. Considering the statistics for 2022 as presented in [15], over 82% of the Internet traffic accounts for video. Moreover, networked gaming traffic is also envisaged to exhibit a significant growth by 2022 to reach 4% of the Internet traffic, which is nine-fold compared to the situation in 2017. Furthermore, VR and AR traffic is also expected to multiply showing an increase of over 12-fold in 2022 compared to 2017. In addition, a significant bandwidth demand is expected around smart gadget and wearable applications related to Ultra High Definition (UHD) VR, UHD televisions, UHD IP video, cloud gaming, Connected Autonomous Vehicle (CAV) control and diagnostics, and UDH streaming [83], [84]. Different networked multimedia applications have diverse network requirements. For instance, UHD streaming requires high network bandwidth while online gaming requires extremely low delays. However, in case of live UHD video conferencing applications, latency should also be minimal. Specifically, VR/AR/MR applications require high data rates beyond 20 Gbps and round-trip over-the-air latency beneath 1 ms with high network reliability and availability [38]. On the other hand, multimedia IoT systems require efficient communication of captured footage to servers to perform video analytics for behavior analysis and event detection [85]. These demands should be catered by B5G networks. MEC is instrumental in providing multimedia services such as streaming, AR, VR, and MR across B5G networks. This is due to the improvements made by MEC in terms of improving the network bandwidth, latency, and the usage of contextual information.

The features of ICN, such as named-content and in-network caching are instrumental in enhancing the performance of networked multimedia applications including ultra-high definition video streaming and interactive gaming [86]. In this regard, ICN can enhance the capabilities of MEC to facilitate the demanding requirements of future networked multimedia applications. For instance, ICN enables efficient content delivery between cloud based content providers and MEC nodes to facilitate interactive gaming applications. Such networked multimedia applications can be further strengthened through efficient storage and caching at the MEC nodes, banking on key ICN features such as independent naming and opportunistic caching. Furthermore, the usage of ICN can enhance

session mobility in MEC networks, which will reduce the network load and improve the QoS in multimedia applications.

1) *Related Work:* [87] proposes an edge computing framework enabling cooperative processing banking on unutilized resources in mobile devices to facilitate delay-sensitive multimedia IoT tasks. Further, [88] proposes a method to decide the number of MEC Points of Presence (PoPs) and the locations where the PoPs should be deployed. Thus, the strict latency requirements of URLLC can be facilitated in B5G networks to enable low-latency streaming services. Furthermore, an architecture and a hardware/software co-design to implement edge computing for Internet of Media Things (IoMT) applications is presented in [89]. This MEC system is capable of efficiently compressing and encrypting multiple images simultaneously. Another method to perform IoT assisted caching multimedia in ICN to enhance user experience is presented in [90]. This method banks on location prediction and smart caching based on ML to predict the interest of users. Furthermore, collaborative integration of in-network caching together with edge computing to transmit multimedia content over 5G networks with guaranteed QoS was discussed in [91]. The authors propose a hierarchical-caching-based content-centric network architecture. The proposed hierarchical edge caching mechanisms incorporates random hierarchical caching, game-theory-based hierarchical caching, and proactive hierarchical caching. In addition, [92] provides a method to allocate resources for ICN using in-network caching and MEC. In this work, an information-centric heterogeneous network framework was proposed to facilitate content caching and computing. Due to the virtualization of this system, the available caching, communication, and computing resources can also be shared among users. Moreover, [93] also proposes a method to minimize delay and energy consumption in network connectivity and resource allocation for caching in ICN with MEC.

2) *Summary:* Existing research work identifies multimedia communication as one of the key applications of MEC and ICN. Thus, MEC and ICN are considered as enabling technologies for demanding networked multimedia applications in B5G networks. The integration of MEC and ICN provides many improvements for multimedia communication as illustrated in Fig. 5. However, the envisaged multimedia applications such as multisensory XR networks complicate this aspect. Further research work is required to solve MEC and ICN integration challenges of networked multimedia communication for practical implementation in B5G networks.

C. Vehicular Networks and Autonomous Driving Cars

Due to the growing popularity of autonomous driving cars, the fully and semi-autonomous driving cars and their related services are important technologies to be supported by 5G and Beyond networks [94]. These cars are equipped with advanced sensory units and frequently communicate with the road side units to obtain a detailed preview of the road ahead. These advanced sensory units are ranging from cameras, GPS, radar, sonar as well as LIDAR (Light Detection and Ranging) [95], [96]. Such communication allows the cars to enable

new features and functions such as adaptive cruise, predictive power-train control and adaptive navigation. However, a future autonomous cars is expected to utilize up to 4 TB data per day [97]. Thus, each car will consume about as much data as used by almost 3,000 people [33]. Moreover, digital horizon around the vehicle is significantly increasing. Lots of riders are now interested in accessing cloud based services such as HD video streaming and use various latency-sensitive mobile applications such as real-time online gaming and virtual sports. Most of these connected applications require tactile speed with latency approaching 1 ms [98]. In this case MEC plays a vital role of satisfying this requirement by bringing computational resources, storage and services closer to users. In addition, it can enable the context awareness due to the close proximity processing of data. However, current MEC implementations are facing data dissemination challenges when used in highly dynamic networks such as autonomous car ecosystems. Especially, current host-centric networking model used in MEC is not adequate to provide services to highly mobile users and nodes which are constantly hop-on and hop-off from the network in that environment [33].

In this context, ICN can enhance the capability of MEC. For instance, ICN based producer mobility schemes can be used in ICN MEC systems to support high speed mobility events. Both anchor based and anchor-less approaches can be utilized [99]. This enables the high speed migration of control functions as well as other services to the MEC end hosts along the path of a car. This scenario can be further extended to enable the proactive content and result placement. With the help of ICN, it is possible to pre-fetch the popular common data such as local maps or weather information and store it within ICN caches to reduce the end-to-end latency. Many ICN based predictive and proactive caching/fetching strategies for computation results are promising to use in MEC systems in B5G setting [33]. Fig. 5 illustrates the use of ICN MEC integration for vehicular networks and autonomous driving cars realization.

1) *Related Work:* In [100], authors consider application of connected vehicle scenario where the vehicle's navigation system utilizes the data from the MEC based traffic monitoring service. They discuss the deployment option of ICN based MEC for this use case and compared the added benefits over IP based MEC. They also claim that ICN based MEC can offer benefits such as opportunistic caching and storage, content-based security, easily contextualization of data to different user requirements and better mobility handling than IP based MEC deployments [100]. Moreover, a survey on challenges and opportunities of information-centric MEC for connected vehicle environments is presented in [33]. As highlighted in the paper, various information-centric MEC integration challenges related to security, privacy, orchestration, routing, caching and data dissemination are to be addressed for proper utilization of ICN MEC in connected vehicle environments.

In [101], authors present an integrate architecture of fog computing with ICN for IoV in smart cities. The proposed Fog-ICN integrated architecture can offer advanced mobility support by utilizing different schema which consider the data characteristics such as user-shareable data and com-

munication data. Moreover, fog capabilities such as close proximity computation, storage and location-aware and ICN features to design an efficient mobility support mechanism eliminate the resource consuming FIB update process during frequent mobility events. The integration of NFV and ICN for Advanced Driver-Assistance Systems (ADASs) is presented in [102]. The use of MEC along with NFV will enable many NFV-ICN based ADAS applications. For instance, AR offers many location-based content services for in-vehicle consumers in many ADASs where MEC plays a important role in deployment of AR services on vehicular and B5G networks. Moreover, the importance of ICN MEC integration for intelligent resource allocation management for vehicles networks is discussed in [103]. MEC can be used to improve the mobility, flexibility and security of green information-centric networking in smart cities. An integrated framework for connected vehicle is proposed in [104] by integrating features of SDN, NFV, MEC and ICN technologies. The proposed framework enables dynamic orchestration of networking, caching, and computing resources to improve the performance of next generation connected vehicular networks [104]. Authors analyze the resource allocation strategy in that architecture as a joint optimization problem by considering networking, caching and computing resources.

2) *Summary*: The existing research work theoretically analyzes the potential benefits of ICN MEC integration for vehicular networks and autonomous driving cars scenario. However, existing work still lacks a comprehensive framework for proper integration of ICN and MEC for connected vehicle scenario in B5G networks. Also, current research works are lacking of practical implementation or proper test bed level validation and deployment of proposed solutions. Existing related works was able to highlight the potential ICN MEC integration challenges related to security, privacy, orchestration, routing, caching and data dissemination in the context of connected vehicle scenario. However, finding the possible solutions for most of these challenges is still open for future networks.

D. Smart Healthcare

Smart healthcare is envisaged to become an important application in B5G networks to revolutionize the healthcare sector, especially by the usage of large number of IoT sensors, cyber-physical medical systems, and analytics through Artificial Intelligence (AI) and ML [105]. This requires meeting strict network requirements ranging from high reliability to low latency [3]. Also, Intelligent Internet of Medical Things (IIoMT) is expected to develop, weaving a network of connected equipment, devices and people related to providing healthcare facilities [106]. Further, physical hospital visits can be minimized using virtual presence while Hospital-to-Home (H2H) services are developing towards bringing hospital resources to people to facilitate health services conveniently [105], [107]. In addition, tele-surgery, remote-surgery, and collaborative-surgery applications are evolving to increase the availability of talented surgeons to attend to complicated surgeries regardless of their physical location [108]. However, these services require demanding network conditions such

as ultra-low latency, reliable communication and access to powerful computational resources in near real-time. Satisfying the communication requirements of advanced smart healthcare applications envisaged in B5G networks can harness MEC capabilities in B5G networks [109], [110]. This is through MEC features, such as, in-network processing and accurate localization.

ICN can also facilitate smart healthcare applications in the B5G era. For instance, ICN can enable efficient communication between medical devices that interact with various sensors, either in-body or in wearables, and medical centers [81]. Accordingly, ICN can enable direct access to content, which reduces system overheads to increase the efficiency of data transmissions. Furthermore, ICN enhances user mobility functionality of networks to assist mobile patients and Hospital-to-Home applications. The enhanced data security offered through ICN is also instrumental for health care applications to ensure user privacy. The usability of ICNs with MEC also extends towards smart healthcare applications. MEC enabled context-aware data distribution in healthcare applications, such as remote patient monitoring, can be further improved banking on ICN to allow efficient content distribution over unreliable networks. Furthermore, low latency applications, such as remote surgery and ambient assisted living can bank on fast and efficient content migration between ICN and MEC enabled central cloud systems. In addition, heterogeneous and dynamic healthcare applications, including hospital-to-home patient care, can be performed in a cost efficient manner owing to enhanced session mobility of ICN MEC networks.

1) *Related Work*: [111] elaborates how MEC capabilities such as in-network and context-aware processing enables the efficient handling of large amounts of data gathered through massive numbers of IoMT devices at the edge of the network. This enables efficient data delivery by supporting various features such as edge-based feature extraction for event detection and multi-modal data compression. Also, the energy efficient operation of many functions including event detection and video and image compression is facilitated. In addition, applying localization techniques considering context information also allows patients to obtain necessary healthcare facilities from the closest hospitals or ambulances as required. Furthermore, user privacy is also improved by utilizing MEC to process data at the edge of the network. Due to close proximity, MEC is also capable of providing the functionality of a local IoT gateway to aggregate and process data for reporting events such as health hazards in e-health systems [30]. However, processing *Big Data* in MEC requires offloading computational tasks from data centers towards the edge of the network. One concern in this regard is that the possibility of an attack is high due to the lack of centralized management of edge nodes, leading to privacy concerns. [112] proposes a secure architecture for MEC that addresses privacy concerns, especially in data aggregation and mining in *Big Data* applications using MEC. These MEC functionalities can be strengthened through the utilization of ICNs, which is also enabler of smart healthcare applications in the B5G era [81]. However, ICN can also introduce a number of security issues to smart healthcare applications. For instance, ensuring the security of

sensitive health data in an ICN where data is cached in a distributed fashion is a challenge. This is due to the fact that the publisher has no control of the data once it is published. [113] proposes a resource efficient and secure data sharing approach for ICN based smart healthcare applications using ciphertext-policy attribute based encryption. Furthermore, the paper investigates on how to utilize computational resources of fog nodes to increase the efficiency of cryptography, especially in case of medical devices with limited computational resources. However, considering [114], the integration of MEC with ICNs can facilitate tactile internet capabilities for delay-sensitive applications such as remote patient monitoring and remote surgeries. Furthermore, by means of bringing content and resources closer to the user, ICNs can facilitate real-time communication for robots in smart healthcare systems. Also, pervasive AR and VR healthcare applications can be enabled through integrating MEC with ICNs in B5G networks.

2) *Summary:* Smart healthcare applications in B5G networks can benefit from both MEC and ICNs. MEC supports efficient and secure communication and processing of data in smart healthcare applications by processing data at the edge of the network. On the other hand, ICN further improves the efficient and secure communication of data in smart healthcare applications using MEC. Evidently, the integration of MEC with ICN enhances the capabilities of B5G networks to facilitate emerging smart healthcare applications, as presented in Fig. 5. However, the integration of MEC with ICN is only discussed as a possible solution for smart healthcare applications. Thus, the research community needs to concentrate on how to realize MEC with ICN by means of solving the inherent integration challenges.

E. Smart Grid

Smart grid integrates advanced sensing, communications, and control in the generation, transportation, distribution, and consumption of electricity [115], [116]. In a smart grid, grid data are collected by means of smart meters, then necessary information is extracted and exploited to improve the efficiency, reliability, and safety. Based on grid data, the providers establish dynamic pricing policies. Furthermore, a subgroup of customers can form a micro-grid with self-generating and management mechanisms.

In smart grids, the information processing in the providers and customers can rely on cloud servers [117]. However, a cloud-centric design poses some major challenges and issues, such as the delay due to the communication between the distant cloud servers and the providers/customers, network failure caused by a large communication load, and the leakage of sensitive/private information regarding daily activities of the customers [118], [119]. By executing the data processing tasks at the edge of the grid, MEC alleviates these issues. Various computation tasks in smart grids can be executed in MEC servers, such as resource provisioning, dynamic and real-time pricing, and price-following demand management [120]. The execution of these tasks relies on grid data collected at the network edge, thus can benefit from data management solutions provided by ICN. Moreover, the MEC structure

facilitates self-management functionalities in micro-grids, e.g., the execution of energy transactions. Complementarily, for the energy transactions, energy users can submit their requests in terms of interest packets, which can be supported via CCN. MEC also fits in the geo-distributed nature of the grid components such as power generators and energy transformers [121], and the mobility of electric vehicles [122]. To this end, a distributed data market can be established based on ICN [123], which is beneficial especially for connected vehicles [33].

ICN is a favorable match for the communication requirements in smart grids [124]. It simplifies the establishment and reconfiguration of communication flows, as well as enables in-network management of smart grid data. The electric devices naturally communicate in a group-oriented publish-subscribe fashion, which naturally maps to the ICN's "interest content" model. This publish-subscribe mechanism allows new entities to seamlessly enter the energy market and thus enhances the scalability of the system. In addition, ICN introduces new functionalities into smart grids, such as the caching of energy consumption measurement data. With the computational capability of the MEC servers, these new functionalities can be executed at the network edge. Furthermore, ICN enables the devices to access data without revealing where the data location, thus enhances security. This complements the security enhancement enabled by MEC. Fig. 5 depicts the use of ICN MEC integration for smart grid.

1) *Related Works:* The system architecture for MEC-based smart grids have been proposed in, e.g., [121], [125]–[127]. In [121], a three-tier architecture was proposed for MEC-based smart grid, composing of smart meters, MEC servers, and cloud servers. Another architecture proposed in [125] comprises five layers, namely, IoT device layer, edge network layer, edge server layer, internet layer, and cloud layer. In the architecture proposed in [126], the MEC servers are located in the cellular base stations and leverage wireless cellular network to communicate with smart meters. In these architectures, MEC does not replace cloud computing but is rather deployed alongside to extend the capabilities of cloud-based smart grids. In [127], a MEC model for information processing in smart grid was proposed, where a MEC server is responsible for a micro-grid composing of several smart homes. In [122], the authors investigate the use of MEC in vehicular delay-tolerant networks for data dissemination to various devices in the smart grid. MEC was also shown to enable advanced distributed state estimation methods for smart grids [128]. In electric vehicle charging systems, mobility-aware MEC servers can be deployed to disseminate service providers' predicted charging availability and collect vehicles' charging reservation, thus reduce the communication and computational cost [129].

To support home energy management, ICN was used to design a secure publish-subscribe system in [82]. To enforce security in ICN-based smart grids, cryptographic solutions were proposed in [130], [131]. In [124], ICN was utilized to enable machine-to-machine communication in smart grids for wide area monitoring. Besides, ICN can substantially enhance the quality, and reduce communication and security complexity of smart charging of electric vehicles [132]. The benefits of ICN for smart grids have been showcased in both

laboratory setup and real field trial in a live electricity grid in Netherlands [133]. An information-centric advanced metering infrastructure for measuring, collecting, storing, analyzing, and exploiting energy usage data in smart grids was presented in [134]. The paper [135] proposed a three-level architecture for information-centric smart grid (iCenS) that is scalable and meets the communication requirements. The traffic and service capacity of iCenS was then modeled in [136]. This allows to predict the quality of services (QoS), which is used to design an energy efficient routing scheme.

2) *Summary*: Both MEC and ICN are suitable for the computation and communication requirements in smart grids. A large number of architecture designs have been proposed separately for MEC-based and ICN-based smart grids. However, the joint design of MEC and ICN in smart grids has not been investigated to its full potential. The distributed processing feature of MEC and spatiotemporal decoupling provided by ICN can complement well in enhancing the security and privacy of the grid in future networks. A highly relevant use case that showcases the mutual benefit of MEC and ICN is the electric vehicle charging problem, where the two technologies support interaction between service providers and vehicles while the latter is on the move. Integrating multi-functional MEC and ICN into smart grids also leads to energy-efficient information and communication infrastructures, since the power consumption of the servers can be satisfied by renewable energy generated in the grid [116]. These are crucial capabilities to serve smart grid scenarios in B5G systems.

F. Other Possible Use Cases

In addition to the use cases that are comprehensively discussed in this section, some other possible use cases of MEC and ICN utilizing B5G networks are summarized below.

1) *Smart Agriculture*: Smart agriculture integrates several information and communication technologies to increase productivity in the agriculture sector. MEC provides effective means for farmers to access and utilize smart agriculture services through data analysis, edge mining, computation offloading, reducing latency and traffic, and distributed data collection, as presented in [137]. An example is farm automation where a closed ecosystem relies on edge servers to process the collected data and make local decisions without relying on remote cloud. Furthermore, ICN enhances content caching while decoupling the sender and the receiver to provide smart agriculture services efficiently [138]. Furthermore, ICN can enable seamless communication for devices that are asynchronous and only switches on demand, based on user interest or device requirements [139]. This aids the data collection and processing, e.g., in the aforementioned farm automation example. Thus, the integration of ICN and MEC will be able to facilitate both the real-time and resource intensive data analytics while supporting low-power IoT devices in smart agriculture applications. However, the integration of MEC and ICN towards realizing smart agriculture applications require more research work to realize diverse smart agriculture applications in the B5G era.

2) *Retail*: Retail market applications include smart payment, supply chain management, digital signage, digital marketing, smart shelves and vending machines, autonomous delivery using CAVs and drones, and data analytics. On-site MEC servers can facilitate these services while also providing high speed mobile coverage to users within store areas [38]. A prospect scenario in retail is walk-out checkout, where the purchases are tracked automatically and thus the shoppers can simply choose their items and leave without having to queue for paying. This can be enabled by real-time video analytic and sensor data processing aided by both MEC and ICN. ICN further enhances the functionality of MEC in retail by efficient content caching and delivery through adding identifiers for various information items such as price, and promotional videos [140]. Together with more research and development work, MEC and ICN are envisaged to play an important role to enhance retail services across B5G networks.

3) *Industrial Internet*: Industrial Internet, specifically the development of Industrial Internet of Things (IIoT) and Industry 5.0, focuses on human-machine interactions, factory automation, process automation, equipment monitoring and maintenance, and logistic arrangements. MEC is capable of improving the performance of IIoT systems by minimizing latency, increasing resilience, increasing efficiency by better resource management and offloading [3]. For example, MEC helps to automate maintenance procedures of IIoT devices by analysing status updates from these devices and executing predicting methods. Furthermore, the data-centric nature of ICN supports data processing at the network layer to perform functions such as in-network data processing and optimization of data traffic routes to facilitate IIoT applications [141]. Hence, the integration of MEC and ICN has the potential to facilitate more efficient in-network data processing and data communication among IIoT devices to streamline the operations in the envisaged Industrial Internet applications.

4) *Tactile Internet*: Tactile Internet features ultra-low latency together with extreme levels of reliability, availability and security to facilitate future Internet applications [3]. Potential use cases in tactile internet include bidirectional haptic communications between a human operator and a teleoperator robot, for which MEC facilitates the control loops on both ends, while ICN helps to establish a reliable communication network in between. MEC is able to facilitate computing resources at the edge of the network to facilitate low-latency communication and processing required for Tactile Internet. In addition, ICN features, such as edge caching and efficient routing, can enhance MEC capabilities to provide near-real time information processing and communication, which is integral towards realizing Tactile Internet applications in B5G mobile networks [142].

V. INTEGRATION CHALLENGES OF ICN AND MEC

Various integration challenges that need attention to seamlessly integrate ICN and MEC for B5G networks are discussed in this section.

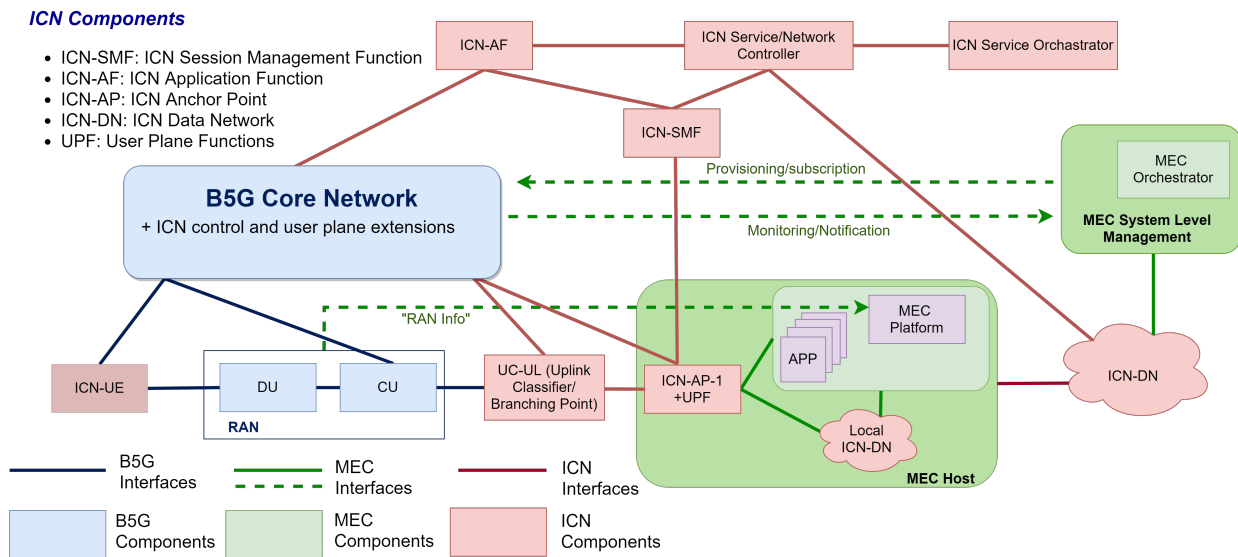

Fig. 6. Architectural integration of MEC and ICN in 5G and beyond networks [1], [100], [143].

A. Deployment and Orchestration

Despite being complementary concepts, independent deployment of ICN and MEC technologies can be seen in many current telecommunication and other networking systems [144]. For instance, Sami *et al.* [145] have proposed 5G-MEC integration, whereas, Ravindran *et al.* [100] have presented 5G-ICN integration approach. However, simultaneous integration of MEC and ICN in B5G networks still lacks adequate attention. Thus, it is necessary to explore the possible integrated ICN MEC architectures for 5G and beyond networks. To realize this goal, several steps needed to be taken. First, it is necessary to define appropriate Application Programming Interfaces (APIs) to establish proper communication between the different ICN and MEC components in the core and backhaul segments of B5G networks. Second, a system level orchestrator and/or coordinator entity should be added as a VNF to support the management and cooperation of these devices. Third, the integrated ICN-MEC architecture should be able to provide automatic and autonomic system control rather than the legacy manual provisioning, configuration and network control.

Possible Solutions: To realize the goal of joint deployment, a possible integrated ICN MEC architecture for 5G is presented in Fig. 6 based on [100]. In 5G core network, four NFs (i.e., Policy Control Function (PCF), Access and Mobility Management Function (AMF), Session Management Function (SMF) and Unified Data Management (UDM)) have to interface with ICN components. SMF manages UE's ICN sessions. ICN-UE should also be subscribed and imposed using the PCF and UDM for policy and session management of ICN sessions. Additionally, it should support ICN and ICN applications. UEs have to be authorized to access ICN DNs. Therefore, ICN UEs have to establish a connection with AMF. To support low latency applications, some of the ICN components such as ICN-AP, Local ICN-DN should be implemented in MEC hosts.

B. Context Awareness

In order to harness maximum potential of MEC-enabled services, context related information, such as, user's current location, resource availability, and other relevant ambient information are required. ICN can furnish the required contextual information at various levels, including, application level, network level, interface, and content level. However, inefficient utilization of such information results in suboptimal decisions in forwarding plane [146]. Furthermore, improving the quality of one of the services may lead to degradation of QoS for other coexisting services [147]. As mentioned by Posch *et al.* [146], context information is currently being used for meeting out basic functionalities instead of using it for enhancing network parameters like QoS and QoE.

Possible Solutions: For the profitable integration of ICN and MEC, efforts are required on the ICN side to provide more context information that can serve as input to MEC systems. At the same time, MEC should be able to efficiently utilize that context information from ICN. Many new MEC-based services (e.g., Real-Time Location Systems (RTLS), Anonymous Video Analytics (AVA), and AR) can improve the context awareness in ICN MEC integrated B5G systems. RTLS (aka real time tracking system) is a form of wireless system that identifies and tracks the real-time location of people or objects within a confined area and do not rely on global positioning system [148]. AVA is a technology that anonymously gathers information by scanning the area under the vision of camera sensors. Based on the gathered information, the aim is to detect the patterns to reveal information such as gender and age [149]. In particular, AVA does not record images or video feeds but logs extracted pattern-based data. Unlike facial recognition technology, it does not match images against a database but uses pattern detection algorithms.

C. Security

From the security viewpoint, Denial of Service (DoS) [150], Content Poisoning Attacks (CPA) [151], [152] and

TABLE III
CHALLENGES AND RESEARCH DIRECTIONS FOR ICN AND MEC INTEGRATION IN 5G AND BEYOND EDGE.

| Challenge | Importance | Possible Solutions |
|------------------------------|---|---|
| Deployment and Orchestration | Synergistic deployment architecture defining the nexus between MEC and ICN is required for B5G | To define common use cases, clean APIs and reference points in B5G specifications |
| Context awareness | ICN to provide the available context information (users, applications, services, resources, and environment) to MEC to enhance QoS and network performance for B5G use cases | MEC can enable context-aware localized services and ICN can support MEC providing proactive caching. ML techniques for situational awareness |
| Security | Threats and vulnerabilities of both ICN and MEC need to be considered together for overall security. Also, traditional access control techniques seem infeasible for ICN. | ML techniques for threat detection, MEC driven ICN traffic isolation, AI driven security management, user-level authorization and access control mechanisms |
| Privacy | ICN inherent features such as named content and in-network caching can be targeted by attacker to retrieve private information related to user and/or data. | Use of lightweight encryption techniques at device and cache nodes, use of blockchain-assisted mechanism to preserve privacy, privacy-protected data aggregation. |
| Naming | Which naming structure to be used - Hierarchical variable-length names may be appealing for network and context-based operations, however, might not be suitable for massive IoT in B5G. | Scalable and manageable naming structure selection, redundancy minimization, versioning, hybrid naming scheme. integration of service name with content name. |
| Mobility | Mobility support from different perspectives are important - consumer, producer and application mobility. With the expected 3D mobility in B5G networks it becomes even more challenging. | Mobility as a service, intelligent mobility models with movement patterns, tight coupling of mobility management with network management. |
| Network slicing | E2E slice management and orchestration need to take into account both ICN and MEC entities jointly to harness full benefits. | Designing of slice manager that communicates with elements of ICN and MEC, ICN-based service slice that can optimize the working of MEC network. |

cache pollution [153] are some of the key security related threats to ICN. This calls for careful instillation of security measures in ICN MEC systems. By the virtue of in-network caching ICN facilitates on-demand and opportunistic delivery of Named Data Objects (NDOs), thus use of traditional access control techniques based on Access Control Lists (ACLs) is challenging in ICN [154]. In particular, such approaches are difficult to realize due to privacy issues and computational overhead.

Possible Solutions: Some of the emerging (homomorphic) encryption-based, attribute-based [155], session-based, and proxy re-encryption-based [64] access control techniques can be investigated for ensuring end-to-end security for B5G ICN-MEC integrated scenarios. Another practical approach for secure co-existence of ICN and MEC in B5G networks would be to deploy a dedicated network slice with enhanced security provisioning to isolate MEC-driven ICN traffic. Nevertheless, since authorization and access control challenges are intrinsic to ICN-based systems, the network slicing based solution is non-trivial for ICN MEC integrated systems. Moreover, since user-to-server authentication is challenging for named contents (cached at network nodes) in ICN, security at content-level with proper confidentiality and credentialing is required.

D. Privacy

In ICN, privacy issues are discussed in terms of name and signature privacy, user privacy and anonymity, and content privacy [64]. Although it is guaranteed that the content is protected and the dissemination of information is controlled, there can be instances where user or data privacy can be compromised [156]. Malicious parties may exploit the information transferred through wireless medium to find the identities and other relevant information of users. Especially in ICN, the

name of the content is typically sent as plain text or as self-certified text. Therefore, this will open new possibilities for attackers to reveal the content and the size and the frequency of content requests.

Possible Solutions: In order to mitigate the privacy issues that may arise with revealed content names, encryption mechanisms can be introduced at the devices and even at the caching points in the ICN MEC converged networks [157]. However, this will add a reasonable overhead to the processing of every single hop. Although pseudo names can be added with the privacy sensitive requests, they may also restrict the readability of the naming schemes. Therefore, this type of pseudonymous authentication in ICN MEC realization should be carefully investigated in future networks. Blockchain is another emerging technology that can be incorporated with ICN MEC privacy preservation solutions [158].

E. Naming

Named content is one of the core innovative offerings of ICN, however, there are few challenges that comes up when one talks about integration of ICN and MEC. In view of different proposals for namespace like hierarchically structured versus flat names [159] or hybrid naming [160], it becomes challenging which name structure to use, particularly for the estimated proliferation of IoT devices in B5G use cases. In general, IoT devices are resource constrained so they transmit small data for short duration. Hence, using long and variable-length names might be challenging for IoT-enabled applications since the data turns out to be smaller than the name itself [161].

Possible Solutions: Some of the possible approaches to overcome the naming related challenge are hybrid naming, hash-based naming, versioning, contextual and semantic-based naming. Hybrid naming scheme can be a viable solution

for massive IoT. For instance, Arshad *et al.* [162] proposed a hierarchical naming scheme for smart campus IoT. This scheme has three different components, namely, *hierarchical component*, *attributes component*, and *flat component*. Naming devices can be useful in an IoT system to access a particular device. Also, hash-based names (i.e., flat names) can be integrated with hierarchical naming to harness the best features of these two naming styles [163]. Furthermore, versioning can be used for named content, which are cached throughout the network and has tendency to undergo frequent updates. In addition, contextual hierarchical names can be used to facilitate communication with smart devices in an ambient environment. Moreover, semantic-based names facilitate keywords-based retrieval of the named contents. Integration of the service name with content name is another interesting solution to specify the service required to tackle the named-content. For instance, Amadeo *et al.* [164] suggested the use of service tag that can be appended to the content name with a demarcating field.

F. Mobility

The core features of ICN including named content, in-network caching and data-level security, allow users to retrieve and consume a desired content from any second source (ICN-enabled node) irrespective to the end-points (i.e., original server hosting a content). Thus, the support for mobility and session-less transport is intrinsic to ICN. This implies that when a mobile consumer detaches and connects to a new point of attachment then this gets easily handled by pull-based communication and one-to-one coupling of interest and data packets. Therefore, consumer mobility is well supported by ICN, but producer mobility and network mobility in B5G edge services are important mobility issues yet to be addressed. Producer mobility allows the producer or the provider of the content to be mobile. If not dealt properly, producer mobility may lead to interest packet re-routing overheads and uncertain delays [165]. Network mobility as defined in [166] deals with the mobility of network segment or domain. Furthermore, from a different perspective, synchronization and handover of mobile nodes between different segments of edge networks with and without ICN capabilities is also challenging.

Possible Solutions: An interesting solution to mitigate mobility challenge in ICN MEC integrated system is to roll-out mobility as a service. Such a service can be leveraged when there is a suitable condition or when a user or content needs it. Another solution would be the formal mobility modeling in context of ICN, however, this calls for careful analytical investigation of not just the consumer mobility but also of producer's movement pattern [167]. Furthermore, the synergy between mobility management and network management can be explored to promise seamless mobility in B5G networks.

G. Network Slicing

Network slicing allows the creation of multiple virtual networks on top of a common shared physical infrastructure [168]. Thus, it will play an important role to enable different 5G traffic classes as well as future B5G service types running over a common underlying infrastructure [169]. Therefore,

it is also important to implement the network slicing along with ICN and MEC to realize the full benefits of integration. However, E2E network slice management, orchestration and automatic slice provisioning is not trivial as slice management entities have to be coordinated not only with MEC but also with ICN management entities such as ICN service orchestrator and ICN network controller.

Possible Solutions: From the operational perspective, a separate network slice provides a unique deployment opportunity for ICN with MEC for different applications. For instance, a use case of ICN based service slice for the IoT edge network is presented in [170] to improve utilization of available compute resources in IoT devices. It is worthwhile to investigate other possible B5G use cases where network slicing can be used to improve the performance of ICN MEC systems.

VI. STANDARDIZATION

Both MEC and ICN have a very broad and active standardization landscape. There has been a sizeable set of global standardization bodies (Standards Developing Organization - SDO) that are contributing immensely to MEC and ICN. In the following, we focus on four main SDOs, namely, ETSI, IETF, ITU, and 3GPP, as shown in Table IV. We compile and analyze their efforts from a forward-looking perspective considering their relevance for future developments of B5G networks.

1) *European Telecommunications Standards Institute (ETSI):* As the main responsible SDO for MEC, ETSI established the MEC ISG [40] in 2014 to standardize the MEC concept and specify the MEC operation. Since then, this group has been actively developing regular normative specifications, informative reports, and white papers on different aspects of MEC. These include a package of APIs that specify general design principles to ensure common practices and interoperability in the interface of MEC applications and operator system. These design principles include radio network information [185], location services [186], user identity [187], traffic management [188], mobility support [189], and MEC in WLAN [190] and vehicle-to-everything (V2X) networks [191]. Specification [2] provides a framework and reference architecture for MEC that enables efficient and seamless run of MEC applications in a multi-access network. Group Report [171] presents key issues and proposes solutions to integrate MEC into 3GPP 5G system. The MEC functionalities to support network slicing are identified in Group Report [172]. In general, ETSI ISG's publications not only address the technical aspects and the integration of MEC into global communication systems, but also promote innovation and accelerate development of third-party applications.

ETSI ISG also investigates ICN in the Next Generation Protocols (NGP) and Non-IP Networking (NIN) groups. In particular, the first group specification of the NGP group [192] defines scenarios related to ICN and CDN.

¹We consider the latest update date of the document stated in the SDO repositories. There may be more recent in-progress yet unpublished versions due to ongoing SDO work group efforts.

TABLE IV
RECENT IMPORTANT STANDARDIZATION EFFORTS FOR MEC AND ICN.

| SDO and work group | Standards document/Specification/Publication | Topics | Update/publication date ¹ |
|--------------------|---|---|--------------------------------------|
| ETSI MEC | [GS] ETSI GS MEC 003 V2.2.1 Framework and Reference Architecture [2] | MEC reference architecture | 2020-12 |
| ETSI MEC | Group Report [GR] ETSI GR MEC 031 V2.1.1 MEC 5G Integration [171] | MEC integration into 3GPP 5G system | 2020-10 |
| ETSI MEC | [GR] ETSI GR MEC 024 V2.1.1 Support for network slicing [172] | MEC functionalities to support network slicing | 2019-11 |
| IETF ICNRG | Internet-Drafts [I-D] ICN Adaptation to LoWPAN Networks (ICN LoWPAN) [173] | A convergence layer for CCNx and NDN over IEEE 802.15.4 LoWPAN networks | 2021-02 |
| IETF ICNRG | [I-D] Architectural Considerations of ICN using Name Resolution Service [174] | Naming and name resolution | 2021-02 |
| IETF ICNRG | [I-D] Enabling ICN in 3GPP's 5G NextGen Core Architecture [175] | ICN for 5G core networks | 2021-01 |
| IETF ICNRG | [I-D] CCNinfo: Discovering Content and Network Information in Content-Centric Networks [176] | "CCNinfo" mechanism for discovery of network topology and in-network cache in CCN | 2020-09 |
| IETF ICNRG | [I-D] Considerations in the development of a QoS Architecture for CCNx-like ICN protocols [177] | Accommodating QoS capabilities in ICN protocols | 2020-11 |
| IETF ICNRG | [I-D] Design Considerations for Name Resolution Service in ICN [178] | Naming and name resolution in ICN | 2020-10 |
| IETF ICNRG | Request for Comments [RFC] Deployment Considerations for Information-Centric Networking (ICN) [179] | ICN deployment | 2020-06 |
| IETF ICNRG | [RFC] Information-Centric Networking: Baseline Scenarios [180] | ICN scenarios | 2015-03 |
| ITU-T SG 13 | Y.3076 Architecture of Architecture of ICN-enabled Edge Network in IMT-2020 [181] | ICN and MEC integration architecture | 2020-09 |
| ITU-T SG 13 | Draft Recommendation [DR] Y.ICN-core-arch Requirements and architecture of information centric core network [182] | Core network architecture for ICN | 2019-10 |
| ITU-T SG 13 | [DR] Y.ICN-NMR Framework of Locally Enhanced Name Mapping and Resolution for Information Centric Networking in IMT-2020 [183] | Naming and name resolution for ICN | 2019-10 |
| ITU-T SG 13 | Y.3075 Requirements and capabilities of ICN routing and forwarding based on control and user plane separation in IMT-2020 [184] | Routing and forwarding in ICN | 2020-09 |
| 3GPP | [TR 23.748] Study on enhancement of support for edge computing in 5G core network (5GC) | MEC in 5G core networks | 2019-04 |
| 3GPP | [TR 23.758] Study on application architecture for enabling edge applications | Application architecture for MEC | 2019-12 |

2) *Internet Engineering Task Force (IETF)*: IETF is the main SDO of ICN. In 2012, the parallel research organization Internet Research Task Force (IRTF) launched the ICN Research Group (ICNRG) [193] as an attempt to match ongoing researches on ICN with relevant solutions for the future Internet. ICNRG has been initiating discussions and producing comprehensive guidelines for experimental activities in ICN. The first major publications of ICNRG cover ICN baseline scenarios [180], ICN research challenges [194], and ICN evaluation and security considerations [195]. For a summary of these three initial releases, please refer to [26]. More recent ICNRG's releases include two informational request-for-comment (RFC) documents related to adaptive video streaming [13] and disaster scenarios [196] use cases. RFC 8793 [197] provides an overview of two prominent ICN architectures, namely, named data networking (NDN) and content-centric networking (CCNx). In 2020, to facilitate the transition from ICN research to live deployments, ICNRG provided a number of deployment considerations in [179]. Besides, there have been two experimental RFCs: [198] specifies CCNx message encoding in a type-length-value (TLV) packet format, and [199] specifies the CCNx semantics, i.e., the set of mandatory/optional fields within the interests and content

objects messages, as well as their behavior and interpretation.

Currently, ICNRG is working on several drafts related to ongoing ICN research and development. The technical related work items include name resolution service in ICN, ICN ping and tracerout protocols specifications, content and network information discovery in CCNx, and QoS architecture for CCNx-like ICN protocols. The other technical aspects under investigation are time encoding for CCNx, flow classification and balancing, and path steering in CCNx and NDN. Some other work items focus on the applications of ICN in 3GPP 5G core network [175], LoWPAN networks [173], and opportunistic wireless networks.

3) *International Telecommunication Union (ITU)*: ITU-T Study Group (SG) 13 [200] has been investigating ICN standardization related to requirements and architecture for future networks. Their Recommendation ITU-T Y.3001 listed data awareness as an objective of future networks [201]. The data aware networking (DAN) framework was then specified in Recommendation ITU-T Y.3033 [202], whose Supplement 35 lists prominent use cases and scenarios in DAN. To realize these scenarios, the requirements and capability components of DAN were identified in Recommendation ITU-T Y.3071 [203]. The ITU also explored how to integrate ICN into IMT-

2020 networks [204]. For a summary of the aforementioned recommendations and activities, refer to [26].

We next present an update on more recent ICN standardization activities in ITU-T SG 13. In Apr. 2019, ITU-T SG 13 produced Recommendation ITU-T Y.3072 [205] that focuses on name mapping and resolution as a solution to satisfy high performance requirements such as low latency and scalability. In Aug. 2019, ITU-T SG 13 produced Recommendation ITU-T Y.3073 that presents a framework for ICN service function chaining [206]. Remarkably, it specifies a framework to apply ICN to MEC. Recommendation ITU-T Y.3075 [184] (Sep. 2020) describes service and functional requirements of routing and forwarding for ICN in IMT-2020 on the basis of separation between control and user planes with consideration of various scenarios and the security. Recommendation ITU-T Y.3076 [181] specifies the requirements for edge network with ICN functionalities in IMT-2020 from the service and network operation point of view. It provides an architecture and describes the key functions and interfaces to satisfy the requirements of ICN-enabled edge network. Then, in Sep. 2021, Recommendation Y.3077 [207] on interworking of devices within and across heterogeneous application domains through ICN was published. Most recently, Recommendation Y.3078 [208] (Feb. 2022) specifies requirements and capabilities of data object segmentation in ICN.

4) *3rd Generation Partnership Project (3GPP)*: The 3GPP [209] has been leading the development and maintenance of global wireless network generations from 2G to 5G. Their activities in 5G network specification specify the major prospective environment for MEC deployments. In Release 15, a collection of new enablers to integrate MEC in 5G networks was given in Clause 5.13 of Technical Specification (TS) 23.501 on the 5G system architecture [210]. Next, TR 23.748 [211] studies and performs evaluations of potential architecture enhancements to support MEC in the 5G Core network. It provides guidelines for the deployment of typical MEC use cases. In addition, TR 33.839 [212] studies the security enhancements on the support for MEC in the 5G Core network defined in TR 23.748, and architecture that enables edge applications defined in TR 23.758 and TS 23.558. TR 26.803 [213] studies use cases for multimedia processing at the edge and the potential 5G media streaming architecture extensions to enable them. TR 28.814 [214] studies the potential use cases, requirements, and solutions for the management of edge computing architecture and requirement defined by TS 23.558 and TS 23.501. Recently, in Release 18, the alignment with ETSI MEC from the management perspective for edge computing was studied in TR 28.903 [215]. TR 23.700-98 [216] investigates the enhanced application architecture to enable edge applications. TR 23.700-48 [217] and TR 33.739 [218] extend the study on 5G system enhancement and security enhancement for MEC, respectively.

In the 3GPP's proposed 5G Core architecture [210], ICN is enabled due to its flexibility the fact that it satisfies the needs of new services [143]. Specifically, Clause G.4.0 in [210] provides a deployment example for the Service Communication Proxy which is based on a name-based routing mechanism that provides IP over ICN capabilities. It is envisaged that the

Service Router acts as communication proxy and it is responsible for mapping IP based messages onto ICN publication and subscriptions. This kind of architectural patterns is also expected to be valid for B5G networks.

VII. LESSONS LEARNED AND FUTURE RESEARCH DIRECTIONS

In this section, we discuss the lessons learned regarding the key research areas of ICN MEC integration and their future research directions, as illustrated in Fig. 7.

A. AI, Big Data and Edge Intelligence

1) *Lessons Learned*: For solving most of the mentioned ICN MEC integration challenges, AI seems to be a promising approach. The majority of the issues in Section V about ICN MEC integration can be effectively addressed by ML and AI techniques. However, massive IoT connections and enormous data generated at the network edge would further complicate these challenges. ICN and MEC have potential features that can help with this issue (e.g., big data handling). For example, raw data can be stored at the network edge (e.g., MEC servers collocated at cellular base stations), thus removing the need to send the raw data to centralized clouds, and therefore ICN can easily distribute the data across the network. As a result, employing MEC ICN for big data processing in B5G networks is an important research subject.

In MEC networks, AI can help manage computation and caching process, while ML can be used to analyze high-level features of network context and real-time observation, and thus supporting the control functionalities of ICN MEC systems. By facilitating efficient classification at the application and network layers, ML techniques can be used to process content prefixes in ICN. AI-enabled ICN MEC is also helpful for handover, load balancing, and routing protocols by taking into account the network conditions and user information. Moreover, ML techniques such as reinforcement learning are promising for load balancing and routing algorithms in ICN. In terms of ICN security, ML approaches might not be always helpful to identify security attacks. With the more powerful attackers, feeding the previous attack models to the learning-based security solutions will not be sufficient. Instead, ICN requires more intelligent, adaptive, and robust security schemes. They can also provide more intelligent, adaptive, and robust security schemes in ICN MEC.

It is expected that MEC and ICN will continue to play their important roles in future 6G systems, where edge intelligence is a key for most emerging MEC ICN based applications such as virtual reality, fully autonomous transportation, in-car infotainment, and holographic telepresence. MEC-based near-real-time radio intelligent controllers in beyond 5G and future 6G networks can result from such deployments. MEC implementations would need to use beyond-IP network architectures to accommodate edge intelligence and emerging applications. In this regard, ICN is a potential solution thanks to its distinct advantages, such as faster and more reliable data transmission and increased reliability.

2) *Future Research Directions*: In most AI-enabled optimization solutions, the learning model is trained in offline, then deployed in a network node such as MEC server and radio tower. Although the learning models can be well trained and have high performance in the testing data set, they shall not well adapt to highly dynamic ICN MEC networks with unknown new data and tasks. To cope with such issues, the learning agents should continuously accumulate new knowledge to update the model. Since the optimization of ICN MEC systems are normally formulated as nondeterministic polynomial time (NP) problems with both continuous and binary variables, and constraint non-linearity, the optimization can be further exaggerated by the very large dimensionality of the feasible solution set. Efficiently exploiting AI techniques to solve these challenges without compromising the performance should be investigated in future studies. In this vein, the applications of different AI approaches (such as convolutional neural network, reinforcement learning, and recurrent neural network) are presented in [219].

The issues of big data storage and processing can be addressed by edge-based processing and multi-venue data storage. Learning tasks in big data processing can be distributed among multiple edge servers in order to execute more tasks and reduce the data transfer between the devices and the central cloud server. Data is sent to the cloud only if the accuracy of processing on edge servers does not satisfy the requirements. Furthermore, with ICN-based caching, data can be stored at multiple venues, e.g., among multiple edge nodes, in order to shorten the response time of satisfying the content requests of users. Efficient distributed storage and processing algorithms need to be designed to minimize the execution cost while achieving the quality requirements of big data applications. This question has been partly answered in [220]–[223]. On-device caching and heterogeneity (e.g., in resources, applications, QoS requirements) are also open issues that should be thoroughly investigated for ICN MEC integration in future networks.

Federated learning has the potential to solve the challenge of data availability and distribution. Data and caching content of different ICN MEC networks are utilized for model training at the corresponding nodes, which are then uploaded to a central server for model aggregation. To ensure a flexible coordination among network nodes (e.g., caching nodes, edge, fog, and cloud), designing proper resource management approaches in future ICN MEC networks is necessary. Moreover, efficient incentive mechanisms and business model are essential to stimulate the data sharing and training participation of network nodes. Edge AI for emerging applications in future B5G wireless systems also opens up new research opportunities.

B. Blockchain

1) *Lessons Learned*: The deployment of MEC systems and emergence of new compute-intensive and latency-critical applications at the mobile edge are indispensable in B5G networks, but also introduce many new privacy and security issues. Blockchain, with numerous distinctive features such as immutability, non-repudiation, proof of provenance, and

integrity has been considered as a promising solution to overcome privacy and security issues of ICN MEC integrated networks. For example, Zhang *et al.* [224] leveraged the use of a blockchain and smart contract to design an incentive mechanism in device-to-device assisted mobile edge caching systems. As the willingness of sharing caching codes of the edge nodes is taken into account, the proposed approach in [224] outperforms several benchmarks in terms of traffic offloading, latency, and consensus reward. Another use case of blockchain in ICN MEC systems is investigated in [225]. In particular, blockchain is adopted to guarantee secure and privacy-preserving transactions of computing resources among sellers and buyers in IoV systems.

2) *Future Research Directions*: Although blockchain offers distinctive features of decentralization and traceability to ICN MEC systems, blockchain also has its own security and privacy issues. To address these issues, blockchain-related privacy and security should be taken into account of ICN MEC research. A promising direction is leveraging blockchain for emerging applications closely related to ICN MEC realization. For example, mobile crowdsensing is advantageous to many wireless applications, but the requirements of direct access to sensing data of mobile participants may cause privacy issues. In this context, blockchain not only provides privacy-preserving solutions but also enables scalable mobile crowdsensing systems. Designing incentive approaches and economic frameworks are desirable that more edge nodes and mobile devices are encouraged to devote their computing and caching resources for better performance.

C. New Security and Privacy Challenges and Enablers

1) *Lessons Learned*: Like any mobile networks, security and privacy are significant challenges of ICN, MEC, and ICN MEC integrated systems. For example, the content delivery between a content requester and content provider in ICN is built on the design of naming policies, which may, however, cause numerous privacy issues. This is reasonable since the unique name of the content may be visible along the transmission paths. In MEC, computation offloading to the edge nodes may lead to severe security and privacy issues [226]. As a promising solution, [227] leverages the concept of *physical layer security* to design a secure offloading framework. In particular, wireless resources are optimized to maximize the minimum of computation secrecy rate subject to various design constraints. Moreover, the security and privacy issues should be properly investigated when the ICN MEC systems are integrated with other technologies such as blockchain, massive MIMO, 5G multiple access techniques, and device-to-device communications. For instance, 51% attack is a serious security issue in blockchain-based systems, which may be caused by a group of powerful miners [228]. These miners may present the adding of new blocks to the current chain and/or modify the block data for malicious purposes.

2) *Future Research Directions*: Future ICN MEC systems will comprise heterogeneous network devices with numerous computing capabilities and different constraints on security and privacy. Deploying only one mechanism/technique is not

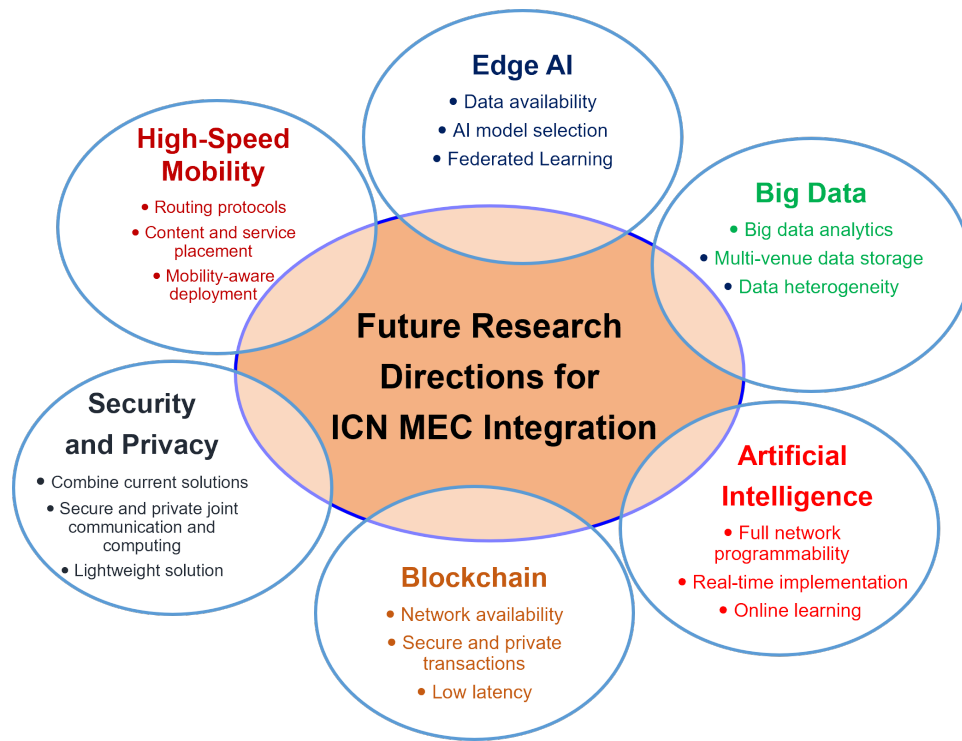

Fig. 7. Future research directions for ICN MEC integration.

sufficient to meet more and more stringent requirements, and thus require the deployment and harmonization of multiple approaches simultaneously. In this context, blockchain, federated learning, and quantum computing are promising concepts to provide innovative security and privacy techniques. The application of blockchain for naming policies in ICN networks is investigated in [229], where blockchain is used to trace the entire content delivery process so as to detect the possible locations of malicious ICN nodes. This work also leverages blockchain to design an efficient naming alternative scheme between human-readable names and self-certifying names. Moreover, new security and privacy methods should be low-complexity, low-cost, and scalable so that they will be deployable for massive and large-scale ICN MEC systems.

D. High-Speed Mobility

1) *Lessons Learned*: As long-distance and high-speed communications will be an integral component of future B5G wireless networks, ICN MEC integrated networks should be designed to meet such new requirements. An example of this case is an express train that shall operate at up to 500 km/h in the next decade. Together with many new services of joint communication, computing, caching, control, and sensing, the current network infrastructure of ICN MEC systems would not be able to support such scenarios. Here, a promising solution is the design of a comprehensive multi-tier and heterogeneous B5G infrastructure. In particular, the amalgamation of terrestrial communications, low-altitude and high-altitude platforms, and satellite communications in 6G is expected to provide communication and computing services at a globe level and with various quality of service (QoS) levels

[230]. Obviously, the high-speed trains, when connected with only terrestrial communication systems, may cause frequent handovers among cellular cells, and thus reduce the network performance. To cope with this challenge, a satellite terrestrial integrated network was proposed in [231] to improve the performance of high-speed railway systems in terms of data throughput and transmission latency.

2) *Future Research Directions*: Despite mobility issues of end users and edge nodes, most of existing works ignore the practical deployment issues of ICN MEC systems, which should be thoroughly investigated in the future. One potential research direction is to exploit mobility patterns to design adaptive mechanisms of caching, computing, and content routing. This issue has been partially addressed in some recent studies such as content-centric multi-regional video content adaptability in [232] and adaptive video streaming in [233]. Network softwarization is a promising concept that can be leveraged to address mobility issues. For example, the work in [234] proposes deploying software-defined networking to offer new features for vehicular communication networks such as application portability, immutability, and scalability, and thus maintaining service continuity and supporting user mobility. Furthermore, AI approaches are promising to increase the realtime implementation thanks to features learned from the massive amounts of mobile data generated in ICN MEC systems.

E. The Integrated View: ICN MEC Impact for B5G Based on Lessons Learned

In this section, we make the connection between the B5G challenges and relevant use cases elaborated in Section IV and

TABLE V
ICN MEC RESEARCH DIRECTIONS AND THEIR IMPACT ON USE CASES AND CHALLENGES.

| Research Directions | Challenges | | | | | | | | Use cases | | | | |
|--|------------------------------|-------------------|----------|---------|--------|----------|-----------------|-------------------|--------------|----------------------|--------------------|------------------|------------|
| | Deployment and orchestration | Context awareness | Security | Privacy | Naming | Mobility | Network slicing | Big data handling | Smart cities | Networked multimedia | Vehicular networks | Smart Healthcare | Smart Grid |
| Edge AI | | | | | | | | | | | | | |
| Collaborative computing and caching at edge node | L | M | L | H | H | M | L | H | H | H | H | M | L |
| Data availability | L | H | H | H | M | M | L | H | H | H | L | H | L |
| AI model selection | M | M | H | H | L | L | L | H | H | L | L | H | L |
| Federated learning | M | H | M | H | L | L | L | H | H | L | L | H | L |
| Big Data | | | | | | | | | | | | | |
| Data sharing and resource optimization | L | H | H | H | M | L | L | H | H | M | H | H | L |
| Big data analytics for content caching | L | H | M | M | H | M | L | H | H | H | H | M | L |
| Multi-venue distributed data storage | H | H | H | H | H | L | L | H | H | H | H | M | M |
| Data heterogeneity | L | H | H | H | H | L | L | H | H | H | M | H | L |
| Learning Techniques and AI | | | | | | | | | | | | | |
| Full network programmability | H | L | M | M | H | H | H | L | H | H | H | H | H |
| Real time implementation of iterative AI algorithms | M | H | L | L | L | L | L | H | H | M | H | L | M |
| Balance between optimality and efficiency | H | H | L | L | L | L | L | H | H | M | L | H | M |
| Dynamic and online learning | H | H | H | M | L | M | M | H | H | L | L | H | H |
| Explainable AI | H | H | H | H | H | L | L | H | M | L | L | M | M |
| Blockchain | | | | | | | | | | | | | |
| Network scalability | H | L | H | H | H | H | H | M | M | H | H | H | M |
| Secure and private transactions | H | L | H | H | M | L | L | H | H | L | M | H | M |
| Low-latency blockchain-enabled systems | H | L | H | H | M | H | H | H | H | L | H | H | M |
| New Security and Privacy Challenges and Enablers | | | | | | | | | | | | | |
| Integration of current security & privacy solutions in MEC & ICN | H | M | H | H | H | H | M | H | H | M | H | H | H |
| Secure and private joint communication, computing, caching, control, and sensing | H | H | H | H | H | M | M | H | H | M | H | H | H |
| Secure and private distributed learning | L | H | H | H | M | L | L | H | H | L | L | H | M |
| Lightweight solution design | H | M | H | H | M | L | M | H | H | M | H | H | M |
| High-speed mobility | | | | | | | | | | | | | |
| Mobility support in routing protocols | H | L | M | M | H | H | H | L | H | H | H | L | L |
| Content and service placement | H | L | H | H | H | H | M | H | H | H | H | L | M |
| Request coordination | M | L | L | L | H | H | H | H | H | H | H | L | L |
| Practical deployment based on mobility patterns | H | H | L | M | L | H | H | L | H | H | H | M | L |

L Low Relevance

M Medium Relevance

H High Relevance

V, and the lessons learned and future research directions. To this end, the impact of identified research directions for key B5G ICN MEC challenges and use cases are quantified in Table V. In that table, we essentially delineate the synthesis of the lessons learned and future research directions in our survey work in a B5G and ICN MEC context.

As apparent in the table, **Edge AI** research and lessons learned are particularly relevant for edge-driven Smart “X” use cases such as smart homes and cities, and smart healthcare. Moreover, it has high relevance and impact for security and privacy since research on AI model selection or federated learning and lessons from the related literature will have utility to alleviate security and privacy issues in B5G. **Big data** research direction has a similar impact, but with a larger set of challenges and use cases including additionally, for

instance, vehicular networks where multi-venue distributed data storage and big data analytics for content caching will be important. Both research directions have a relatively low impact on network slicing and mobility as expected.

Future research on widely-applicable key technologies such as **learning techniques and AI** and **blockchain** will have impact on a broad set of ICN MEC challenges and use cases in B5G. Research on full network programmability will serve all use cases as a fundamental enabler in ICN MEC networking. Dynamic and online learning are especially relevant for use cases and challenges related to dynamic contexts such as deployment and orchestration, and smart healthcare. Similarly, explainable AI research will provide support for big data handling and security/privacy issues since AI-driven techniques require more transparency and explainability in

future networks. Real time implementation of iterative AI algorithms will be highly instrumental to address challenges related to management, security, privacy and how big data is handled. The research on balance between optimality and efficiency of ML/AI schemes will be important for more resource-aware situations where a trade-off can be considered such as big data handling or smart healthcare. This broad impact of AI/ML on various use cases and challenges is also valid for blockchain research on network scalability and low-latency blockchain-enabled systems since efficiency and scale constraints are important for any blockchain based solutions. Additionally, blockchain based secure and private transactions will inherently alleviate B5G security and privacy challenges and sensitive use cases such as smart cities and healthcare.

Security and privacy are transversal requirements expected to become more challenging for B5G networks. Therefore, research combining current security and privacy solutions in MEC and ICN, and secure and private joint communication, computing, and caching in future networks are generally useful to address the challenges and thus serve B5G applications. As distributed learning techniques will play a key role in these systems, secure and private distributed learning related research has high relevance for challenges and use cases except a few less impacted such as network slicing. Similarly, lightweight security solution design is relevant for many of the use cases and challenges.

The **high-speed mobility and scalability due to small-cell networks** related lessons and research will particularly benefit the mobility- and RAN-sensitive use cases. For the former, mobility support in routing protocols, and content/service placement for ICN MEC are beneficial for B5G. For the latter, interference management and computation offloading will have a significant impact in the edge networks. As expected, high-speed mobility oriented research has relevance for challenges and use cases linked to mobility such as orchestration, naming, vehicular networks, and smart cities. These two aspects are also intrinsically linked to automated/intelligent network softwarization direction since B5G networks are expected to be fully softwarized and intelligent.

VIII. CONCLUSION

The convergence of MEC and ICN technologies has potential to efficiently realize B5G applications and services. Thus, both paradigms are envisaged to be integral elements of future network ecosystems. The cooperation of MEC and ICN technologies will offer benefits such as faster content delivery, improved application level reconfiguration, improved storage and caching functions at the edges, efficient of session mobility, enable high mobility support, better support for real-time context aware applications, and content-based security. These integrated benefits will be highly useful for 5G as well as B5G applications such as smart cities, smart homes, networked multimedia applications, autonomous driving cars, and smart healthcare. However, proper integration of MEC and ICN as well as utilization and implementation in future networks is still an open question. Moreover, the implications of ICN MEC integration will open up challenges and obstacles

such as new security, privacy, orchestration, naming, mobility, and big data dissemination issues. Such challenges have to be resolved to obtain the full benefit of ICN MEC integration. SDOs have a significant responsibility to promote the ICN MEC integration by further extending their standardization activities.

Finally, other related network technologies such as Edge AI, big data, learning techniques, and blockchain can be used to enable an efficient integration of ICN and MEC for Beyond 5G networks. From AI and smart networks perspective, efficiently exploiting AI techniques and their application to solve these challenges without compromising the performance should be investigated in future work. Efficient resource management approaches for future ICN MEC networks are necessary for advanced learning techniques. Research on incentive mechanisms and business models to boost data sharing and training participation of network nodes is also crucial.

Similar to the AI aspect, designing incentive approaches and economic frameworks for blockchain technology integration into ICN MEC will encourage more edge nodes and mobile devices to devote their computing and caching resources for performance improvements. Future ICN MEC systems will particularly comprise heterogeneous network elements with different requirements on security and privacy. In this context, new security and privacy enablers such as blockchain and edge AI should be scalable and low-cost to be deployable in integrated modes for ICN MEC systems. In addition to security aspect, ICN MEC integrated future networks is expected to meet such long-distance and high-speed communication requirements. Therefore, design of adaptive mechanisms of caching, computing, and content routing for high-speed mobility is an important research topic. Along these open questions, new research directions and related solutions can also be further investigated in future iterations of this survey.

ACKNOWLEDGEMENT

This work is partly supported by Academy of Finland under 6Genesis (grant no. 318927) project. Khac-Hoang Ngo has received funding from the European Union's Horizon 2020 research and innovation programme under the Marie Skłodowska-Curie grant agreement No 101022113.

REFERENCES

- [1] G. Gür, P. Porambage, and M. Liyanage, "Convergence of ICN and MEC for 5G: Opportunities and challenges," *IEEE Communications Standards Magazine*, vol. 4, no. 4, pp. 64–71, 2020.
- [2] ETSI, "Multi-Access Edge Computing (MEC); Framework and reference architecture," ETSI, Group Specification MEC 003 V2.2.1, Dec. 2020. [Online]. Available: https://www.etsi.org/deliver/etsi_gs/MEC/001_099/003/02.02.01_60/gs_MEC003v020201p.pdf
- [3] Q.-V. Pham, F. Fang, V. N. Ha, M. J. Piran, M. Le, L. B. Le, W.-J. Hwang, and Z. Ding, "A survey of multi-access edge computing in 5G and beyond: Fundamentals, technology integration, and state-of-the-art," *IEEE Access*, vol. 8, pp. 116 974–117 017, 2020.
- [4] ETSI, "Mobile Edge Computing (MEC); MEC 5G Integration ETSI GR MEC 031 V2.1.1 (2020-10)," ETSI Industry Specification Group (ISG) Group Report, October 2020. [Online]. Available: https://www.etsi.org/deliver/etsi_gr/MEC/001_099/031/02.01.01_60/gr_MEC031v020101p.pdf
- [5] N. Abbas, Y. Zhang, A. Taherkordi, and T. Skeie, "Mobile edge computing: A survey," *IEEE Internet of Things Journal*, vol. 5, no. 1, pp. 450–465, 2018.

- [6] J. Nakazato, M. Nakamura, Y. Tao, G. K. Tran, and K. Sakaguchi, "Benefits of MEC in 5G cellular networks from telecom operator's view points," in *2019 IEEE Global Communications Conference (GLOBECOM)*, 2019, pp. 1–7.
- [7] Meticulous Research, "Mobile Edge Computing market by component, application, organization size, and region - global forecast to 2027," Accessed: Mar. 17, 2021. [Online]. Available: <https://www.meticulousresearch.com/product/mobile-edge-computing-market-5120>
- [8] Q.-V. Pham, R. Ruby, F. Fang, D. C. Nguyen, Z. Yang, M. Le, Z. Ding, and W.-J. Hwang, "Aerial computing: A new computing paradigm, applications, and challenges," *IEEE Internet of Things Journal*, 2022.
- [9] G. Gür, "Expansive networks: Exploiting spectrum sharing for capacity boost and 6G vision," *Journal of Communications and Networks*, vol. 22, no. 6, pp. 444–454, 2020.
- [10] T. Zahariadis, D. Papadimitriou, H. Tschofenig, S. Haller, P. Daras, G. D. Stamoulis, and M. Hauswirth, "Towards a future internet architecture," in *The Future Internet*, J. Domingue, A. Galis, A. Gavras, T. Zahariadis, D. Lambert, F. Cleary, P. Daras, S. Krco, H. Müller, M.-S. Li, H. Schaffers, V. Lotz, F. Alvarez, B. Stiller, S. Karnouskos, S. Avessta, and M. Nilsson, Eds. Berlin, Heidelberg: Springer Berlin Heidelberg, 2011, pp. 7–18.
- [11] G. Gür, "Energy-aware cache management at the wireless network edge for information-centric operation," *Journal of Network and Computer Applications*, vol. 57, pp. 33 – 42, 2015.
- [12] M. Conti, A. Gangwal, M. Hassan, C. Lal, and E. Losiouk, "The road ahead for networking: A survey on ICN-IP coexistence solutions," *IEEE Communications Surveys Tutorials*, vol. 22, no. 3, pp. 2104–2129, 2020.
- [13] C. Westphal, S. Lederer, C. Mueller, A. Detti, D. Corujo, J. Wang, M.-J. Montpetit, N. Murray, C. Timmerer, D. Posch, A. Azgin, and W. S. LIU, "Adaptive video streaming over information-centric networking (ICN)," IETF, Request for Comments (RFC) 7933, Aug. 2016. [Online]. Available: <https://rfc-editor.org/rfc/rfc7933.txt>
- [14] B. Ahlgren, C. Dannewitz, C. Imbrenda, D. Kutscher, and B. Ohlman, "A survey of information-centric networking," *IEEE Commun. Mag.*, vol. 50, no. 7, pp. 26–36, July 2012.
- [15] Cisco, "Cisco Visual Networking Index: Global mobile data traffic forecast update, 2017-2022," February 2018.
- [16] Sandvine, "Sandvine Global Internet Phenomena Report 2018," October 2018.
- [17] R. Ullah, M. A. U. Rehman, M. A. Naem, B.-S. Kim, and S. Mastorakis, "ICN with edge for 5G: Exploiting in-network caching in ICN-based edge computing for 5G networks," *Future Generation Computer Systems*, vol. 111, pp. 159–174, 2020.
- [18] H. Khelifi, S. Luo, B. Nour, and H. Mounгла, "In-network caching in ICN-based vehicular networks: Effectiveness performance evaluation," in *ICC 2020 - 2020 IEEE International Conference on Communications (ICC)*, 2020, pp. 1–6.
- [19] C. Fang, H. Yao, Z. Wang, Y. Tu, and Y. Chen, "Edge cache-based intelligent content delivery in information-centric wireless networks," in *2018 1st IEEE International Conference on Hot Information-Centric Networking (HotICN)*, 2018, pp. 236–237.
- [20] B. Nour, K. Sharif, F. Li, S. Biswas, H. Mounгла, M. Guizani, and Y. Wang, "A survey of Internet of Things communication using ICN: A use case perspective," *Computer Communications*, vol. 142-143, pp. 95–123, 2019.
- [21] Y. Hua, L. Guan, and K. G. Kyriakopoulos, "A fog caching scheme enabled by ICN for IoT environments," *Future Generation Computer Systems*, vol. 111, pp. 82–95, 2020.
- [22] T. Zhang, X. Fang, Y. Liu, and A. Nallanathan, "Content-centric mobile edge caching," *IEEE Access*, vol. 8, pp. 11 722–11 731, 2020.
- [23] P. Ranaweera, A. D. Jurchut, and M. Liyanage, "Survey on multi-access edge computing security and privacy," *IEEE Communications Surveys Tutorials*, pp. 1–1, 2021.
- [24] C. Fang, H. Yao, Z. Wang, W. Wu, X. Jin, and F. R. Yu, "A survey of mobile information-centric networking: Research issues and challenges," *IEEE Communications Surveys Tutorials*, vol. 20, no. 3, pp. 2353–2371, 2018.
- [25] Q. Zhang, X. Wang, M. Huang, K. Li, and S. K. Das, "Software defined networking meets information centric networking: A survey," *IEEE Access*, vol. 6, pp. 39 547–39 563, 2018.
- [26] K. Yu, S. Eum, T. Kurita, Q. Hua, T. Sato, H. Nakazato, T. Asami, and V. P. Kafle, "Information-centric networking: Research and standardization status," *IEEE Access*, vol. 7, pp. 126 164–126 176, 2019.
- [27] G. Xylomenos, C. N. Ververidis, V. A. Siris, N. Fotiou, C. Tsilopoulos, X. Vasilakos, K. V. Katsaros, and G. C. Polyzos, "A survey of information-centric networking research," *IEEE communications surveys & tutorials*, vol. 16, no. 2, pp. 1024–1049, 2013.
- [28] Y. Mao, C. You, J. Zhang, K. Huang, and K. B. Letaief, "A survey on mobile edge computing: The communication perspective," *Communications Surveys & Tutorials*, vol. 19, no. 4, pp. 2322–2358, 2017.
- [29] A. Filali, A. Abouaomar, S. Cherkaoui, A. Kobbane, and M. Guizani, "Multi-access edge computing: A survey," *IEEE Access*, vol. 8, pp. 197 017–197 046, 2020.
- [30] T. Taleb, K. Samdanis, B. Mada, H. Flinck, S. Dutta, and D. Sabella, "On multi-access edge computing: A survey of the emerging 5G network edge architecture & orchestration," *Communications Surveys & Tutorials*, vol. 19, no. 3, pp. 1657–1681, 2017.
- [31] F. Spinelli and V. Mancuso, "Toward enabled industrial verticals in 5G: A survey on MEC-based approaches to provisioning and flexibility," *IEEE Communications Surveys Tutorials*, vol. 23, no. 1, pp. 596–630, 2021.
- [32] P. Mach and Z. Becvar, "Mobile edge computing: A survey on architecture and computation offloading," *IEEE Communications Surveys Tutorials*, vol. 19, no. 3, pp. 1628–1656, 2017.
- [33] D. Grewe, M. Wagner, M. Arumathurai, I. Psaras, and D. Kutscher, "Information-centric mobile edge computing for connected vehicle environments: Challenges and research directions," in *Proceedings of the Workshop on Mobile Edge Communications*, 2017, pp. 7–12.
- [34] A. Antony Franklin and S. D. Tambe, "Multi-access edge computing in cellular networks," *CSI Transactions on ICT*, vol. 8, pp. 85–92, 2020.
- [35] Y. Liu, M. Peng, G. Shou, Y. Chen, and S. Chen, "Toward edge intelligence: Multiaccess edge computing for 5G and Internet of Things," *IEEE Internet of Things Journal*, vol. 7, no. 8, pp. 6722–6747, 2020.
- [36] O. Serhane, K. Yahyaoui, B. Nour, and H. Mounгла, "A survey of icn content naming and in-network caching in 5g and beyond networks," *IEEE Internet of Things Journal*, vol. 8, no. 6, pp. 4081–4104, 2021.
- [37] L. A. Haibeh, M. C. E. Yagoub, and A. Jarray, "A survey on mobile edge computing infrastructure: Design, resource management, and optimization approaches," *IEEE Access*, vol. 10, pp. 27 591–27 610, 2022.
- [38] P. Porambage, J. Okwuibe, M. Liyanage, M. Ylianttila, and T. Taleb, "Survey on multi-access edge computing for Internet of Things realization," *IEEE Communications Surveys & Tutorials*, vol. 20, no. 4, pp. 2961–2991, 2018.
- [39] Q.-V. Pham, H. T. Nguyen, Z. Han, and W.-J. Hwang, "Coalitional games for computation offloading in NOMA-enabled multi-access edge computing," *IEEE Transactions on Vehicular Technology*, vol. 69, no. 2, pp. 1982–1993, 2020.
- [40] "ETSI Multi-access Edge Computing (MEC) Industry Specification Group (ISG)," Accessed: Feb. 26, 2021. [Online]. Available: <https://www.etsi.org/technologies/multi-access-edge-computing>
- [41] Q.-V. Pham, L. B. Le, S.-H. Chung, and W.-J. Hwang, "Mobile edge computing with wireless backhaul: Joint task offloading and resource allocation," *IEEE Access*, vol. 7, pp. 16 444–16 459, 2019.
- [42] Y. Siriwardhana, P. Porambage, M. Liyanage, and M. Ylianttila, "A survey on mobile augmented reality with 5G mobile edge computing: Architectures, applications and technical aspects," *IEEE Communications Surveys Tutorials*, pp. 1–1, 2021.
- [43] T. Taleb, S. Dutta, A. Ksentini, M. Iqbal, and H. Flinck, "Mobile Edge Computing Potential in Making Cities Smarter," *Communications Magazine*, vol. 55, no. 3, pp. 38–43, 2017.
- [44] S. K. Sharma and X. Wang, "Live data analytics with collaborative edge and cloud processing in wireless IoT networks," *Access*, vol. 5, pp. 4621–4635, 2017.
- [45] R. Vilalta, V. Lopez, A. Giorgetti, S. Peng, V. Orsini, L. Velasco, R. Serral-Gracia, D. Morris, S. De Fina, F. Cugini *et al.*, "TelcoFog: A Unified Flexible Fog and Cloud Computing Architecture for 5G Networks," *Communications Magazine*, vol. 55, no. 8, pp. 36–43, 2017.
- [46] V. Jacobson, D. K. Smetters, J. D. Thornton, M. F. Plass, N. H. Briggs, and R. L. Braynard, "Networking named content," in *Proceedings of the 5th international conference on Emerging networking experiments and technologies*, 2009, pp. 1–12.
- [47] L. Zhang, D. Estrin, J. Burke, V. Jacobson, J. D. Thornton, D. K. Smetters, B. Zhang, G. Tsudik, D. Massey, C. Papadopoulos *et al.*, "Named data networking (NDN) project," *Relatório Técnico NDN-0001, Xerox Palo Alto Research Center-PARC*, vol. 157, p. 158, 2010.
- [48] I. U. Din, S. Hassan, M. K. Khan, M. Guizani, O. Ghazali, and A. Habbal, "Caching in information-centric networking: Strategies, challenges, and future research directions," *IEEE Communications Surveys Tutorials*, vol. 20, no. 2, pp. 1443–1474, 2018.

- [49] A. Kalla and S. K. Sharma, "A constructive review of in-network caching: A core functionality of ICN," in *2016 International Conference on Computing, Communication and Automation (ICCCA)*. IEEE, 2016, pp. 567–574.
- [50] R. Ullah, M. A. U. Rehman, and B. S. Kim, "Hierarchical name-based mechanism for push-data broadcast control in information-centric multihop wireless networks," *Sensors*, vol. 19, no. 14, p. 3034, 2019.
- [51] G. Carofiglio, L. Mekinda, and L. Muscariello, "LAC: Introducing latency-aware caching in information-centric networks," in *2015 IEEE 40th Conference on Local Computer Networks (LCN)*. IEEE, 2015, pp. 422–425.
- [52] L. Nkenyerere, J. Hwang, Q.-V. Pham, and J. Song, "MEIX: Evolving multi-access edge computing for industrial internet-of-things services," *IEEE Network*, vol. 35, no. 3, pp. 147–153, 2021.
- [53] R. Ravindran, A. Chakraborti, S. O. Amin, A. Azgin, and G. Wang, "5G-ICN: Delivering ICN services over 5G using network slicing," *IEEE Communications Magazine*, vol. 55, no. 5, pp. 101–107, May 2017.
- [54] T. Braun, A. Mauthe, and V. Siris, "Service-centric networking extensions," in *Proceedings of the 28th Annual ACM Symposium on Applied Computing*, 2013, pp. 583–590.
- [55] G. Zhang, Y. Li, and T. Lin, "Caching in information centric networking: A survey," *Computer Networks*, vol. 57, no. 16, pp. 3128–3141, 2013.
- [56] S. H. Mortazavi, B. Balasubramanian, E. de Lara, and S. P. Narayanan, "Toward session consistency for the edge," in *USENIX Workshop on Hot Topics in Edge Computing (HotEdge 18)*, 2018.
- [57] G. Tyson, N. Sastry, I. Rimac, R. Cuevas, and A. Mauthe, "A survey of mobility in information-centric networks: Challenges and research directions," in *Proceedings of the 1st ACM workshop on Emerging Name-Oriented Mobile Networking Design-Architecture, Algorithms, and Applications*, 2012, pp. 1–6.
- [58] E. Ahmed, M. Imran, M. Guizani, A. Rayes, J. Lloret, G. Han, and W. Guibene, "Enabling mobile and wireless technologies for smart cities," *IEEE Commun. Mag.*, vol. 55, no. 1, pp. 74–75, 2017.
- [59] A. Lertsinsruttavee, M. Selimi, A. Sathiaseelan, L. Cerdà-Alabern, L. Navarro, and J. Crowcroft, "Information-centric multi-access edge computing platform for community mesh networks," in *Proceedings of the 1st ACM SIGCAS Conference on Computing and Sustainable Societies*, ser. COMPASS '18. New York, NY, USA: ACM, 2018.
- [60] I. Parvez, A. Rahmati, I. Guvenc, A. I. Sarwat, and H. Dai, "A survey on low latency towards 5G: RAN, core network and caching solutions," *IEEE Communications Surveys Tutorials*, vol. 20, no. 4, pp. 3098–3130, 2018.
- [61] M. Maier, M. Chowdhury, B. P. Rimal, and D. P. Van, "The tactile internet: Vision, recent progress, and open challenges," *IEEE Communications Magazine*, vol. 54, no. 5, pp. 138–145, 2016.
- [62] M. Amadeo, C. Campolo, G. Ruggeri, G. Lia, and A. Molinaro, "Caching transient contents in vehicular named data networking: A performance analysis," *Sensors*, vol. 20, no. 7, 2020. [Online]. Available: <https://www.mdpi.com/1424-8220/20/7/1985>
- [63] I. U. Din, B.-S. Kim, S. Hassan, M. Guizani, M. Atiquzzaman, and J. J. P. C. Rodrigues, "Information-centric network-based vehicular communications: Overview and research opportunities," *Sensors*, vol. 18, no. 11, 2018. [Online]. Available: <https://www.mdpi.com/1424-8220/18/11/3957>
- [64] R. Tourani, S. Misra, T. Mick, and G. Panwar, "Security, privacy, and access control in information-centric networking: A survey," *IEEE communications surveys & tutorials*, vol. 20, no. 1, pp. 566–600, 2017.
- [65] C.-A. Sarros, A. Lertsinsruttavee, C. Molina-Jimenez, K. Prasopoulos, S. Diamantopoulos, D. Vardalis, and A. Sathiaseelan, "ICN-based edge service deployment in challenged networks," in *Proceedings of the 4th ACM Conference on Information-Centric Networking*, ser. ICN '17. New York, NY, USA: ACM, 2017, p. 210–211.
- [66] I. F. Akyildiz, A. Kak, and S. Nie, "6G and beyond: The future of wireless communications systems," *IEEE Access*, vol. 8, pp. 133 995–134 030, 2020.
- [67] W. Saad, M. Bennis, and M. Chen, "A vision of 6G wireless systems: Applications, trends, technologies, and open research problems," *IEEE network*, vol. 34, no. 3, pp. 134–142, 2019.
- [68] "6G Flagship Project," Accessed: Feb. 26, 2021. [Online]. Available: <https://www.oulu.fi/6gflagship/>
- [69] F. Tariq, M. R. A. Khandaker, K. K. Wong, M. A. Imran, M. Bennis, and M. Debbah, "A speculative study on 6g," *IEEE Wireless Communications*, vol. 27, no. 4, pp. 118–125, 2020.
- [70] J. Jin, J. Gubbi, S. Marusic, and M. Palaniswami, "An information framework for creating a smart city through Internet of Things," *IEEE Internet of Things journal*, vol. 1, no. 2, pp. 112–121, 2014.
- [71] A. Camero and E. Alba, "Smart city and information technology: A review," *Cities*, vol. 93, pp. 84–94, 2019.
- [72] A. Sinaeepourfard, J. Garcia, X. Masip-Bruin, E. Marín-Tordera, J. Cirera, G. Grau, and F. Casaus, "Estimating smart city sensors data generation," in *2016 Mediterranean Ad Hoc Networking Workshop (Med-Hoc-Net)*. IEEE, 2016, pp. 1–8.
- [73] M. M. Rathore, A. Paul, A. Ahmad, and G. Jeon, "IoT-based Big Data: From Smart City towards next generation super city planning," *International Journal on Semantic Web and Information Systems (IJSWIS)*, vol. 13, no. 1, pp. 28–47, 2017.
- [74] B. L. R. Stojkoska and K. V. Trivodaliev, "A review of Internet of Things for smart home: Challenges and solutions," *Journal of Cleaner Production*, vol. 140, pp. 1454–1464, 2017.
- [75] S. A. Hossain, M. A. Rahman, and M. A. Hossain, "Edge computing framework for enabling situation awareness in IoT based smart city," *Journal of Parallel and Distributed Computing*, vol. 122, pp. 226–237, 2018.
- [76] L. Wang, A. Afanasyev, R. Kuntz, R. Vuyyuru, R. Wakikawa, and L. Zhang, "Rapid traffic information dissemination using named data," in *Proceedings of the 1st ACM workshop on emerging name-oriented mobile networking design-architecture, algorithms, and applications*, 2012, pp. 7–12.
- [77] D. Wang, B. Bai, K. Lei, W. Zhao, Y. Yang, and Z. Han, "Enhancing information security via physical layer approaches in heterogeneous IoT with multiple access mobile edge computing in smart city," *IEEE Access*, vol. 7, pp. 54 508–54 521, 2019.
- [78] Y. Deng, Z. Chen, X. Yao, S. Hassan, and J. Wu, "Task scheduling for smart city applications based on multi-server mobile edge computing," *IEEE Access*, vol. 7, pp. 14 410–14 421, 2019.
- [79] S. Husain, A. Kunz, A. Prasad, K. Samdanis, and J. Song, "Mobile edge computing with network resource slicing for Internet-of-Things," in *2018 IEEE 4th World Forum on Internet of Things (WF-IoT)*. IEEE, 2018, pp. 1–6.
- [80] R. Trimananda, A. Younis, B. Wang, B. Xu, B. Demsky, and G. Xu, "Vigilia: Securing smart home edge computing," in *2018 IEEE/ACM Symposium on Edge Computing (SEC)*. IEEE, 2018, pp. 74–89.
- [81] G. Piro, L. A. Grieco, G. Boggia, and P. Chatzimisios, "Information-centric networking and multimedia services: Present and future challenges," *Transactions on Emerging Telecommunications Technologies*, vol. 25, no. 4, pp. 392–406, 2014.
- [82] J. Zhang, Q. Li, and E. M. Schooler, "iHEMS: An information-centric approach to secure home energy management," in *2012 IEEE Third International Conference on Smart Grid Communications (SmartGrid-Comm)*, Tainan, Taiwan, Nov. 2012, pp. 217–222.
- [83] "Cisco Annual Internet Report (2018–2023) White Paper," Accessed: Mar. 17, 2021. [Online]. Available: <https://www.cisco.com/c/en/us/solutions/collateral/executive-perspectives/annual-internet-report/white-paper-c11-741490.html>
- [84] C. de Alwis, H. K. Arachchi, V. De Silva, A. Fernando, and A. Kondoz, "Robust video communication using random linear network coding with pre-coding and interleaving," in *2012 19th IEEE International Conference on Image Processing*. IEEE, 2012, pp. 2269–2272.
- [85] C. de Alwis, H. K. Arachchi, A. Fernando, and M. Pourazad, "Content and network-aware multicast over wireless networks," in *10th International Conference on Heterogeneous Networking for Quality, Reliability, Security and Robustness*. IEEE, 2014, pp. 122–128.
- [86] I. U. Din, H. Asmat, and M. Guizani, "A review of information centric network-based internet of things: communication architectures, design issues, and research opportunities," *Multimedia Tools and Applications*, vol. 78, no. 21, pp. 30 241–30 256, 2019.
- [87] C. Long, Y. Cao, T. Jiang, and Q. Zhang, "Edge computing framework for cooperative video processing in multimedia IoT systems," *IEEE Transactions on Multimedia*, vol. 20, no. 5, pp. 1126–1139, 2017.
- [88] J. Martín-Pérez, L. Cominardi, C. J. Bernardos, A. de la Oliva, and A. Azcorra, "Modeling mobile edge computing deployments for low latency multimedia services," *IEEE Transactions on Broadcasting*, vol. 65, no. 2, pp. 464–474, 2019.
- [89] M. Jridi, T. Chapel, V. Dorez, G. Le Bougeant, and A. Le Botlan, "SoC-based edge computing gateway in the context of the internet of multimedia things: experimental platform," *Journal of Low Power Electronics and Applications*, vol. 8, no. 1, p. 1, 2018.
- [90] Y. Tang, K. Guo, J. Ma, Y. Shen, and T. Chi, "A smart caching mechanism for mobile multimedia in information centric networking

- with edge computing,” *Future Generation Computer Systems*, vol. 91, pp. 590–600, Feb. 2019.
- [91] X. Zhang and Q. Zhu, “Hierarchical caching for statistical QoS guaranteed multimedia transmissions over 5G edge computing mobile wireless networks,” *IEEE Wireless Communications*, vol. 25, no. 3, pp. 12–20, 2018.
- [92] Y. Zhou, F. R. Yu, J. Chen, and Y. Kuo, “Resource allocation for information centric virtualized heterogeneous networks with in-network caching and mobile edge computing,” *Transactions on Vehicular Technology*, vol. 66, no. 12, pp. 11 339–11 351, 2017.
- [93] Y. Tang, “Minimizing energy for caching resource allocation in information-centric networking with mobile edge computing,” in *2019 IEEE Intl Conf on Dependable, Autonomic and Secure Computing, Intl Conf on Pervasive Intelligence and Computing, Intl Conf on Cloud and Big Data Computing, Intl Conf on Cyber Science and Technology Congress (DAsC/PiCom/CBDCom/CyberSciTech)*. IEEE, 2019, pp. 301–304.
- [94] T.-M. I. Băjenescu, “5G: The network of the future. benefits and perils,” *Electrotehnica, Electronica, Automatica*, vol. 68, no. 3, pp. 75–79, 2020.
- [95] T. Raviteja, “An introduction of autonomous vehicles and a brief survey,” *Journal of Critical Reviews*, vol. 7, no. 13, pp. 196–202, 2020.
- [96] N. Jayaweera, N. Rajatheva, and M. Latva-aho, “Autonomous driving without a burden: View from outside with elevated lidar,” in *2019 IEEE 89th Vehicular Technology Conference (VTC2019-Spring)*. IEEE, 2019, pp. 1–7.
- [97] B. Krzanich, “Intel. data is the new oil in the future of automated driving.” 2019.
- [98] I. Yaqoob, L. U. Khan, S. A. Kazmi, M. Imran, N. Guizani, and C. S. Hong, “Autonomous driving cars in smart cities: Recent advances, requirements, and challenges,” *IEEE Network*, vol. 34, no. 1, pp. 174–181, 2019.
- [99] H. Jin, D. Xu, C. Zhao, and D. Liang, “Information-centric mobile caching network frameworks and caching optimization: a survey,” *EURASIP Journal on Wireless Communications and Networking*, vol. 2017, no. 1, p. 33, 2017.
- [100] R. Ravindran, P. Suthar, A. Chakraborti, S. O. Amin, A. Azgin, and G. Wang, “Deploying ICN in 3GPP’s 5G nextgen core architecture,” in *2018 IEEE 5G World Forum (5GWF)*. IEEE, 2018, pp. 26–32.
- [101] M. Wang, J. Wu, G. Li, J. Li, Q. Li, and S. Wang, “Toward mobility support for information-centric IoV in smart city using fog computing,” in *2017 IEEE International Conference on Smart Energy Grid Engineering (SEGE)*. IEEE, 2017, pp. 357–361.
- [102] J. Li, J. Wu, G. Xu, J. Li, X. Zheng, and A. Jolfaci, “Integrating NFV and ICN for advanced driver-assistance systems,” *IEEE Internet of Things Journal*, vol. 7, no. 7, pp. 5861–5873, 2019.
- [103] M. Chen, T. Wang, K. Ota, M. Dong, M. Zhao, and A. Liu, “Intelligent resource allocation management for vehicles network: An A3C learning approach,” *Computer Communications*, vol. 151, pp. 485–494, 2020.
- [104] Y. He, N. Zhao, and H. Yin, “Integrated networking, caching, and computing for connected vehicles: A deep reinforcement learning approach,” *IEEE Transactions on Vehicular Technology*, vol. 67, no. 1, pp. 44–55, 2017.
- [105] S. Nayak and R. Patgiri, “6G communication technology: A vision on intelligent healthcare,” *arXiv preprint arXiv:2005.07532*, 2020.
- [106] F. Al-Turjman, M. H. Nawaz, and U. D. Ulusar, “Intelligence in the Internet of medical things era: a systematic review of current and future trends,” *Computer Communications*, vol. 150, pp. 644–660, 2020.
- [107] Y. Siriwardhana, C. De Alwis, G. Gür, M. Ylianttila, and M. Liyanage, “The fight against the COVID-19 pandemic with 5G technologies,” *IEEE Engineering Management Review*, vol. 48, no. 3, pp. 72–84, 2020.
- [108] R. Gupta, U. Thakker, S. Tanwar, M. S. Obaidat, and K.-F. Hsiao, “BITS: A blockchain-driven intelligent scheme for telesurgery system,” in *2020 International Conference on Computer, Information and Telecommunication Systems (CITS)*. IEEE, 2020, pp. 1–5.
- [109] T. X. Tran, A. Hajisami, P. Pandey, and D. Pompili, “Collaborative mobile edge computing in 5G networks: New paradigms, scenarios, and challenges,” *Communications Magazine*, vol. 55, no. 4, pp. 54–61, 2017.
- [110] W. Shi and S. Dustdar, “The promise of edge computing,” *Computer*, vol. 49, no. 5, pp. 78–81, 2016.
- [111] A. A. Abdellatif, A. Mohamed, C. F. Chiasserini, M. Thili, and A. Erbad, “Edge computing for smart health: Context-aware approaches, opportunities, and challenges,” *IEEE Network*, vol. 33, no. 3, pp. 196–203, 2019.
- [112] M. Du, K. Wang, Y. Chen, X. Wang, and Y. Sun, “Big data privacy preserving in multi-access edge computing for heterogeneous Internet of Things,” *IEEE Communications Magazine*, vol. 56, no. 8, pp. 62–67, 2018.
- [113] L. Dang, M. Dong, K. Ota, J. Wu, J. Li, and G. Li, “Resource-efficient secure data sharing for information centric e-health system using fog computing,” in *2018 IEEE International Conference on Communications (ICC)*. IEEE, 2018, pp. 1–6.
- [114] R. Ullah, S. H. Ahmed, and B.-S. Kim, “Information-centric networking with edge computing for IoT: Research challenges and future directions,” *IEEE Access*, vol. 6, pp. 73 465–73 488, 2018.
- [115] X. Fang, S. Misra, G. Xue, and D. Yang, “Smart grid — the new and improved power grid: A survey,” *IEEE Communications Surveys & Tutorials*, vol. 14, no. 4, pp. 944–980, Dec. 2011.
- [116] M. Erol-Kantarci and H. T. Mouftah, “Energy-efficient information and communication infrastructures in the smart grid: A survey on interactions and open issues,” *IEEE Communications Surveys & Tutorials*, vol. 17, no. 1, pp. 179–197, Jul. 2014.
- [117] S. Bera, S. Misra, and J. J. P. C. Rodrigues, “Cloud computing applications for smart grid: A survey,” *IEEE Transactions on Parallel and Distributed Systems*, vol. 26, no. 5, pp. 1477–1494, May 2015.
- [118] U. Greveler, P. Glösekötterz, B. Justusy, and D. Loehr, “Multimedia content identification through smart meter power usage profiles,” in *Proceedings of the International Conference on Information and Knowledge Engineering (IKE)*. The Steering Committee of The World Congress in Computer Science, Computer, 2012.
- [119] O. Hamid, M. Barbarosou, P. Papageorgas, K. Prekas, and C.-T. Salame, “Automatic recognition of electric loads analyzing the characteristic parameters of the consumed electric power through a non-intrusive monitoring methodology,” *Energy Procedia*, vol. 119, pp. 742–751, 2017, International Conference on Technologies and Materials for Renewable Energy, Environment and Sustainability, TM-REES17, 21-24 April 2017, Beirut Lebanon.
- [120] C. Feng, Y. Wang, Q. Chen, Y. Ding, G. Strbac, and C. Kang, “Smart grid encounters edge computing: Opportunities and applications,” *Advances in Applied Energy*, vol. 1, p. 100006, Feb. 2021. [Online]. Available: <https://www.sciencedirect.com/science/article/pii/S2666792420300068>
- [121] F. Y. Okay and S. Ozdemir, “A fog computing based smart grid model,” in *2016 International Symposium on Networks, Computers and Communications (ISNCC)*, Yasmine Hammamet, Tunisia, May 2016.
- [122] N. Kumar, S. Zeadally, and J. J. P. C. Rodrigues, “Vehicular delay-tolerant networks for smart grid data management using mobile edge computing,” *IEEE Communications Magazine*, vol. 54, no. 10, pp. 60–66, Oct. 2016.
- [123] D. Grewe, M. Wagner, and H. Frey, “Icn-based open, distributed data market place for connected vehicles: Challenges and research directions,” in *2017 IEEE International Conference on Communications Workshops (ICC Workshops)*, Paris, France, 2017, pp. 265–270.
- [124] K. V. Katsaros, W. K. Chai, N. Wang, G. Pavlou, H. Bontius, and M. Paolone, “Information-centric networking for machine-to-machine data delivery: A case study in smart grid applications,” *IEEE Network*, vol. 28, no. 3, pp. 58–64, Jun. 2014.
- [125] Y. Huang, Y. Lu, F. Wang, X. Fan, J. Liu, and V. C. M. Leung, “An edge computing framework for real-time monitoring in smart grid,” in *2018 IEEE International Conference on Industrial Internet (ICII)*, Seattle, WA, Oct. 2018, pp. 99–108.
- [126] A. F. R. Trajano, A. A. M. de Sousa, E. B. Rodrigues, J. N. de Souza, A. de Castro Callado, and E. F. Coutinho, “Leveraging mobile edge computing on smart grids using LTE cellular networks,” in *2019 IEEE Symposium on Computers and Communications (ISCC)*, Barcelona, Spain, 2019.
- [127] F. Samie, L. Bauer, and J. Henkel, “Edge computing for smart grid: An overview on architectures and solutions,” *IoT for Smart Grids*, pp. 21–42, 2019.
- [128] M. Cosovic, A. Tsitsimelis, D. Vukobratovic, J. Matamoros, and C. Anton-Haro, “5G mobile cellular networks: Enabling distributed state estimation for smart grids,” *IEEE Communications Magazine*, vol. 55, no. 10, pp. 62–69, Oct. 2017.
- [129] Y. Cao, H. Song, O. Kaiwartya, B. Zhou, Y. Zhuang, Y. Cao, and X. Zhang, “Mobile edge computing for big-data-enabled electric vehicle charging,” *IEEE Communications Magazine*, vol. 56, no. 3, pp. 150–156, Mar. 2018.
- [130] B. Vieira and E. Poll, “A security protocol for information-centric networking in smart grids,” in *Proceedings of the First ACM Workshop on Smart Energy Grid Security*, ser. SEGS ’13. New York, NY, USA: Association for Computing Machinery, Nov. 2013, p. 1–10.

- [131] Y. Lu, M. Yue, and Z. Wu, "Content security over ICN based smart grid: A cryptographic solution," in *2021 IEEE Int. Conf. Parallel Distributed Processing with Applications, Big Data & Cloud Computing, Sustainable Computing & Communications, Social Computing & Networking (ISPA/BDCloud/SocialCom/SustainCom)*, New York City, NY, USA, 2021, pp. 785–791.
- [132] K. V. Katsaros, W. K. Chai, B. Vieira, and G. Pavlou, "Supporting smart electric vehicle charging with information-centric networking," in *10th International Conference on Heterogeneous Networking for Quality, Reliability, Security and Robustness*, Rhodes, Greece, Aug. 2014, pp. 174–179.
- [133] W. K. Chai, K. V. Katsaros, M. Strobbe, P. Romano, C. Ge, C. Develder, G. Pavlou, and N. Wang, "Enabling smart grid applications with ICN," in *Proceedings of the 2nd ACM Conference on Information-Centric Networking*, ser. ACM-ICN '15. New York, NY, USA: Association for Computing Machinery, Sep. 2015, p. 207–208.
- [134] K. Yu, M. Arifuzzaman, Z. Wen, D. Zhang, and T. Sato, "A key management scheme for secure communications of information centric advanced metering infrastructure in smart grid," *IEEE Transactions on Instrumentation and Measurement*, vol. 64, no. 8, pp. 2072–2085, Jun. 2015.
- [135] R. Tourani, S. Misra, T. Mick, S. Brahma, M. Biswal, and D. Ameme, "iCenS: An information-centric smart grid network architecture," in *2016 IEEE International Conference on Smart Grid Communications (SmartGridComm)*, Sydney, NSW, Australia, Nov. 2016, pp. 417–422.
- [136] K. Wang, J. Li, J. Wu, and G. Li, "QoS-predicted energy efficient routing for information-centric smart grid: A network calculus approach," *IEEE Access*, vol. 6, pp. 52 867–52 876, 2018.
- [137] M. O'Grady, D. Langton, and G. O'Hare, "Edge computing: A tractable model for smart agriculture?" *Artificial Intelligence in Agriculture*, vol. 3, pp. 42–51, 2019.
- [138] D. Mars, S. M. Gammar, A. Lahmadi, and L. A. Saidane, "Using information centric networking in Internet of Things: a survey," *Wireless Personal Communications*, vol. 105, no. 1, pp. 87–103, 2019.
- [139] P. Phupattanasin and S.-R. Tong, "Applying information-centric networking in today's agriculture," *Apcbee Procedia*, vol. 8, pp. 184–188, 2014.
- [140] G. C. Polyzos and N. Fotiou, "Building a reliable Internet of Things using information-centric networking," *Journal of Reliable Intelligent Environments*, vol. 1, no. 1, pp. 47–58, 2015.
- [141] Q.-Y. Zhang, X.-W. Wang, M. Huang, K.-Q. Li, and S. K. Das, "Software defined networking meets information centric networking: A survey," *IEEE Access*, vol. 6, pp. 39 547–39 563, 2018.
- [142] J. Xu, K. Ota, and M. Dong, "Energy efficient hybrid edge caching scheme for tactile internet in 5G," *IEEE Transactions on Green Communications and Networking*, vol. 3, no. 2, pp. 483–493, 2019.
- [143] R. Ravindran, A. Chakraborti, S. O. Amin, A. Azgin, and G. Wang, "Realizing ICN in 3GPP's 5G nextgen core architecture," *arXiv preprint arXiv:1711.02232*, 2017.
- [144] P. Porambage, J. Okwuibe, M. Liyanage, M. Ylianttila, and T. Taleb, "Survey on multi-access edge computing for Internet of Things realization," *IEEE Commun. Surveys Tuts.*, vol. 20, no. 4, pp. 2961–2991, 2018.
- [145] S. Kekki, W. Featherstone, Y. Fang, P. Kuure, A. Li, A. Ranjan, D. Purkayastha, F. Jiangping, D. Frydman, G. Verin, K.-W. Wen, K. Kim, R. Arora, A. Odgers, L. M. Contreras, and S. Scarpina, "MEC in 5G networks," *ETSI White Paper*, 2018.
- [146] D. Posch, B. Rainer, and H. Hellwagner, "Towards a context-aware forwarding plane in named data networking supporting QoS," *ACM SIGCOMM Computer Communication Review*, vol. 47, no. 1, pp. 4–14, 2017.
- [147] I. Araujo, A. Silva, A. Klautau, and N. Linder, "QoS in forwarding strategies for ICN: New algorithm and experimental evaluation," *Journal of Communication and Information Systems*, vol. 34, no. 1, pp. 275–286, 2019.
- [148] K. R. Koenig, K. S. Pasupathy, T. R. Hellmich, H. J. Hawthorne, V. P. Karalius, M. Sir, D. Das, H. A. Heaton, and D. M. Nestler, "Measuring sensitivity and precision of real-time location systems (RTLS): Definition, protocol and demonstration for clinical relevance," *Journal of Medical Systems*, vol. 45, no. 1, pp. 1–7, 2021.
- [149] A. Cavoukian, "Anonymous video analytics (AVA) technology and privacy," *White Paper, Information and Privacy Commissioner, Ontario, Canada (April 2011)*, 2011.
- [150] M. Aamir and S. M. A. Zaidi, "Denial-of-service in content centric (named data) networking: A tutorial and state-of-the-art survey," *Security and Communication Networks*, vol. 8, no. 11, pp. 2037–2059, 2015.
- [151] T. Nguyen, X. Marchal, G. Doyen, T. Cholez, and R. Cogranne, "Content poisoning in named data networking: Comprehensive characterization of real deployment," in *2017 IFIP/IEEE Symposium on Integrated Network and Service Management (IM)*. IEEE, 2017, pp. 72–80.
- [152] H. Im and D. Kim, "An overview of content poisoning in NDN: Attacks, countermeasures, and direction," *KSII Transactions on Internet and Information Systems (TIIS)*, vol. 14, no. 7, pp. 2904–2918, 2020.
- [153] H. Guo, X. Wang, K. Chang, and Y. Tian, "Exploiting path diversity for thwarting pollution attacks in named data networking," *IEEE Transactions on Information Forensics and Security*, vol. 11, no. 9, pp. 2077–2090, 2016.
- [154] D. Kutscher, S. Eum, K. Pentikousis, I. Psaras, D. Corujo, D. Saucez, T. Schmidt, and M. Waehlich, "Information-centric networking (ICN) research challenges," *Internet Research Task Force (IRTF)*, pp. 1–38, 2016.
- [155] M. Ion, J. Zhang, and E. M. Schooler, "Toward content-centric privacy in ICN: Attribute-based encryption and routing," in *Proceedings of the 3rd ACM SIGCOMM workshop on Information-centric networking*, 2013, pp. 39–40.
- [156] A. Mohaisen, X. Zhang, M. Schuchard, H. Xie, and Y. Kim, "Protecting access privacy of cached contents in information centric networks," in *Proceedings of the 8th ACM SIGSAC symposium on Information, computer and communications security*, 2013, pp. 173–178.
- [157] C. Xu, L. Zhang, L. Zhu, C. Zhang, X. Du, M. Guizani, and K. Sharif, "Aggregate in my way: Privacy-preserving data aggregation without trusted authority in ICN," *Future Generation Computer Systems*, vol. 111, pp. 107–116, 2020.
- [158] Q. Lyu, Y. Qi, X. Zhang, H. Liu, Q. Wang, and N. Zheng, "SBAC: A secure blockchain-based access control framework for information-centric networking," *Journal of Network and Computer Applications*, vol. 149, p. 102444, 2020.
- [159] S. S. Adhatarao, J. Chen, M. Arumathurai, X. Fu, and K. Ramakrishnan, "Comparison of naming schema in ICN," in *2016 IEEE International Symposium on Local and Metropolitan Area Networks (LANMAN)*. IEEE, 2016, pp. 1–6.
- [160] S. Arshad, B. Shahzaad, M. A. Azam, J. Loo, S. H. Ahmed, and S. Aslam, "Hierarchical and flat-based hybrid naming scheme in content-centric networks of things," *IEEE Internet of Things Journal*, vol. 5, no. 2, pp. 1070–1080, 2018.
- [161] B. Nour, K. Sharif, F. Li, H. Mounsla, and Y. Liu, "A unified hybrid information-centric naming scheme for IoT applications," *Computer Communications*, vol. 150, pp. 103–114, 2020.
- [162] S. Arshad, M. A. Azam, S. H. Ahmed, and J. Loo, "Towards information-centric networking (ICN) naming for Internet of Things (IoT) the case of smart campus," in *Proceedings of the International Conference on Future Networks and Distributed Systems*, 2017, pp. 1–6.
- [163] S. H. Bouk, S. H. Ahmed, and D. Kim, "Hierarchical and hash based naming with compact trie name management scheme for vehicular content centric networks," *Computer Communications*, vol. 71, pp. 73–83, 2015.
- [164] M. Amadeo, C. Campolo, A. Molinaro, and G. Ruggeri, "IoT data processing at the edge with named data networking," in *European Wireless 2018; 24th European Wireless Conference*. VDE, 2018, pp. 1–6.
- [165] A. Azgin, R. Ravindran, A. Chakraborti, and G.-Q. Wang, "Seamless producer mobility as a service in information centric networks," in *Proceedings of the 3rd ACM Conference on Information-Centric Networking*, 2016, pp. 243–248.
- [166] S. Adhatarao, M. Arumathurai, D. Kutscher, and X. Fu, "Nemio: Network mobility in icn," in *International Conference on Communication Systems and Networks*. Springer, 2018, pp. 220–244.
- [167] M. Hussaini, M. A. Naeem, B.-S. Kim, and I. S. Majjama'a, "Efficient producer mobility management model in information-centric networking," *IEEE Access*, vol. 7, pp. 42 032–42 051, 2019.
- [168] L. Nkenyereye, J. Y. Hwang, Q.-V. Pham, and J. S. Song, "Virtual IoT service slice functions for multi-access edge computing platform," *IEEE Internet of Things Journal*, vol. 8, no. 14, pp. 11 233–11 248, 2021.
- [169] S. Wijethilaka and M. Liyanage, "Realizing internet of things with network slicing: Opportunities and challenges," in *2021 IEEE 18th Annual Consumer Communications & Networking Conference (CCNC)*. IEEE, 2021, pp. 1–6.
- [170] A. Chakraborti, S. O. Amin, A. Azgin, S. Misra, and R. Ravindran, "Using ICN slicing framework to build an IoT edge network," in *ACM Conference on Information-Centric Networking 2018*, 2018, pp. 1–2.

- [171] ETSI, "Multi-access edge computing (MEC); MEC 5G integration," ETSI, Group Report MEC 031 V2.1.1, Oct. 2020. [Online]. Available: https://www.etsi.org/deliver/etsi_gr/MEC/001_099/031/02.01.01_60/gr_MEC031v020101p.pdf
- [172] —, "Multi-access edge computing (MEC); support for network slicing," ETSI, Group Report MEC 024 V2.1.1, Nov. 2019. [Online]. Available: https://www.etsi.org/deliver/etsi_gr/MEC/001_099/024/02.01.01_60/gr_MEC024v020101p.pdf
- [173] C. Gündoğan, T. C. Schmidt, M. Wählisch, C. Scherb, C. Marxer, and C. Tschudin, "ICN adaptation to LoWPAN networks (ICN LoWPAN)," IETF, Internet-Draft draft-irtf-icnrg-icnlowpan-10, Feb. 2021, work in Progress. [Online]. Available: <https://datatracker.ietf.org/doc/html/draft-irtf-icnrg-icnlowpan-10>
- [174] J. Hong, T. You, and V. Kafle, "Architectural considerations of ICN using name resolution service," IETF, Internet-Draft draft-irtf-icnrg-nrsarch-considerations-06, Feb. 2021, work in Progress. [Online]. Available: <https://datatracker.ietf.org/doc/html/draft-irtf-icnrg-nrsarch-considerations-06>
- [175] R. Ravindran, P. Suthar, D. Trossen, C. Wang, and G. White, "Enabling ICN in 3GPP's 5G NextGen core architecture," IETF, Internet-Draft draft-irtf-icnrg-5gc-icn-04, Jan. 2021, work in Progress. [Online]. Available: <https://datatracker.ietf.org/doc/html/draft-irtf-icnrg-5gc-icn-04>
- [176] H. Asaeda, A. Ooka, and X. Shao, "CCNinfo: Discovering content and network information in content-centric networks," IETF, Internet-Draft draft-irtf-icnrg-ccninfo-10, Apr. 2022, work in Progress. [Online]. Available: <https://datatracker.ietf.org/doc/draft-irtf-icnrg-ccninfo/10/>
- [177] D. R. Oran, "Considerations in the development of a QoS architecture for CCNx-like ICN protocols," IETF, Internet-Draft draft-iran-icnrg-qosarch-06, Nov. 2020, work in Progress. [Online]. Available: <https://datatracker.ietf.org/doc/html/draft-iran-icnrg-qosarch-06>
- [178] J. Hong, T. You, L. Dong, C. Westphal, and B. Ohlman, "Design considerations for name resolution service in ICN," IETF, Internet-Draft draft-irtf-icnrg-nrs-requirements-04, Oct. 2020, work in Progress. [Online]. Available: <https://datatracker.ietf.org/doc/html/draft-irtf-icnrg-nrs-requirements-04>
- [179] A. Rahman, D. Trossen, D. Kutscher, and R. Ravindran, "Deployment considerations for information-centric networking (ICN)," IETF, Request for Comments (RFC) 8763, Apr. 2020. [Online]. Available: <https://rfc-editor.org/rfc/rfc8763.txt>
- [180] K. Pentikousis, B. Ohlman, D. Corujo, G. Boggia, G. Tyson, E. B. Davies, A. Molinaro, and S. Eum, "Information-centric networking: Baseline scenarios," IETF, Request for Comments (RFC) 7476, Mar. 2015. [Online]. Available: <https://rfc-editor.org/rfc/rfc7476.txt>
- [181] ITU-T, "Architecture of ICN-enabled edge network in IMT-2020," ITU-T, Recommendation Y.3076, Sep. 2020. [Online]. Available: <http://www.itu.int/rec/T-REC-Y.3076-202009-I>
- [182] ITU-T SG-13, "Requirements and architecture of information centric core network," ITU-T SG-13 Recommendation (under study), 2019, accessed on 03.14.2021. [Online]. Available: https://www.itu.int/itu-t/workprog/wp_item.aspx?isn=16338
- [183] —, "Framework of locally enhanced name mapping and resolution for information centric networking in IMT-2020," ITU-T SG-13 Recommendation (under study), 2019, accessed on 03.14.2021. [Online]. Available: https://www.itu.int/itu-t/workprog/wp_item.aspx?isn=15179
- [184] ITU-T, "Requirements and capabilities of information-centric networking routing and forwarding based on control and user plane separation in IMT-2020," ITU-T, Recommendation Y.3075, Sep. 2020. [Online]. Available: <http://www.itu.int/rec/T-REC-Y.3075-202009-I>
- [185] ETSI, "Multi-access edge computing (MEC); radio network information API," ETSI, Group Specification MEC 012 V2.2.1, Feb. 2022. [Online]. Available: https://www.etsi.org/deliver/etsi_gs/MEC/001_099/012/02.02.01_60/gs_MEC012v020201p.pdf
- [186] —, "Multi-access edge computing (MEC); location API," ETSI, Group Specification MEC 013 V2.2.1, Jan. 2022. [Online]. Available: https://www.etsi.org/deliver/etsi_gs/MEC/001_099/013/02.02.01_60/gs_MEC013v020201p.pdf
- [187] —, "Multi-access edge computing (MEC); UE identity APIs," ETSI, Group Specification MEC 014 V2.1.1, Mar. 2021. [Online]. Available: https://www.etsi.org/deliver/etsi_gs/MEC/001_099/014/02.01.01_60/gs_MEC014v020101p.pdf
- [188] —, "Multi-access edge computing (MEC); traffic management APIs," ETSI, Group Specification MEC 015 V2.1.1, Jun. 2020. [Online]. Available: https://www.etsi.org/deliver/etsi_gs/MEC/001_099/015/02.01.01_60/gs_mec015v020101p.pdf
- [189] —, "Multi-access edge computing (MEC); application mobility service API," ETSI, Group Specification MEC 021 V2.1.1, Jan. 2020. [Online]. Available: https://www.etsi.org/deliver/etsi_gs/MEC/001_099/021/02.01.01_60/gs_MEC021v020101p.pdf
- [190] —, "Multi-access edge computing (MEC); WLAN information API," ETSI, Group Specification MEC 028 V2.1.1, Jun. 2020. [Online]. Available: https://www.etsi.org/deliver/etsi_gs/MEC/001_099/028/02.01.01_60/gs_MEC028v020101p.pdf
- [191] —, "Multi-access edge computing (MEC); V2X information service API," ETSI, Group Specification MEC 030 V2.1.1, Apr. 2020. [Online]. Available: https://www.etsi.org/deliver/etsi_gs/MEC/001_099/030/02.01.01_60/gs_MEC030v020101p.pdf
- [192] —, "Next generation protocols (NGP); scenario definitions," ETSI, Group Specification NGP 001 V1.3.1, Jan. 2019. [Online]. Available: https://www.etsi.org/deliver/etsi_gs/NGP/001_099/001/01.03.01_60/gs_ngp001v010301p.pdf
- [193] "IETF ICN research group (ICNrg)," Accessed: Feb. 26, 2021. [Online]. Available: <https://datatracker.ietf.org/rg/icnrg/documents>
- [194] D. Kutscher, S. Eum, K. Pentikousis, I. Psaras, D. Corujo, D. Saucez, T. C. Schmidt, and M. Wählisch, "Information-centric networking (ICN) research challenges," IETF, Request for Comments (RFC) 7927, Jul. 2016. [Online]. Available: <https://rfc-editor.org/rfc/rfc7927.txt>
- [195] K. Pentikousis, B. Ohlman, E. B. Davies, S. Spirout, and G. Boggia, "Information-centric networking: Evaluation and security considerations," IETF, Request for Comments (RFC) 7954, Sep. 2016. [Online]. Available: <https://rfc-editor.org/rfc/rfc7954.txt>
- [196] J. Seedorf, M. Arumathurai, A. Tagami, K. Ramakrishnan, and N. Blefari-Melazzi, "Research directions for using information-centric networking (ICN) in disaster scenarios," IETF, Request for Comments (RFC) 8884, Oct. 2020. [Online]. Available: <https://rfc-editor.org/rfc/rfc8884.txt>
- [197] B. Wisingh, C. A. Wood, A. Afanasyev, L. Zhang, D. R. Oran, and C. Tschudin, "Information-centric networking (ICN): Content-centric networking (CCNx) and named data networking (NDN) terminology," IETF, Request for Comments (RFC) 8793, Jun. 2020. [Online]. Available: <https://rfc-editor.org/rfc/rfc8793.txt>
- [198] M. Mosko, I. Solis, and C. A. Wood, "Content-centric networking (CCNx) messages in TLV format," IETF, Request for Comments (RFC) 8609, Jul. 2019. [Online]. Available: <https://rfc-editor.org/rfc/rfc8609.txt>
- [199] —, "Content-centric networking (CCNx) semantics," IETF, Request for Comments (RFC) 8569, Jul. 2019. [Online]. Available: <https://rfc-editor.org/rfc/rfc8569.txt>
- [200] ITU-T, "ITU-T Study Group 13," Accessed: Feb. 26, 2021. [Online]. Available: <https://www.itu.int/en/ITU-T/about/groups/Pages/sg13.aspx>
- [201] —, "Future networks: Objectives and design goals," ITU-T, Recommendation Y.3001, May. 2011. [Online]. Available: <https://www.itu.int/rec/T-REC-Y.3001-201105-I>
- [202] —, "Framework of data aware networking for future networks," ITU-T, Recommendation Y.3033, Jan. 2014. [Online]. Available: <https://www.itu.int/rec/T-REC-Y.3033-201401-I>
- [203] —, "Data aware networking (information centric networking) - requirements and capabilities," ITU-T, Recommendation Y.3071, Mar. 2017. [Online]. Available: <https://www.itu.int/rec/T-REC-Y.3071-201703-I/>
- [204] ITU-T SG-13, "Requirements and capabilities of transport layer for icn in imt-2020," ITU-T SG-13 Recommendation (under study), 2020, accessed on 03.14.2021. [Online]. Available: https://www.itu.int/itu-t/workprog/wp_item.aspx?isn=14915
- [205] ITU-T, "Requirements and capabilities of name mapping and resolution for information-centric networking in IMT-2020," ITU-T, Recommendation Y.3072, Apr. 2019. [Online]. Available: <http://www.itu.int/rec/T-REC-Y.3072-201904-I>
- [206] —, "Framework for service function chaining in information-centric networking," ITU-T, Recommendation Y.3073, Aug. 2019. [Online]. Available: <https://www.itu.int/rec/T-REC-Y.3073-201908-I>
- [207] —, "Framework for interworking of heterogeneous application domain connected objects through information-centric networking in IMT-2020," ITU-T, Recommendation Y.3077, Sep. 2021. [Online]. Available: <https://www.itu.int/rec/T-REC-Y.3077-202109-I>
- [208] —, "Information centric networking for IMT-2020 and beyond - Requirements and capabilities of data object segmentation," ITU-T, Recommendation Y.3078, Feb. 2022. [Online]. Available: <https://www.itu.int/rec/T-REC-Y.3078-202202-I>
- [209] 3GPP, "3rd generation partnership project (3GPP)," Accessed: Feb. 26, 2021. [Online]. Available: <https://www.3gpp.org/>

- [210] "System architecture for the 5G system (5GS)," 3GPP, Technical Specification 23.501 (Release 15), Dec. 2017. [Online]. Available: <https://www.3gpp.org/DynaReport/23501.htm>
- [211] "Study on enhancement of support for edge computing in 5G core network (5GC)," 3GPP, Technical Report 23.748 (Release 17), Apr. 2019. [Online]. Available: <https://www.3gpp.org/DynaReport/23748.htm>
- [212] "Study on security aspects of enhancement of support for edge computing in 5G core (5GC)," 3GPP, Technical Report 33.839 (Release 17), Jul. 2020. [Online]. Available: <https://www.3gpp.org/DynaReport/33839.htm>
- [213] "5G media streaming (5GMS); architecture extensions," 3GPP, Technical Report 26.803 (Release 17), Mar. 2020. [Online]. Available: <https://www.3gpp.org/DynaReport/26803.htm>
- [214] "Study on enhancements of edge computing management," 3GPP, Technical Report 28.814 (Release 17), Apr. 2020. [Online]. Available: <https://www.3gpp.org/DynaReport/28814.htm>
- [215] "Study on alignment with ETSI mobile edge computing (MEC) for edge computing management," 3GPP, Technical Report 28.903 (Release 18), Mar. 2022. [Online]. Available: <https://portal.3gpp.org/desktopmodules/Specifications/SpecificationDetails.aspx?specificationId=4032>
- [216] "Study on enhanced application architecture for enabling edge applications," 3GPP, Technical Report 23.700-98 (Release 18), Jun. 2021. [Online]. Available: <https://portal.3gpp.org/desktopmodules/Specifications/SpecificationDetails.aspx?specificationId=3920>
- [217] "5G system enhancements for edge computing; phase 2," 3GPP, Technical Report 23.700-48 (Release 18), Jan. 2022. [Online]. Available: <https://portal.3gpp.org/desktopmodules/Specifications/SpecificationDetails.aspx?specificationId=3999>
- [218] "Study on security enhancement of support for edge computing; phase 2," 3GPP, Technical Report 33.739 (Release 18), Apr. 2022. [Online]. Available: <https://portal.3gpp.org/desktopmodules/Specifications/SpecificationDetails.aspx?specificationId=4050>
- [219] H. Khelifi, S. Luo, B. Nour, A. Sellami, H. Mounгла, S. H. Ahmed, and M. Guizani, "Bringing deep learning at the edge of information-centric internet of things," *IEEE Communications Letters*, vol. 23, no. 1, pp. 52–55, 2018.
- [220] T. Elgamal, A. Sandur, P. Nguyen, K. Nahrstedt, and G. Agha, "DROPLET: Distributed operator placement for IoT applications spanning edge and cloud resources," in *2018 IEEE 11th International Conference on Cloud Computing (CLOUD)*, San Francisco, CA, USA, Jul. 2018.
- [221] H. Li, K. Ota, and M. Dong, "Learning IoT in edge: Deep learning for the internet of things with edge computing," *IEEE Network*, vol. 32, no. 1, pp. 96–101, Jan. 2018.
- [222] Y. He, F. R. Yu, N. Zhao, V. C. M. Leung, and H. Yin, "Software-defined networks with mobile edge computing and caching for smart cities: A big data deep reinforcement learning approach," *IEEE Communications Magazine*, vol. 55, no. 12, pp. 31–37, Dec. 2017.
- [223] M. Huang, A. Liu, N. N. Xiong, T. Wang, and A. V. Vasilakos, "An effective service-oriented networking management architecture for 5G-enabled internet of things," *Computer networks*, vol. 173, p. 107208, May 2020.
- [224] R. Zhang, F. R. Yu, J. Liu, T. Huang, and Y. Liu, "Deep reinforcement learning (DRL)-based device-to-device (D2D) caching with blockchain and mobile edge computing," *IEEE Transactions on Wireless Communications*, vol. 19, no. 10, pp. 6469–6485, 2020.
- [225] X. Lin, J. Wu, S. Mumtaz, S. Garg, J. Li, and M. Guizani, "Blockchain-based on-demand computing resource trading in IoV-assisted smart city," *IEEE Transactions on Emerging Topics in Computing*, 2020.
- [226] M. Liyanage, J. Salo, A. Braeken, T. Kumar, S. Seneviratne, and M. Ylianttila, "5G privacy: Scenarios and solutions," in *2018 IEEE 5G World Forum (5GWF)*. IEEE, 2018, pp. 197–203.
- [227] J. Xu and J. Yao, "Exploiting physical-layer security for multiuser multicarrier computation offloading," *IEEE Wireless Communications Letters*, vol. 8, no. 1, pp. 9–12, 2018.
- [228] D. C. Nguyen, P. N. Pathirana, M. Ding, and A. Seneviratne, "Integration of blockchain and cloud of things: Architecture, applications and challenges," *IEEE Communications Surveys & Tutorials*, vol. 22, no. 4, pp. 2521–2549, 2020.
- [229] H. Li, K. Wang, T. Miyazaki, C. Xu, S. Guo, and Y. Sun, "Trust-enhanced content delivery in blockchain-based information-centric networking," *IEEE Network*, vol. 33, no. 5, pp. 183–189, 2019.
- [230] N.-N. Dao, Q.-V. Pham, N. H. Tu, T. T. Thanh, V. N. Q. Bao, D. S. Lakew, and S. Cho, "Survey on aerial radio access networks: Toward

- a comprehensive 6G access infrastructure," *IEEE Communications Surveys and Tutorials Computing*, vol. 23, no. 2, pp. 1193–1225, 2021.
- [231] X. Wang, H. Liy, W. Yao, T. Lany, and Q. Wu, "Content delivery for high-speed railway via integrated terrestrial-satellite networks," in *2020 IEEE Wireless Communications and Networking Conference (WCNC)*. IEEE, 2020, pp. 1–6.
- [232] C. Xu, P. Zhang, S. Jia, M. Wang, and G.-M. Muntean, "Video streaming in content-centric mobile networks: Challenges and solutions," *IEEE Wireless Communications*, vol. 24, no. 5, pp. 157–165, 2017.
- [233] F. Wu, W. Yang, J. Ren, F. Lyu, X. Ding, and Y. Zhang, "Adaptive video streaming using dynamic NDN multicast in WLAN," in *IEEE INFOCOM 2020-IEEE Conference on Computer Communications Workshops (INFOCOM WKSHPS)*. IEEE, 2020, pp. 97–102.
- [234] S. D. A. Shah, M. A. Gregory, S. Li, and R. D. R. Fontes, "SDN enhanced multi-access edge computing (MEC) for E2E mobility and QoS management," *IEEE Access*, vol. 8, pp. 77 459–77 469, 2020.



Gürkan Gür is a senior lecturer at Institute of Applied Information Technology (InIT), Zurich University of Applied Sciences (ZHAW), Switzerland. He received his B.S. degree in electrical engineering in 2001 and Ph.D. degree in computer engineering in 2013 from Bogazici University. He is a senior member of IEEE and a member of ACM. His research interests include Future Internet, information security, next-generation wireless networks and ICN.



Anshuman Kalla is working as Professor at CGPIT, Uka Tarsadia University, India. Dr. Kalla has more than twelve years of teaching and research experience. He graduated as Engineer from Govt. Engineering College Bikaner in 2004. He has his Master of Science in Telecommunications and Wireless Networking from ISEP, Paris, France in 2008 and another Master from the University of Nice Sophia Antipolis, France in 2011. He obtained Ph.D. degree in 2017. Dr. Kalla has delivered invited sessions and talks during various Short Term Courses, Faculty Development Programs, Workshops, and Conferences. His area of interest includes Blockchain, Next Generation Networks - 5G & 6G, Internet of Things (IoT), Information Centric Networking (ICN), and Software Defined Networking (SDN). For more info: <https://sites.google.com/site/kallanshuman/>



Chamitha de Alwis (Senior Member, IEEE) received his B.Sc. (First Class Honours) in Electronic and Telecommunication Engineering from the University of Moratuwa, Sri Lanka. He obtained his Ph.D. in Electronic Engineering from the University of Surrey, United Kingdom. He is currently working as a Senior Lecturer/Head of Department in the Department of Electrical and Electronic Engineering, University of Sri Jayewardenepura, Sri Lanka. His main research interests include network security, 5G/6G, blockchain and IoT.



Quoc-Viet Pham (M'18) received the B.S. degree in electronics and telecommunications engineering from the Hanoi University of Science and Technology, Vietnam, in 2013, and the Ph.D. degree in telecommunications engineering from Inje University, Republic of Korea, in 2017. He has been a Research Professor with Pusan National University, Republic of Korea, since Feb. 2020.

He is specialized in applying convex optimization, game theory, and machine learning to analyze and optimize edge computing and future wireless communications. He has been granted the Korea NRF Funding for outstanding young researchers for the term 2019–2024. He is an editor of Journal of Network and Computer Applications (Elsevier), Scientific Reports (Nature), and Frontiers in Communications and Networks, and a lead guest editor of the IEEE Internet of Things Journal. He was also the recipient of the Best Ph.D. Dissertation Award in engineering from Inje University in 2017, the Top Reviewer Award from the IEEE Transactions on Vehicular Technology in 2020 and the golden globe award 2021 from the Ministry of Science and Technology (Vietnam).



Pawani Porambage Pawani Porambage is a post-doctoral researcher at the Centre for Wireless Communications, University of Oulu, Finland. She received her doctoral degree on Communications Engineering from University of Oulu, Finland in 2018. She obtained MSc and BSc degrees respectively from University of Nice Sophia-Anipolis, France (2012) and University of Moratuwa, Sri Lanka (2010). Her main research interests include lightweight security protocols, blockchain, security and privacy on IoT and MEC, Network Slicing and

Wireless Sensor Networks.



Khac-Hoang Ngo (M'20) received the B.Eng. degree (Hons.) in electronics and telecommunications from University of Engineering and Technology, Vietnam National University, Hanoi, Vietnam, in 2014; and the M.Sc. degree (Hons.) and Ph.D. degree in wireless communications from Centrale-Supélec, Paris-Saclay University, France, in 2016 and 2020, respectively.

He is currently a Postdoctoral Researcher at Communication Systems Group, Department of Electrical Engineering, Chalmers University of Technology, Sweden. He is also an Adjunct Lecturer at Advanced Institute of Engineering and Technology (AVITECH), University of Engineering and Technology, Vietnam National University Hanoi, Vietnam. His research interests include wireless communications and information theory, with an emphasis on MIMO, noncoherent communications, edge computing, massive random access, coded caching, and network coding.



Madhusanka Liyanage (Senior Member, IEEE) received his B.Sc. degree (First Class Honours) in electronics and telecommunication engineering from the University of Moratuwa, Moratuwa, Sri Lanka, in 2009, the M.Eng. degree from the Asian Institute of Technology, Bangkok, Thailand, in 2011, the M.Sc. degree from the University of Nice Sophia Antipolis, Nice, France, in 2011, and the Doctor of Technology degree in communication engineering from the University of Oulu, Oulu, Finland, in 2016. He is currently an assistant professor/Ad

Astra Fellow at School of Computer Science, University College Dublin, Ireland. He is also acting as an adjunct Professor at the Center for Wireless Communications, University of Oulu, Finland. He was also a recipient of prestigious Marie Skłodowska-Curie Actions Individual Fellowship during 2018-2020. During 2015-2018, he has been a Visiting Research Fellow at the CSIRO, Australia, the Infolabs21, Lancaster University, U.K., Computer Science and Engineering, The University of New South Wales, Australia, School of IT, University of Sydney, Australia, LIP6, Sorbonne University, France and Computer Science and Engineering, The University of Oxford, U.K. He is also a senior member of IEEE. In 2020, he has received "2020 IEEE ComSoc Outstanding Young Researcher" award by IEEE ComSoc EMEA. His research interests are 5G/6G, SDN, IoT, Blockchain, MEC, mobile and virtual network security. More info: www.madhusanka.com