



Network-Level Optimal Control for Public Bus Operation

Downloaded from: <https://research.chalmers.se>, 2026-04-04 05:00 UTC

Citation for the original published paper (version of record):

Varga, B., Peni, T., Kulcsár, B. et al (2020). Network-Level Optimal Control for Public Bus Operation. IFAC-PapersOnLine, 53(2): 15003-15010. <http://dx.doi.org/10.1016/j.ifacol.2020.12.1999>

N.B. When citing this work, cite the original published paper.

Network-level optimal control for public bus operation

Balázs Varga* Tamás Péni** Balázs Kulcsár***
Tamás Tettamanti*

* *Budapest University of Technology and Economics, Faculty of Transportation Engineering and Vehicle Engineering, Department of Control for Transportation and Vehicle Systems, Hungary, H-1111, Budapest, Műegyetem rkp. 3. (e-mail: varga.balazs@mail.bme.hu, tettamanti@mail.bme.hu)*

** *Institute for Computer Science and Control (SZTAKI), Hungary, H-1111, Budapest. Kende u. 13-17. (e-mail: peni.tamas@sztaki.mta.hu)*

*** *Department of Electrical Engineering, Chalmers University of Technology, Hörsalsvägen 9-11, SE-412-96, Gothenburg, Sweden, (e-mail: kulcsar@chalmers.se)*

Abstract: The paper presents modeling, control and analysis of an urban public transport network. First, a centralized system description is given, built up from the dynamics of individual buses and bus stops. Aiming to minimize three conflicting goals (equidistant headways, timetable adherence, and minimizing passenger waiting times), a reference tracking model predictive controller is formulated based on the piecewise-affine system model. The closed-loop system is analyzed with three methods. Numerical simulations on a simple experimental network showed that the temporal evolution of headways and passenger numbers could maintain their periodicity with the help of velocity control. With the help of randomized simulation scenarios, sensitivity of the system is analyzed. Finally, infeasible regions for the bus network control was sought using by formulating an explicit model predictive controller.

Copyright © 2020 The Authors. This is an open access article under the CC BY-NC-ND license (<http://creativecommons.org/licenses/by-nc-nd/4.0>)

Keywords: Urban systems, Public transport, Centralised control, Model predictive control, Piecewise-affine systems, Scenario based methods, Set theory

1. INTRODUCTION

In busy urban areas public transport networks cannot operate without supervision. The system is inherently unstable since transit lines are subject to travel time and passenger demand variability. This instability leads to bus bunching phenomena, first described in Newell and Potts (1964). In metropolitan areas bus lines are often intertwined, public transport buses can merge and travel on common routes or split, therefore service disruption on one line might propagate to the whole network. This propagation has not been analyzed earlier. In addition, corridors served by multiple bus lines mean higher passenger demand and higher frequency of buses, both stimulating bus bunching.

Due to bunching the periodicity of arrivals fails and homogeneous service cannot be maintained (Sorratini et al., 2008). Bus bunching has a well-established literature and several authors proposed different methods to overcome its adverse effect. In Daganzo and Pilachowski (2011) algorithms are developed to control the headways of consecutive buses. Bus bunching was mitigated by bus holding control in Wu et al. (2017). Ampountolas and Kring (2015) proposed a cooperative control algorithm for buses to balance headways. Multi-objective, passenger demand-driven public transport receives increasing interest recently. In

Xuan et al. (2011), optimal control algorithms were considered taking into account both headway and timetable keeping. In Varga et al. (2018a), both bus bunching and timetable adherence are dealt with model predictive control (MPC). The above works deal with bus bunching focusing on single bus lines. Recently, authors turned towards modeling and controlling the public transport bus network as a whole. A coordinated multiline bus holding strategy was formulated and network sensitivity analysis was carried out by Laskaris et al. (2018). The network layout, link lengths and passenger demand have significant effect on the network performance. In Schmöcker et al. (2016) the effect of overtaking on a corridor served by two lines was studied in comparison to bus holding. The paper concludes that the holding strategy is an additional source of delay to the system.

This work focuses on a public transport network in a centralized way. The first contribution of the paper is formulating a speed advisory control for every bus in the public transport network. The model attempts to minimize passenger wait times and ensure headway adherence while taking dwell times and external traffic into account. The speed advisory system assumes highly automated or autonomous vehicles where velocity control can be realized. The controller design is based on an NP-hard mixed

integer optimization. Although control design for high-dimensional mixed-integer systems is well-established, systematic analysis techniques for such systems are limited. The second contribution of the paper is an attempt to analyze the feasibility¹ and closed-loop performance with various methods: a) in-depth analysis through simulation, b) random sampling (Campi et al., 2009) and c) feasibility analysis via set theory (Borrelli, 2003).

The remainder of the paper is structured as follows. In Section 2 the control oriented model is formulated: a dynamical model is written for the longitudinal dynamics of public transport buses and the number of passengers waiting at bus stops are modeled. The two models (bus dynamics and bus stop dynamics) are recast into one network model. Then, in Section 3 the model predictive controller design is presented. In Section 4 the bus fleet control algorithm is demonstrated via simulation and analyzed with the help of the random sampling and set theory. Finally, Section 5 concludes the findings of the paper.

2. BUS NETWORK MODEL

This section discusses the control oriented discrete-time representation for urban bus networks. First, the dynamical models of individual buses are formulated. Then, a nonlinear system model for passenger numbers at bus stops is given. The two models are then combined into a network bus network model. The reference trajectory generation for control purposes is discussed in a separate subsection.

2.1 Bus dynamics model

The bus network bunching model is originated from the longitudinal dynamics of a single bus. The position $x_i(k)$ and velocity $v_i(k)$ of one vehicle (with index $i = 1, 2, \dots, M_B$) at time step k is formulated as a linear model by discrete-time difference equations:

$$x_i(k+1) = x_i(k) + v_i(k)\Delta t, \quad (1)$$

$$v_i(k+1) = v_i(k) + \frac{\Delta t}{\tau}((1-\beta)(v_{des,i}(k) - v_{dist,i}(k)) - v_i(k)), \quad (2)$$

over the time period of $[k\Delta t, (k+1)\Delta t]$ with Δt being the discrete time-step length, and $k = 1, 2, 3, \dots$ the discrete time-step index. The acceleration is modeled with a linear relaxation term where $v_{des,i}(k)$ denotes the desired velocity (i.e. velocity setpoint) of the vehicle. τ is a model parameter capturing the sensitivity of drivers to the change of their desired velocity. According to Helbing and Tilch (1998), τ shall be calibrated between 1.25 s and 2.5 s. Too small or high values would result in unrealistic acceleration or deceleration towards the desired velocity.

An additive error structure is proposed to include the traffic disturbance. The surrounding traffic imposes velocity $v_{dist,i}(k)$ on the controlled vehicle. This disturbance is included through a relaxation parameter $\beta \in [0, 1]$. The value of the disturbance is assumed to be known from traffic flow measurements.

¹ Under feasibility we mean the existence of a control input that satisfies all the constraints of the optimization (Stephen Boyd, 2019).

In addition, two (timetable- and headway) references tracking objectives are introduced:

Timetable tracking: define an idealized “optimal” trajectory based on the bus schedule and idealized dwell times $x_{tt,i}(k)$ for bus i . This reference term takes into account the varying headways due to merging and splitting bus lines. The timetable tracking reference can be written as follows:

$$z_{tt,i}(k) = x_i(k) - x_{tt,i}(k). \quad (3)$$

Headway tracking: this objective aims to eliminate the bus bunching effect. The headway reference trajectory is the past trajectory of the leading bus shifted by one headway time ahead: $x_{hw,i}(k) = x_{i-1}(k - T_{hw,i}(x_i)\Delta t)$. This relation indirectly couples vehicles in the bus network. If the bus follows this trajectory, equidistant headways are guaranteed in an insensitive way to the actual velocity of the leading bus. If the actual time headway between two consecutive buses is larger than the prediction horizon, the reference trajectory $x_{hw,i}(k)$ is known for every time iteration. The leading bus has already traveled on that trajectory so this information exists, $T_{hw,i}\Delta t > N$). In addition, the product $T_{hw,i}(x_i)\Delta t$ shall be an integer number as it is subtracted from the discrete time step index k .

$$\begin{aligned} z_{hw,i}(k) &= x_i(k) - x_{i-1}(k - T_{hw,i}(x_i)\Delta t) \\ &= x_i - x_{hw,i}(k). \end{aligned} \quad (4)$$

2.2 Bus stop dynamics

Bus stops are characterized by the number of passengers $p_j(k)$ waiting at them. In the proposed model passengers arrive at stop $j = 1, 2, \dots, M_S$ with known arrival rate α_j based on Poisson distribution. In addition, a boarding rate (passenger / time-step) is introduced with λ_j (Transportation Research Board, 2016).

$$p_j(k+1) = p_j(k) + \alpha_j(k) - \lambda_j \xi_j(k). \quad (5)$$

The variable $\xi_j(k)$ denotes ongoing passenger exchange. This variable will play a key role in formulating the network model as a hybrid dynamical system.

For a network level model, let's define sub-indexes $l = 1, 2, \dots, M_L$ denoting one public transport bus line, e.g. bus i_l belongs to line l on which stop j_l is. Next, define an integer variable $\xi_j(k) \in [0, 1, \dots, M_B]$ denoting that a bus is at stop j_l performing passenger exchange. This is true if two conditions are fulfilled: the bus is at the stop x_{stop,j_l} and there are passengers at the stop. It has to be checked for every bus and for every stop on every line if there are passengers waiting at that stop and the bus is at the correct location. This criterion shall be further amended: the location of one stop is defined as the distance from the origin of one bus line. If the stop is shared by multiple lines, x_{stop,j_l} takes different values. The value of $\xi_j(k)$ is assumed to be the sum of all buses (regardless of which line the bus is on) that fulfill the location criterion. This means passenger boarding rate is multiplied when multiple buses are present. In mathematical form:

$$\begin{aligned} \xi_j(k) &= \sum_{l=1}^{M_L} \sum_{i_l=1}^{M_B} \exists i : (|x_{i_l}(k) - x_{stop,j_l}|) < \epsilon_1 \\ &\& p_{j_l}(k) \geq \epsilon_2 \& v_{i_l}(k) \leq \epsilon_3. \end{aligned} \quad (6)$$

This will start “dissipating” the number of passengers at stop j as it is assumed that $\alpha_j(k) < \lambda_j(k)$. In addition, boarding can only start if the bus has stopped at the bus stop (i.e. $v_{i_l}(k) \leq \epsilon_3$).

In the same vein, constraints shall be introduced for buses waiting at the stops too. When a bus is at a stop performing passenger exchange, its velocity shall be set to $v_{des,i} = 0$. If a bus is at a stop and there are passengers at a stop, it shall be stopped for passenger exchange. To this end, define a boolean variable for every bus as:

$$\eta_i(k) : \exists j_l : (|x_{i_l}(k) - x_{stop,j_l}|) < \epsilon_4 \ \& \ p_{j_l}(k) \geq \epsilon_5. \quad (7)$$

The two above criteria will activate in pairs. The bus will be held at the stop until all the passengers at that stop have boarded, i.e. $p_{j_l}(k)$ is reduced to zero. In the expression above (Eq. (7)) $p_{j_l}(k)$ relates to the stop where the bus i_l is. $\epsilon_{1..5}$ denote numerical tolerances. ϵ_1 and ϵ_4 shall be a few meters that the bus cannot go past the stop in one step, therefore it shall be greater than $v_{max}\Delta t$. The rest of the tolerances are small positive numbers.

2.3 Network model

Next, combine the bus models with the bus stop dynamics, devising a public transport network model.

$$X(k+1) = AX(k) + B_u u(k) + B_h h(k) + B_w w(k) \quad (8)$$

$$Z(k) = CX(k) + Dr(k) \quad (9)$$

The system is detailed in Eq. (14) and Eq. (15). The vector $h(k)$ represents the integer states of the system. If any of the buses i is at stop j , the corresponding state is one, enabling λ_j , modeling passenger boarding.

2.4 Reference trajectory generation

The two reference trajectories, outlined in Section 2.1 drive the buses on the network. These references shall be carefully planned offline. The timetable reference $x_{tt,i}(k)$ in Eq. (3) is based on a static timetable of each bus. In the bus network model, every bus line has an origin, and the locations of bus stops are measured as the distance from this origin. In this trajectory, average dwell times and travel times are assumed. When multiple lines share a stop, it has multiple locations. If a line is circular, the reference has to be reset if the bus finishes a trip. If the bus is late, the trajectory is only reset if it reached the end of the line, until that the reference position is kept at the length of the route (e.g. Figure 4, between 1150 – 1200 s). Otherwise, the reference would be much smaller than the actual position of the bus, eventually stopping it.

Headway reference $x_{hw,i}(k)$ (Eq. (4)) is the key in equalizing headways in merging and splitting road sections. When a bus travels on its own line, the target bus is the one traveling on the same line ahead it. The reference trajectory is created by shifting the trajectory of the target bus by one headway time, where headway is the ideal temporal distance between consecutive buses on that line. When buses use a shared line, the target is defined by a “pattern”, in what order buses follow each other Varga et al. (2018b). If a bus enters a common line, it selects a new target to follow and gets the trajectory of that target, shifted by the common time headway on that line. In addition, since lines can have different lengths, reference trajectories are

offset by the difference between the position the two lines entering the common section (see Figure 5). This reference trajectory is kept at the route length if the bus is late, in the same fashion as the timetable reference.

3. MODEL PREDICTIVE CONTROL

The proposed bus network model in Eq. (14) and Eq. (15) can be extended for a suitably long N prediction horizon. In order to formulate a model predictive controller, a cost function is needed. Let

$$J(k) = \frac{1}{2} (\mathcal{X}(k) \mathcal{Q}_x \mathcal{X}(k) + \mathcal{Z}(k) \mathcal{Q}_z \mathcal{Z}(k) + \mathcal{U}(k) \mathcal{R} \mathcal{U}(k)) \quad (10)$$

be the quadratic cost function with \mathcal{Q}_x , \mathcal{Q}_z , \mathcal{R} being diagonal, positive semi-definite matrices as weighting parameters. Each row in the weighting matrices correspond to one (predicted) state or control input. In $J(k)$ $\mathcal{X}(k)$ represents the evolution of the system states over the prediction horizon. The system state $X(k)$ is measured at time step k . Then, for a finite horizon length N the future states $X(k+c|k)$ are calculated along with the corresponding control inputs $u(k+c-1|k)$ and uncontrolled external input signals. Therefore, $\mathcal{X}(k) = [X(k+1|k), X(k+2|k), \dots, X(k+c|k), \dots, X(k+N|k)]^T$, $c = 1, 2, \dots, N$. In the same vein, the predicted control input sequence is $\mathcal{U}(k) = [u(k|k), u(k+1|k), \dots, u(k+c|k), \dots, u(k+N-1|k)]^T$. Similarly, the system performance outputs $\mathcal{Z}(k) = [z(k|k), z(k+1|k), \dots, z(k+c|k), \dots, z(k+N-1|k)]^T$, the logical states $\mathcal{L}(k) = [l(k|k), l(k+1|k), \dots, l(k+c|k), \dots, l(k+N-1|k)]^T$ and the uncontrolled external input signals $\mathcal{W}(k) = [w(k|k), w(k+1|k), \dots, w(k+c|k), \dots, w(k+N-1|k)]^T$ are extended. The system matrices are recursively extended too.

$$\begin{aligned} A &= \begin{bmatrix} A \\ A^2 \\ \vdots \\ A^N \end{bmatrix}, \quad B_u = \begin{bmatrix} B_u & 0 & \cdots & 0 \\ AB_u & B_u & & 0 \\ \vdots & \vdots & \ddots & \vdots \\ A^{N-1}B_u & A^{N-2}B_u & \cdots & B_u \end{bmatrix}, \\ B_w &= \begin{bmatrix} B_w & 0 & \cdots & 0 \\ AB_w & B_w & & 0 \\ \vdots & \vdots & \ddots & \vdots \\ A^{N-1}B_w & A^{N-2}B_w & \cdots & B_w \end{bmatrix}, \\ B_h &= \begin{bmatrix} B_h & 0 & \cdots & 0 \\ AB_h & B_h & & 0 \\ \vdots & \vdots & \ddots & \vdots \\ A^{N-1}B_h & A^{N-2}B_h & \cdots & B_h \end{bmatrix}, \\ C &= \begin{bmatrix} C & 0 & \cdots & 0 \\ 0 & C & & 0 \\ \vdots & \vdots & \ddots & \vdots \\ 0 & 0 & \cdots & C \end{bmatrix}, \quad D = \begin{bmatrix} D & 0 & \cdots & 0 \\ 0 & D & & 0 \\ \vdots & \vdots & \ddots & \vdots \\ 0 & 0 & \cdots & D \end{bmatrix}. \quad (11) \end{aligned}$$

By inserting the equations of the extended network model into the cost function (Eq. (10)) through $\mathcal{X}(k)$ and $\mathcal{Z}(k)$, and performing some mathematical reformulations the cost function can be organized into a quadratic function of the control input $\mathcal{U}(k)$. In Eq. (12a) the matrices Φ and Ω^T contain the stacked state-space matrices the initial system states, reference and disturbance inputs. The MPC control is defined by solving at each time step the following mixed integer quadratic program:

$$\min_{\mathcal{U}(k)} J(k) = \frac{1}{2} \mathcal{U}^T(k) \Phi \mathcal{U}(k) + \Omega^T \mathcal{U}(k), \quad (12a)$$

subject to:

$$\xi_j(k) \in \mathbb{Z}^* \quad \forall j, \quad (12b)$$

$$p_j(k) > 0 \quad \forall j, \quad (12c)$$

$$v_{min} \leq v_{des,i}(k) \leq v_{max} \quad \forall i, \quad (12d)$$

$$v_{des,i}(k) = 0 \text{ if } \eta_i = 1, \quad \forall i, \quad (12e)$$

$$\lambda_i = \min\{\lambda_{i,max}, p_i(k)\}. \quad (12f)$$

In other words, a desired velocity profile shall be predicted for every bus in the network considering the reference trajectories $x_{tt,i}(k..k+N)$, $x_{hw,i+1}(k..k+N)$ obeying the following constraints. $\xi_j(k)$ denotes passenger exchange at stop j . Its value equals the number of buses at the stop. A bus is performing passenger exchange if it is at the stop, its velocity is zero and there are passengers at the stop ($\eta_i(k) = 1$). The number of passengers at a stop cannot be smaller than zero. To this end, the passenger boarding rate is constrained. The desired velocity of the buses is bounded too. The system is loosely coupled through the integer states: since the control input is computed in a centralized way, the passenger numbers are calculated in relation of the buses of the network. If one bus takes passengers from a stop, the trajectory of the following bus is planned accordingly (e.g. less dwell time required).

The proposed optimization problem is a standard mixed integer quadratic problem (MIQP) which can efficiently be solved by existing solvers (e.g. Gurobi (2014)). The complexity of the problem, however, grows exponentially with additional system states or by increasing the prediction horizon, see Figure 1. The number of integer states in the search space (for $N = 1$ prediction horizon) can be computed as the sum of the following geometric sequence:

$$K = \sum_{c=0}^{M_B} \binom{M_B}{c} M_S^c. \quad (13)$$

In other words, there can be $0..M_B$ stops occupied by any combination of M_S buses. For example, in a 6 bus, 6 bus stop system, assuming every bus $M_B = 6$ can be at every stop $M_S = 6$, Eq. (13) gives $K = 117649$ combinations. Exploiting the network layout (not every bus serves every stop), the number of combinations can be reduced significantly.

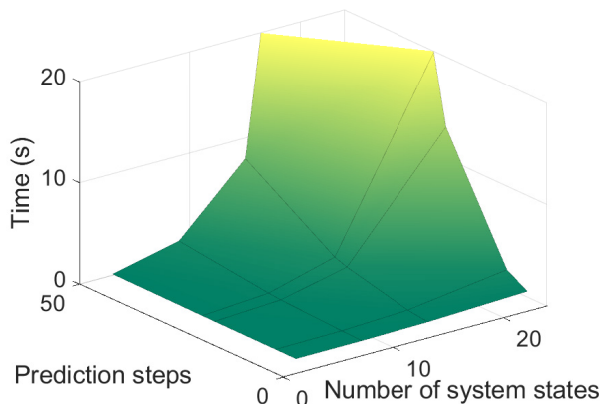

Fig. 1. Computational time of the centralized bus control problem at different network sizes and prediction horizons.

Note that, the proposed MPC does not have a terminal set, therefore, close-loop behavior shall be checked separately. The next section deals with this analysis.

4. ANALYSIS

In this section the centralized control algorithm is analyzed by three different techniques. First, simple case studies are constructed to test the controller in practical situations. Second, a several numerical simulations are performed from random initial conditions and the boundedness of the passenger number is analyzed in a probabilistic framework. Finally, set theoretical method is applied to characterize the feasibility region of the MPC algorithm.

4.1 Experimental results

In this section two simulation examples are given. First, the simulation results are analyzed from the relationship of one bus and a bus stop, i.e. how the system states behave when a bus enters a stop. Then, an experimental network consisting of two circular bus lines, six buses and six stops is analyzed. In the first simulation, in Figure 2, a bus travels towards a stop, located at 500 m and stops. When its speed is reduced to zero, passenger boarding can start (ξ is set to 1). When there are no passengers at the stop, the bus can continue its route. The prediction horizon is fixed: $N = 15$.

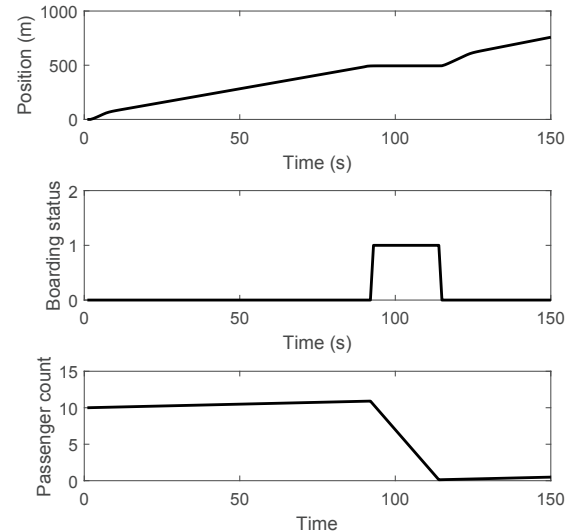

Fig. 2. System states upon a bus approaching a bus stop

Next, the system performance is analyzed through an arbitrary public transport network (Figure 3) consisting of two circular bus lines (2000 m and 2500 m) long, respectively. Three buses serve each line with four stops each. Two stops are shared. The time headway on both lines is 200 s, therefore, the headway on the common corridor is $\frac{200 \text{ s} \cdot 200 \text{ s}}{200 \text{ s} + 200 \text{ s}} = 100 \text{ s}$. The prediction horizon is $N = 15$.

Figure 4 depicts a single bus performing three laps on Line 1. In the first lap the tracking errors are bigger due to initialization. As time progresses, tracking performance

becomes better. At 1200 m the headway reference changes, since the bus enters the common route section and starts following a bus from Line 2. Next, every bus in the network is analyzed in time-space diagram (Figure 5). The trajectories of bus Line 1 are shifted by 500 m, so stops III and IV are situated in the same places. After initialization, buses start to equalize their headways, they arrive to the common section precisely, only minor speed adjustment is required after merging. Finally, Figure 6 shows the evolution of passenger numbers over time at one bus stop. The time when passenger numbers are decreasing are the exact same times, when there is a bus from Line 1 at Stop II in Figure 5.

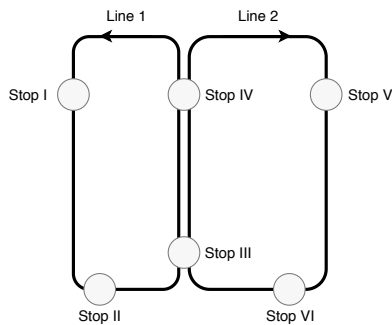

Fig. 3. Experimental network

Table 1. Bus stops on the experimental network

	Location Line 1 (m)	Location Line 2 (m)	Arrival rate (pass/s)
Stop I	500		0.05
Stop II	1000		0.05
Stop III	1200	800	0.1
Stop IV	1800	1400	0.1
Stop V		1700	0.02
Stop VI		2300	0.02

4.2 Random simulations

In this analysis step, several numerical simulations are launched from random initial conditions with the same model settings. The goal is to get quantitative information on the maximal passenger number, which is a practically relevant performance metric of the controlled bus network. Probabilistic measure is computed to quantify the validity of the result. More refined simulation based analysis can be performed by using the recent results of the scenario approach (Campi et al., 2009).

Here, the same example network is used as in Section 4.1. In such a high dimensional system varying every initial condition is especially exhausting. As a simplification, one scenario is defined with identical bus initial conditions (positions, velocities) and constant disturbances. The passenger number initial conditions are generated randomly (between 5 – 20 passengers) at each stop. The length of one simulation run is 500 s. The method involved $S = 500$ simulations with randomized (uniformly distributed) initial passenger numbers. Figure 7 depicts the sum of passenger numbers waiting at bus stops in the whole network. The red dotted line shows the last order statistics of the

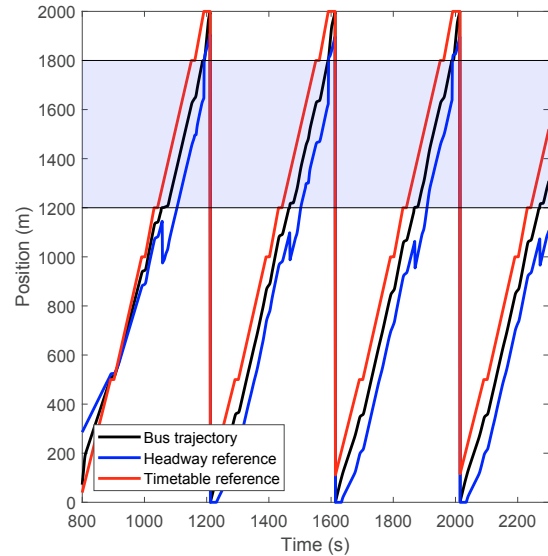

Fig. 4. Trajectory of one bus in the experimental network with its reference trajectories. The bus makes three laps. The shaded area denotes the common line section.

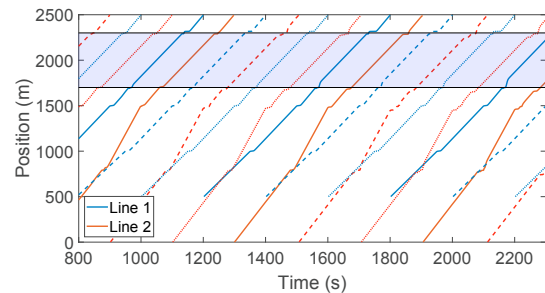

Fig. 5. Trajectory of every bus in the network. Different line styles are used to distinguish individual buses. Trajectories of Line 1 are shifted so positions match in the common line section.

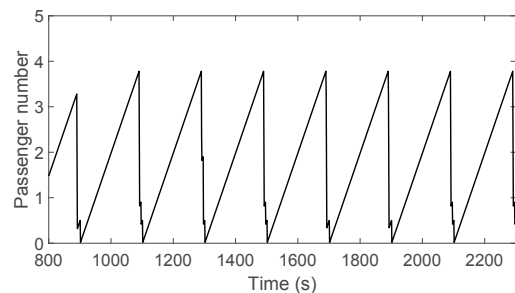

Fig. 6. Passenger numbers at Stop II

scenarios (David and Nagaraja, 2004). The probability of more passengers waiting than the simulated maximum is $\frac{1}{S+1} = 0.2\%$.

Simulation results suggest that after the buses reach their subsequent stop the passengers generated as the initial condition are taken and the periodicity is recovered. Remark: as there are no constraints on the passenger

numbers, feasible (but high cost) solution will always be found regardless of the initial conditions.

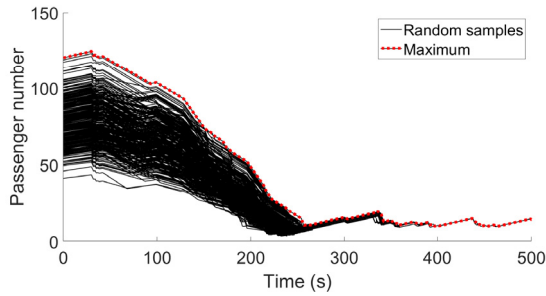

Fig. 7. Sum of accumulated passengers at every stop for every scenario

4.3 Set theory

In this section we aim to characterize the feasibility region of the MPC algorithm and analyze how its shape and size are changing when explicit constraints are prescribed for the maximal allowed passenger number. The approach we use is based on computing the explicit solution of the MPC problem in Eq. (12). The existence of an explicit MPC controller can guarantee feasibility of the system. Since the computation of the EMPC (especially for hybrid systems) is NP hard (Borrelli, 2003) and therefore the available methods (Herceg et al., 2013) works only for systems of moderate size. Therefore, we perform this analysis step on a simplified (3 buses, 2 stops) network model.

As the first step, the mixed integer problem is rewritten into a Piecewise-affine (PWA) system by separating Eq. (14) into different subsystems, depending on which binary state $\xi_i(k)$ is 1. Not only the state equations shall be separated but constraints too: when a bus is performing passenger exchange, it shall be stationary at the stop, therefore when a given affine system is active, the respective constraint shall be chosen too.

Then, the EMPC is designed for the bus network, considering the same constraints as in Section 3. When formulating the EMPC controller the reference signals for the buses are set to the end of the network. This way, when testing the system in closed-loop the control input is other than zero. The goal of the set based analysis is to check which regions of the state space yield feasible solution. If the EMPC cannot cover a partition of the state space, that means the solution is infeasible. To this end, a hypercube \mathcal{X} is defined bounding the valid system states (i.e. velocities from 0 to 13.5 m/s, bus positions from 0 to 2500 m and passenger number from 0 to 50 passengers per stop). Then, the intersection of the hypercube and the EMPC controller is calculated. If the intersection is equal to the initial polytope, the original MPC controller can cover the whole relevant state space. The steps of this analysis is summarized below.

Algorithm 1: Feasibility analysis with EMPC

Define: \mathcal{X} as a polytope of relevant states.

Compute an EMPC for Eq. (14).

Define: \mathcal{E} as the feasibility domain of the EMPC .

$\mathcal{I} = \mathcal{X} \cap \mathcal{E}$.

if $\mathcal{E} \setminus \mathcal{I} = \emptyset$ **then**

there are no infeasible states.

else

There are infeasible states.

Results show that there are no infeasible solutions. As a next step, two extra constraints are introduced to the system that may cause infeasibility: the maximum allowed number of passengers is constrained. If the number of allowed passengers at the stop is small, there may be bus states where buses cannot reach the stop before the stop overflows with passengers. Figure 8 depicts the projection of the EMPC controller's polyhedron to the state plane of the first bus ($[v_1, x_1]$). According to the figure, there exist feasible solution from every system state combination. On the other hand, when constraining the maximum allowed passengers strictly to 2 passengers per stop (Figure 9), the resulting EMPC controller yields feasible solution on a smaller set.

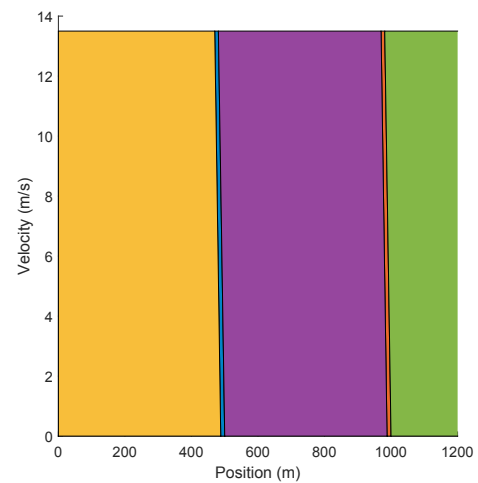

Fig. 8. EMPC projection to the state plane of the 1st bus with 12 passengers limit at stops

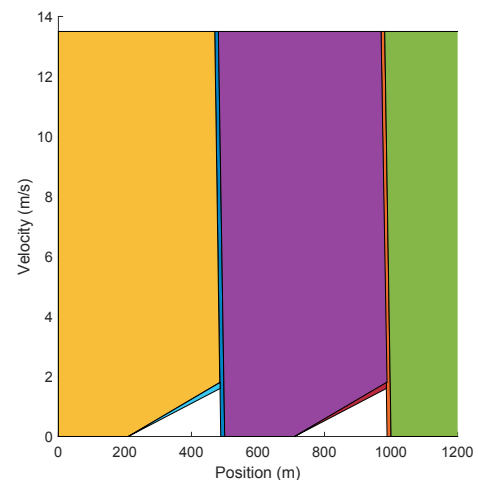

Fig. 9. EMPC projection to the state plane of the 1st bus with 2 passengers limit at stops

5. CONCLUSIONS AND FUTURE WORK

The paper presented a centralized control solution for urban public transport networks. The dynamics of individual buses and the accumulation of passengers at bus stops are combined into a single network model. The model captures the motion of vehicles in the vicinity of stops via integer states. The aim of the predictive model velocity control is selecting an optimal speed for buses in order to minimize three conflicting objectives: equidistant headways, timetable adherence and passenger wait. The system is capable of merging and splitting bus lines through the adjustment of the headway reference. Although the MPC can easily be developed for the network model, its analysis (because of its high dimension) proved challenging. The feasibility and performance of the system were analyzed employing three different methods.

5.1 Feasibility

With the help of the set theory based analysis feasible control regions were sought. This proved to be a numerically challenging task in such a high dimension system, so the analysis was only carried out for a smaller partition of the network. Since there are no conflicting constraints in the optimization, feasible solution could be found for the entire state-space. When additional constraints are introduced to ensure some system performance (e.g. low passenger waiting times) infeasible control regions appear.

5.2 Performance

Numerical simulations in a simple experimental network showed the temporal evolution of headways, and passenger numbers could maintain their periodicity with the help of velocity control. Randomized simulations aimed at finding a combination of an initial passenger count, where it takes the longest for the system to regain its steady state. Results of the randomized simulations indicate that the system is insensitive to the variation of passenger numbers. In addition, with a given probability, an upper bound for the passenger number can be given.

5.3 Future work

Although the centralized control shows good performance characteristics, it scales poorly with both system size and prediction horizon size. As a following step, the network-model should be decentralized and further analyzed.

6. ACKNOWLEDGEMENTS

This paper was partially supported by the János Bolyai Research Scholarship of the Hungarian Academy of Sciences and the ÚNKP-19-4 New National Excellence Program of the Ministry for Innovation and Technology. The authors acknowledge the contribution of Transport Area of Advance at Chalmers University of Technology. The project has been partially supported by Energimyn-digheten through the project ‘Operational Network Energy Management for Electrified buses’ (46365-1). The authors also thank B. Csáji for the useful discussions and references.

REFERENCES

- Ampountolas, K. and Kring, M. (2015). Mitigating bunching with bus-following models and bus-to-bus cooperation. In *IEEE 18th International Conference on Intelligent Transportation Systems (ITSC)*, 60–65. 15 - 18 September, 2015, Las Palmas, Spain.
- Borrelli, F. (2003). *Constrained Optimal Control of Linear and Hybrid Systems*. Springer Berlin Heidelberg.
- Campi, M.C., Garatti, S., and Prandini, M. (2009). The scenario approach for systems and control design. *Annual Reviews in Control*, 33(2), 149–157.
- Daganzo, C.F. and Pilachowski, J. (2011). Reducing bunching with bus-to-bus cooperation. *Transportation Research Part B: Methodological*, 45(1), 267–277.
- David, H.A. and Nagaraja, H.N. (2004). *Order Statistics*. Wiley.
- Gurobi (2014). Gurobi optimizer reference manual.
- Helbing, D. and Tilch, B. (1998). Generalized force model of traffic dynamics. *Physical review E*, 58(1), 133.
- Herceg, M., Kvasnica, M., Jones, C.N., and Morari, M. (2013). Multi-parametric toolbox 3.0. In *2013 European Control Conference (ECC)*. IEEE.
- Laskaris, G., Cats, O., Jenelius, E., Rinaldi, M., and Viti, F. (2018). Multiline holding based control for lines merging to a shared transit corridor. *Transportmetrica B: Transport Dynamics*, 7(1), 1062–1095.
- Newell, G.F. and Potts, R.B. (1964). Maintaining a bus schedule. In *Australian Road Research Board (ARRB) 2nd Conference*, volume 2. 1964, Melbourne, Australia.
- Schmöcker, J.D., Sun, W., Fonzone, A., and Liu, R. (2016). Bus bunching along a corridor served by two lines. *Transportation Research Part B: Methodological*, 93, 300–317.
- Sorratini, J., Liu, R., and Sinha, S. (2008). Assessing bus transport reliability using micro-simulation. *Transportation Planning and Technology*, 31(3), 303–324.
- Stephen Boyd, L.V. (2019). *Convex Optimization*. Cambridge University Press.
- Transportation Research Board (2016). *Highway Capacity Manual: A Guide for Multimodal Mobility Analysis*. The National Academies Press, Washington, D.C, 6 edition.
- Varga, B., Tettamanti, T., and Kulcsár, B. (2018a). Optimally combined headway and timetable reliable public transport system. *Transportation Research Part C: Emerging Technologies*, 92, 1–26.
- Varga, B., Tettamanti, T., and Kulcsár, B. (2018b). Optimal headway merging for balanced public transport service in urban networks. *IFAC-PapersOnLine*, 51(9), 416–421.
- Wu, W., Liu, R., and Jin, W. (2017). Modelling bus bunching and holding control with vehicle overtaking and distributed passenger boarding behaviour. *Transportation Research Part B: Methodological*, 104, 175–197.
- Xuan, Y., Argote, J., and Daganzo, C.F. (2011). Dynamic bus holding strategies for schedule reliability: Optimal linear control and performance analysis. *Transportation Research Part B: Methodological*, 45(10), 1831–1845.

