



Multibody simulation benchmark for dynamic vehicle-track interaction in switches and crossings: modelling description and simulation tasks

Downloaded from: <https://research.chalmers.se>, 2026-04-06 00:04 UTC

Citation for the original published paper (version of record):

Bezin, Y., Pålsson, B. (2023). Multibody simulation benchmark for dynamic vehicle-track interaction in switches and crossings: modelling description and simulation tasks. *Vehicle System Dynamics*, 61(3): 644-659.
<http://dx.doi.org/10.1080/00423114.2021.1942079>

N.B. When citing this work, cite the original published paper.



Multibody simulation benchmark for dynamic vehicle-track interaction in switches and crossings: modelling description and simulation tasks

Yann Bezin & Björn A. Pålsson

To cite this article: Yann Bezin & Björn A. Pålsson (2021): Multibody simulation benchmark for dynamic vehicle-track interaction in switches and crossings: modelling description and simulation tasks, Vehicle System Dynamics, DOI: [10.1080/00423114.2021.1942079](https://doi.org/10.1080/00423114.2021.1942079)

To link to this article: <https://doi.org/10.1080/00423114.2021.1942079>



© 2021 The Author(s). Published by Informa UK Limited, trading as Taylor & Francis Group



Published online: 05 Jul 2021.



Submit your article to this journal [↗](#)



Article views: 369



View related articles [↗](#)



View Crossmark data [↗](#)

Multibody simulation benchmark for dynamic vehicle-track interaction in switches and crossings: modelling description and simulation tasks

Yann Bezin ^a and Björn A. Pålsson ^b

^aInstitute of Railway Research, School of Computing and Engineering, University of Huddersfield, Huddersfield, UK; ^bCHARMEC/Dept. of Mechanics and Maritime Sciences, Chalmers University of Technology, Göteborg, Sweden

ABSTRACT

This paper presents the final description for the S&C Benchmark that was launched at the IAVSD 2019 conference held in Gothenburg, Sweden and completed by eighteen participants by the end of 2020. The purpose of this paper is to allow for the replication of the Benchmark exercise after publication for those who wish to do so in the future, and it includes a link to the repository containing all necessary input data. The original task description, including a description of the Benchmark submission, is presented in full. The results from the Benchmark are available in [Bezin Y, Pålsson BA, Kik W, et al. Multibody simulation Benchmark for dynamic vehicle-track interaction in switches and crossings: results and method statements. Submitted to VSD, 2021].

ARTICLE HISTORY

Received 5 March 2021
Revised 7 June 2021
Accepted 7 June 2021

KEYWORDS

Multibody systems;
rail-wheel interaction;
railway systems; track
models; track-vehicle
interaction

Introduction

A number of simulation benchmarks have been performed in railway mechanics throughout the years, for example [1–4]. A benchmark on Switches and Crossings (S&C, turnouts) has however been missing, and it has led the authors to develop the present benchmark initiative. S&C merit the attention of a tailored benchmark as they constitute some specific challenges in terms of modelling and simulation of dynamic vehicle-track interaction:

- (1) In S&C, there are large and sudden changes in rail profile geometry along the track. This constitutes a challenge in terms of rail surface geometry modelling. Given the stiffness of the wheel–rail contact, the slightest distortion in the rail surface description can induce a significant shift in contact conditions and result in large dynamic contributions to the wheel–rail contact forces.
- (2) Wheels passing through a switch or a crossing panel can make simultaneous contact with multiple rail bodies that can deform relative to one another, i.e. the stock rail and switch rail in the switch panel and the check rail and stock rail in the crossing panel. This calls for more elaborate track and wheel–rail contact modelling compared to plain line.

CONTACT Yann Bezin  y.bezin@hud.ac.uk

- (3) Due to the varying track and rail sections throughout S&C, track properties will vary along the track by design.

For this benchmark, participants are given the task to model the switch panel and crossing panel for two different S&C designs and to simulate dynamic vehicle-track interaction in those panels. Rail geometry data are provided in the form of discrete cross-sections and the track properties are represented using co-running track models with specified properties. Traffic is represented by the passenger vehicle from the Manchester Benchmarks [1], data reproduced in Appendix.

In doing so, this benchmark first addresses point (1) above. This is because the greatest source of result variation between participants and modelling approaches is expected to stem from the rail geometry and how it is represented between the given cross-sections.¹ Point (2) is accounted for in the benchmark as the track model features individual bodies for each independent rail. The challenge here is mostly to demonstrate the modelling and simulation capability for a track model with this topology, in particular allowing for simultaneous multiple points of contact of the wheel onto the track components. Less variability in results is expected to stem from this feature. Point (3) is accounted for via separate track properties for the switch and crossing panel, but the continuous variation during simulation is not addressed in this benchmark.

Modelling and simulation aspects aside, the driving force for benchmarking and pushing S&C simulation capabilities is to allow for improved input to the design and maintenance of S&C from the simulation community. The assumption is that such efforts in the end will reduce the significant expense that S&C operation constitutes for infrastructure owners.

This study covers the following topics defining the benchmark:

- (1) S&C nomenclature and geometry
- (2) Description of the two S&C designs included in the benchmark
- (3) Definition of the simulation cases to be evaluated and their modelling
- (4) Definition of the requested outputs
- (5) Definition of the requested method statement

The input geometry data required to complete the Benchmark are found in [5].

S&C nomenclature and geometry

A standard right-hand side S&C with nomenclature for the different components is presented in Figure 1. The pictured S&C features a straight section called the through route and a curved deviating part called the diverging route. The front of the S&C is defined as the start of the deviating curve in the switch panel. The switching function is realised by switch machines or actuators that position the movable switch rails according to the desired traffic route. The closure panel connects the switch and crossing panels, whereas the crossing panel allows for wheels to travel along either intersecting paths. Opposite to the crossing, and next to the adjacent stock rails, are the check rails that enforce a constraint on the lateral position of passing wheelsets, to avoid interference contact between wheels and the crossing nose in the unguided part of the crossing.

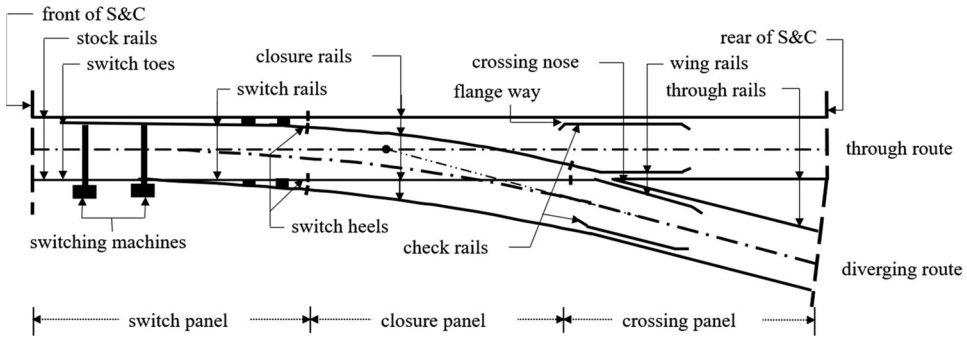

Figure 1. Layout, components and nomenclature for a standard right-hand side S&C. Figure from [6] with slight modification.

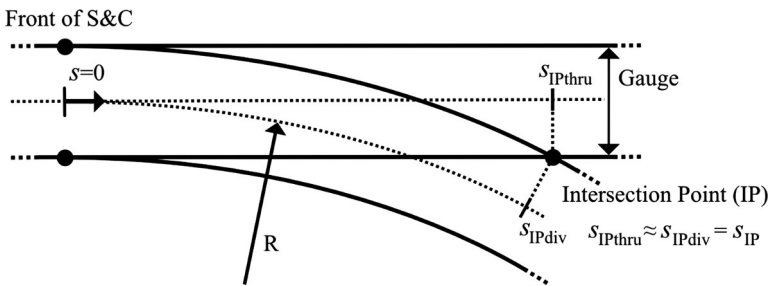

Figure 2. Geometric definition of S&C.

The geometric definition of S&C geometry is shown in Figure 2. The curvilinear track position coordinate s starts from the front of the S&C. The radius R of the diverging route, together with the gauge of the track, will determine where the intersection point (IP) is located, at distance s_{IP} from the front of the S&C. This is the point where the gauge lines of the straight through route and the diverging route cross. Due to the track curvature, s_{IP} will differ slightly between the through and the diverging route, but for all practical simulation purposes they can be assumed to be equal and that is the approach taken in this benchmark.

Description of S&C designs

Two different S&C configurations are considered in this Benchmark: a Swedish 60E1-R760-1:15 and a British 56E1-R245-1:9.25. The designs are chosen because they are common S&C types in their respective networks and they cover two different types of curving and load transfer conditions. They should, therefore, constitute representative and realistic simulation challenges for the researchers and engineers involved with the simulation of dynamic vehicle-track interaction in switches and crossings.

The 56E1-R245-1:9.25

The 56E1 vertical rail switch is a short switch used on lines with 56 kg rail sections, covering the majority of the British network and still common on intercity lines (up to 200 km/h).

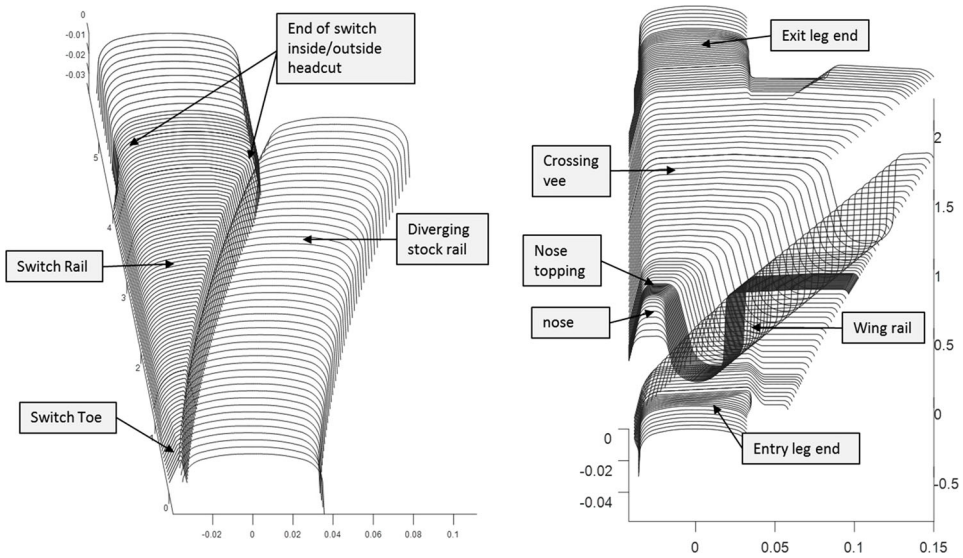

Figure 3. Components for the 56E1 vertical switch (left) and crossing (right) showing the rail cross-sections defined for simulation. Dimensions in metres.

Rails are installed vertically to ease the fixing/baseplate designs onto concrete or oak sleepers. Twist rails are placed outside the S&C layout to transition from 1:20 rail inclination to vertical, but not considered here. The layout is intersecting (i.e. switch radius intersecting with the mainline direction) and has a length s_{IP} of 25.025 m and a switch radius of 245.767 m matching that of the S&C curve for the natural crossing angle of 1:9.25. This gives a maximum S&C speed of 43 km/h. The gauge applied in this benchmark is the nominal 1435 mm, and although these turnouts are set at 1432 mm by design, they are often nearer to 1435 mm in practice.

The switch and stock rails are machined out of nominal 56E1 rail sections and reproduced in a CAD environment, applying the same machining tools and path as used in practice. This process is documented in [7]. The Crossing 3D geometry has been reproduced from the 56E1 crossing design made available by Network Rail and includes a machined radius of the gauge corner and a 1:20 sloped wing rail. Individual cross-sections are then extracted from the 3D geometry in longitudinal steps of 50 mm for the switch and in steps ranging between 5 mm and 40 mm for the case of the crossing, as shown in Figure 3.

The 60E1-R760-1:15

This S&C geometry corresponds to a Swedish 60E1-R760-1:15 S&C design. From the designation, we can read that it is based on (vertical) 60E1 rails, has a constant 760 m radius and a crossing angle of 1:15. The gauge is 1435 mm and the intersection point (IP) is located 46.7 m from the front of the S&C. The rail geometry for the switch and crossing panels is presented in Figure 4. The maximum speed in the diverging route is 80 km/h.

The rail geometry for the switch panel is a realisation of the Swedish railway administration's (Trafikverket) design described in their drawing 9-511401. The individual rail

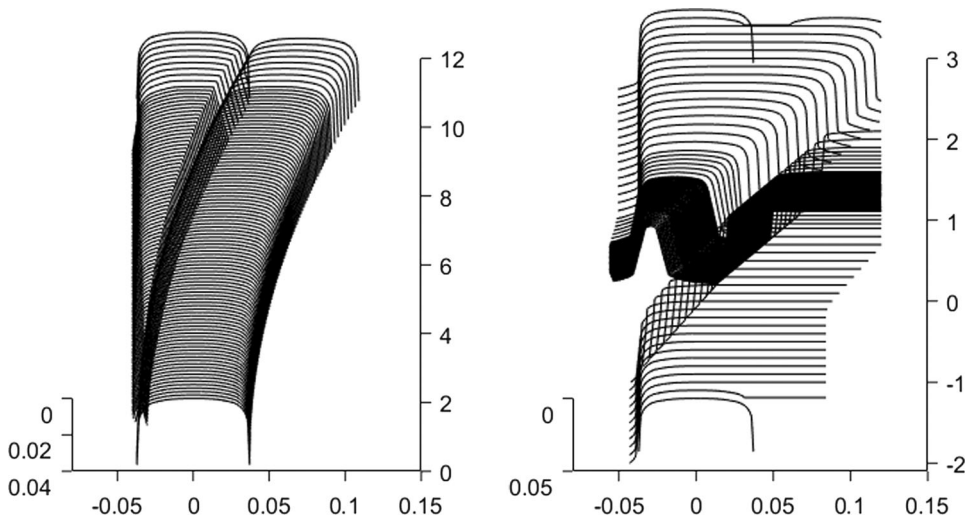

Figure 4. Components for the 60E1 vertical switch (left) and crossing (right) showing the rail cross-sections defined for simulation. Dimensions in metres.

cross-sections were generated using an in-house Matlab code that mimics the manufacturing (milling) process for switch rails [8]. A verification that the script generates cross-sections that are in agreement with the drawing design is presented in [9]. The rail cross-sections have a longitudinal spacing of 100 mm along the tapered section of the switch rail.

The crossing geometry for this S&C is based on drawings 9-519 425 and 1-514 177 from Trafikverket. It features the global geometry from these drawings (gauge corner outline, crossing nose top inclination), while the rail cross-section profiles have been optimised for minimised contact pressure. The geometry and its generation are presented in detail in [10]. The longitudinal profile spacing in the transition area of the crossing is 10 mm and coarser in the less transient regions.

This version of the 60E1-R760-1:15 with vertical rails is an older design. Today this S&C is built with 1:30 rail inclination which corresponds to the rail inclination of the Swedish network.

Simulation cases

For each S&C, the vehicle-track interaction is evaluated separately for the switch panel and the crossing panel. This allows for tailored track modelling for each panel and vehicle initial conditions before panel entry that are unaffected by the negotiation of any previous panel. The Benchmark simulation cases are listed in Table 1. The facing traffic direction is when the vehicle enters the S&C from the front end. In addition to the 8 S&C runs there is a 9th run corresponding to traffic in a standard curve with 245 m radius. The purpose of this run is to allow for the comparison of vehicle responses between participants without the influence from S&C rail geometry.

Table 1. The simulation cases to be evaluated in the benchmark.

| Run | S&C | Panel | Route | Direction | Speed [km/h] |
|-----|--------------------------------------------------------------------------------------------------------------------------------------------------------------------------------|----------|-----------|-----------|--------------|
| 1 | 56E1-R245-1:9.25 | Switch | Through | Facing | 100 |
| 2 | 56E1-R245-1:9.25 | Switch | Diverging | Facing | 43 |
| 3 | 60E1-R760-1:15 | Switch | Through | Facing | 160 |
| 4 | 60E1-R760-1:15 | Switch | Diverging | Facing | 80 |
| 5 | 56E1-R245-1:9.25 | Crossing | Through | Facing | 100 |
| 6 | 56E1-R245-1:9.25 | Crossing | Diverging | Facing | 43 |
| 7 | 60E1-R760-1:15 | Crossing | Through | Facing | 160 |
| 8 | 60E1-R760-1:15 | Crossing | Diverging | Facing | 80 |
| 9 | Identical to run #2 but with a constant 56E1 rail profile replacing the stock rail geometry and the switch rail geometry being removed (retaining the same track formulation). | | | | |

The global track geometry for each simulation case is presented in Figure 5. The corresponding rail geometry sets and their locations are presented in Figure 7.

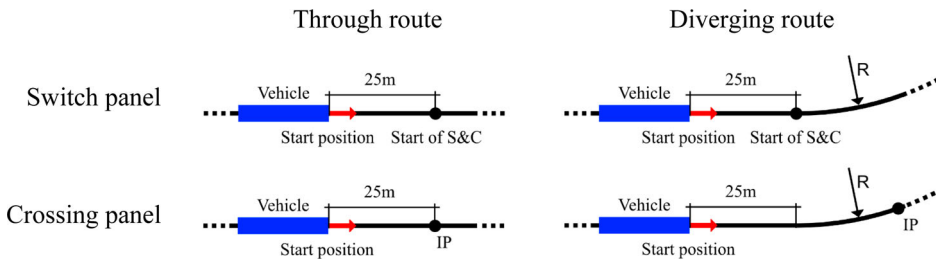
**Figure 5.** The track configuration and initial vehicle positioning for the different simulation cases.

Global track geometry

The track configurations and the corresponding initial vehicle placement of the four simulation cases for each S&C design are presented in Figure 5. The through route simulation cases are set up on an infinite tangent track. For the diverging route cases, the vehicle starts on a tangent track before it enters a curve of constant radius. For the purpose of the Benchmark, it can be assumed that the curve continues indefinitely with a constant radius. Track cant is always zero and no track irregularities are applied.

For all simulations, the vehicle should have at least 25 m of running on a perfectly tangent track to find a quasi-static condition before it reaches the front of the S&C or the intersection point (IP). The vehicle should be perfectly centred on the track in this quasi-static condition to avoid that any initial disturbance influences results downstream. For the crossing panel simulations in the diverging route, the vehicle should travel the full distance in the curve before it reaches the IP. This means that the IP should be located 25 m into the curve for the R245 S&C and 46.7 m into the curve for the R760 S&C. The component of interest (stock/switch rail or crossing rail) is always placed on the right-hand side, this means that the diverging cases are left-hand curves and the through cases correspond to right-hand side turnouts.

The fact that the studied S&Cs have constant radii and no transition zones is an important track modelling aspect as this means a discontinuous change in track curvature from infinite to a constant non-zero value. This is not feasible for a numerical integrator and a transition with varying track curvature is, therefore, required. It is recommended to make this transition as short as the simulation tool allows, preferably in the order of decimetres.

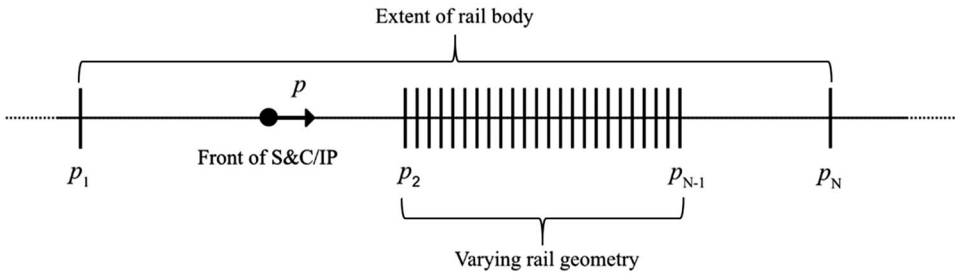

Figure 6. Generic illustration of rail body definition. The vertical lines indicate individual 2D cross-section profiles and p_i their positions along the track relative to the front of the S&C or the IP. p_1 , p_2 , p_{N-1} and p_N normally consist of nominal rail shapes, while p_3 to p_{N-2} consist of varying rail shapes.

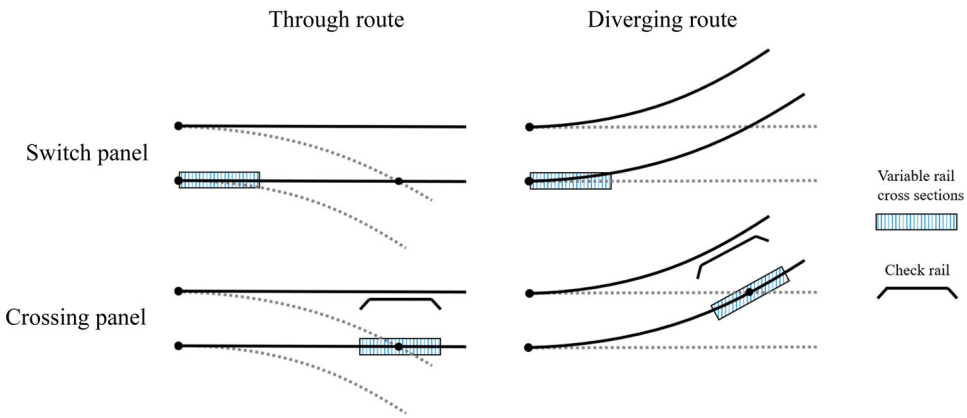

Figure 7. Locations for varying rail geometry for the simulation cases in Table 1.

Rail profile geometry

The profile geometry for each rail body is defined via a number of 2D rail cross-sections that are given relative to the front of the S&C ($s = 0$) for the switch panel and relative to the IP for the crossing panel ($s = s_{IP}$), as shown in Figure 2. A generic rail body definition is visualised in Figure 6. The extent of the rail body along the track is defined by the start and end cross-section (p_1 to p_N). The profile geometry sets in the area of varying shape are illustrated in Figures 3 and 4.

The location of the varying rail geometry for the different simulation cases of Table 1 is illustrated in Figure 7. For each simulation case, only the corresponding rail bodies should be used. For example, only the crossing and check rail bodies should be included for the crossing panel simulations, while only the varying main stock rail and switch rail bodies are to be included in the switch panel simulations.

In the implementation of the varying profile geometry, it is open to the participant to modify the extent or discretisation of each cross-section provided it does not significantly affect the geometry in areas of wheel–rail contact. Such modifications could, for example, be helpful or necessary in improving geometry interpolation.

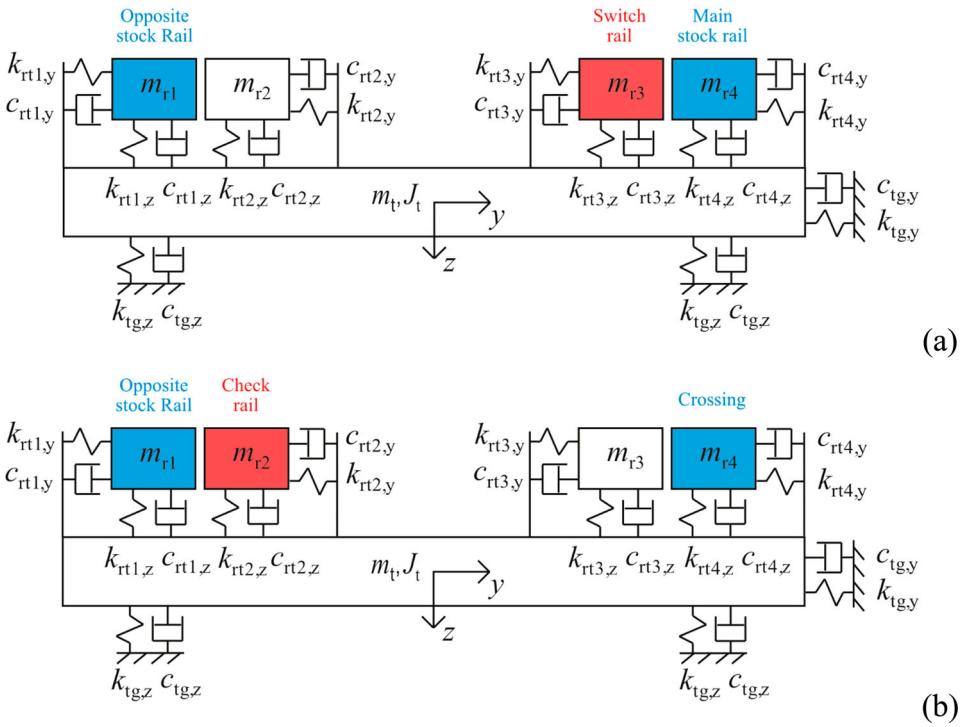

Figure 8. Topology of the co-running track model for the switch (a) and crossing (b) cases.

Track model

The track model consists of a planar co-running system of masses and bushing elements, replicated independently for each wheelset. The model topology is presented in Figure 8 and the parameter values are presented in Table 2. The track model has 11 degrees of freedom in total. The track mass has three degrees of freedom (vertical, lateral and rotation in-plane) and all rail masses have two degrees of freedom (vertical and lateral) with respect to the track mass.

For traffic in the switch panel rail masses 1, 3 and 4 correspond to opposite stock rail, switch rail and the main stock rail, respectively. In the crossing panel rail masses 1, 2 and 4 correspond to opposite stock rail, check rail and crossing rail, respectively. The rail mass that is not active in a given simulation should be disabled or given a negligible mass (say one kg). In the given track body coordinate system, the lateral semi-spacing for all rail masses is $y = \pm 0.75$ m. This means that the two masses on each side of the track overlap in the model implementation. All bushing elements between rail masses, ground and track mass also have a lateral semi-spacing of 0.75 m and can be assumed to connect to the track mass at $z = 0$. If vertical pre-loads are applied in the bushing elements to aid simulation initialisation, they should be applied equally to all rail bushings to not introduce a relative shift in the rails' vertical positions. Lateral pre-loads should not be used.

Table 2. Track model parameters.

| Parameter | Switch panel | Crossing panel |
|----------------------------|-----------------|-----------------|
| <i>Vertical properties</i> | | |
| $k_{rt1,z}$ | 150 | 150 |
| $c_{rt1,z}$ | 100 | 100 |
| $k_{rt2,z}$ | Body not active | 150 |
| $c_{rt2,z}$ | Body not active | 100 |
| $k_{rt3,z}$ | 150 | Body not active |
| $c_{rt3,z}$ | 100 | Body not active |
| $k_{rt4,z}$ | 150 | 500 |
| $c_{rt4,z}$ | 100 | 350 |
| $k_{tg,z}$ | 140 | 200 |
| $c_{tg,z}$ | 1400 | 2000 |
| <i>Lateral properties</i> | | |
| $k_{rt1,y}$ | 30 | 30 |
| $c_{rt1,y}$ | 150 | 150 |
| $k_{rt2,y}$ | Body not active | 30 |
| $c_{rt2,y}$ | Body not active | 150 |
| $k_{rt3,y}$ | 30 | Body not active |
| $c_{rt3,y}$ | 150 | Body not active |
| $k_{rt4,y}$ | 30 | 30 |
| $c_{rt4,y}$ | 150 | 150 |
| $k_{tg,y}$ | 70 | 100 |
| $c_{tg,y}$ | 350 | 500 |
| <i>Masses</i> | | |
| m_t | 1400 | 2000 |
| m_{r1} | 60 | 60 |
| m_{r2} | Body not active | 60 |
| m_{r3} | 60 | Body not active |
| m_{r4} | 60 | 180 |
| J_t | 450 | 700 |

Stiffnesses (k) are given in kN/mm, damping coefficients (c) in Ns/mm, masses (m) in kg and moments of inertia (J) in kgm^2 .

Wheel–rail contacts

The following wheel–rail contact pairs should be defined between each wheelset and the rail bodies.

For the switch panel

- (1) Contact between the opposite stock rail (rail mass 1) and the left wheel
- (2) Contact between the switch rail (rail mass 3) and the right wheel
- (3) Contact between the main stock rail (rail mass 4) and the right wheel

For the crossing panel

- (1) Contact between the opposite stock rail (rail mass 1) and the left wheels
- (2) Contact between the check rail (rail mass 2) and the left wheels
- (3) Contact between the crossing rail (rail mass 4) and the right wheels

The wheel–rail contact friction coefficient is 0.35. The choice of normal and tangential contact modelling is up to the individual benchmark participant.

Table 3. First nine output channels.

| Channel | Output quantity | Unit |
|---------|-----------------------------------------------------------------------------------------------------------------------------------------------------------------------------------------------------------------------------------------------------------------------------------------------------------------------------------------|---------------------|
| 1 | Time from the start of simulation | [s] |
| 2 | Leading wheelset of leading bogie longitudinal track position (with respect to the start of S&C/IP) | [m] |
| 3 | Leading wheelset of leading bogie lateral displacement | [mm] |
| 4 | Trailing wheelset of leading bogie lateral displacement | [mm] |
| 5 | Leading wheelset of leading bogie angle of attack | [mrad] |
| 6 | Trailing wheelset of leading bogie angle of attack | [mrad] |
| 7 | Vertical distance between wheel profile and rail profile reference coordinate systems (i.e. relative kinematic vertical movement between wheel and rail) for the right-hand side leading wheel. (The wheel traveling over the switch and crossing components). For the switch panel, the main stock rail should be chosen as reference. | [mm] |
| 8 | Absolute vertical motion of right-hand side leading wheel. | [mm] |
| 9 | Lateral acceleration of the car body at CoM height above the front bogie centre pivot. This point is located at 1800mm above the top of rail and 9500 mm forward of the car body's centre of mass [1]. | [m/s ²] |

Vehicle model

For all simulation cases, the traffic is represented by the passenger vehicle from the Manchester Benchmarks [1], data reproduced in Appendix. The wheel profile is a nominal S1002 [11] that is provided with the input dataset. The flange back of this profile has been slightly extended to provide a full contact surface between the flange back and check rail. The vehicle speed (according to Table 1) should be maintained constant throughout each simulation by, for example, prescribing the speed of the car body.

Simulation outputs

The requested outputs from each simulation are presented in Tables 3 and 4. Table 3 lists the first nine channels which correspond to single output quantities. Table 4 lists a block of wheel–rail interaction outputs that should be reported for each wheel–rail contact pair of the leading axle in the first bogie. The channel numbering is as follows [switch panel/crossing panel]

- (1) Channels 10–42 [Opposite stock rail/Opposite stock rail]
- (2) Channels 43–75 [Switch rail/Check Rail]
- (3) Channels 76–108 [Main stock rail/Crossing rail]

The outputs should cover at least $[-5$ to $+15]$ m of track distance from the start of the S&C (switch case) and $[-5$ to $+5]$ m from the IP (crossing case) for each requested axle output. The data output sampling frequency should be 2 kHz for the simulations in the switch panel and 10 kHz for simulations in the crossing panel. Run number 9 of Table 1 should have the same output settings as the switch panel simulations. The absence of results for a given channel is represented with zeros. Accuracy should be down to three decimal places minimum as per the requested unit. The output data should be unfiltered.

Coordinate representations

Unless otherwise stated, the outputs should be given in a right-handed coordinate system at the longitudinal track position of the axle that the results originate from. The x -direction

Table 4. Output block of 33 Channels for wheel–rail interaction quantities.

| Channel | Output quantity | Unit |
|----------|-----------------------------------------------------------------------------------------|--------------------|
| 10 | Q – Total vertical wheel–rail contact force for the given wheel–rail contact pair | [kN] |
| 11 | Y – Total lateral wheel–rail contact force for the given wheel–rail contact pair | [kN] |
| 12 | X – Total longitudinal wheel–rail contact force for the given wheel–rail contact pair | [kN] |
| 13,14,15 | Lateral position on rail for wheel–rail contacts cp1, cp2, cp3 | [mm] |
| 16,17,18 | Contact patch size for cp1, cp2, cp3 | [mm ²] |
| 19,20,21 | Contact patch angle for cp1, cp2, cp3 | [mrad] |
| 22,23,24 | Longitudinal tangential creepages for cp1, cp2, cp3 | [–] |
| 25,26,27 | Lateral tangential creepages for contacts in channels cp1, cp2, cp3 | [–] |
| 28,29,30 | Spin creepages for contacts in channels cp1, cp2, cp3 | [1/m] |
| 31,32,33 | Longitudinal tangential creep force for contacts in channels cp1, cp2, cp3 | [kN] |
| 34,35,36 | Lateral tangential creep force for contacts in channels cp1, cp2, cp3 | [kN] |
| 37,38,39 | Spin torque for contacts in channels cp1, cp2, cp3 | [kNm] |
| 40,41,42 | Normal contact force for contacts in channels cp1, cp2, cp3 | [kN] |

The numbering for the first block is given. The channel numbers for the two consecutive blocks is obtained by adding 33 or 66 to the given channel numbers.

should be tangent to the track centre line (and positive in the direction of motion), y positive to the right and z positive downwards. The origin is located on the track centre line laterally and at the nominal top of rail vertically.

The following additional remarks apply:

- (1) For wheel–rail contact forces, the force component acting on rail should be given.
- (2) The lateral contact point positions on rail should be given in the local profile coordinate system with respect to the nominal rail crown centreline (i.e. the zero lateral coordinate of the profiles provided with the Benchmark definition). The profile coordinate systems have the same orientation as the main coordinate system described above (i.e. positive y is towards the right for rails on both sides).
- (3) For creepages and creep forces, the results should be given in a local right-handed coordinate system for the corresponding contact patch. Here the z -axis is normal to the contact patch plane and the x -axis is parallel to the tangent of the track centre line. The direction of the y -axis follows from the vector cross-product of the z and x -axis base vectors.

Method statement

In addition to the simulation results, each participating partner was asked to submit a method statement at least answering the following questions:

- (1) The simulation tool used to perform the Benchmark simulations (including version number if applicable).
- (2) How the provided rail geometry was implemented, if any modifications were made (e.g. resampling, trimming, smoothing etc.) and if so mention the reasons.
- (3) The method used for interpolation between given file cross-section (online/tabulated) in the given software and how accuracy was ensured.
- (4) How the co-running track model was implemented and if any modifications were necessary.

- (5) How the discontinuous change in curve radius (from tangent track to diverging S&C curve) was modelled.
- (6) How the wheel–rail contact was modelled, in terms of wheel–rail coupling definition and the normal and tangential contact theory used for individual contact points. By wheel–rail coupling, it is here meant how the wheel–rail contact search is performed in time-domain simulations and what relative degrees of freedom (displacement, roll, yaw) between the rail and wheel that it accounts for.
- (7) Integration method used and how the convergence of results was ensured.
- (8) Any issues encountered during implementation and the necessity of developing independent tools are not readily available. Any practical knowledge gained in the process.
- (9) Any other information the participant finds important to convey related to the benchmark.

The method statement formed an integral part of the submission and the requested length was 2–4 pages.

Results

The results of the benchmark and discussion of the methods applied are published in [12].

Note

1. For example, whether interpolation between adjacent profiles is performed on the geometry itself and the contact problem is solved on-line, or if the contact problem is solved in advance for each cross-section and interpolation is performed in look-up tables during simulation.

Disclosure statement

No potential conflict of interest was reported by the author(s).

Funding

The formulation of this benchmark has been partly funded by The European Union's Horizon 2020 research and innovation programme in the project In2Track2 under grant agreement No. 826255; The UK Engineering and Physical Sciences Research Council under the programme [grant number EP/M025276/1], 'The science and analytical tools to design long life, low noise railway track systems (Track to the Future)'.

ORCID

Yann Bezin  <http://orcid.org/0000-0002-0599-8696>

Björn A. Pålsson  <http://orcid.org/0000-0002-2237-8560>

References

- [1] Iwnicki S. Manchester benchmarks for rail vehicle simulation. *Veh Syst Dyn.* 1998;30(3-4):295–313.
- [2] Grassie SL. Models of railway track and vehicle/track interaction at high frequencies: results of benchmark test. *Veh Syst Dyn.* 1996;25:243–262.

- [3] Spiriyagin M, Wu Q, Cole C. International benchmarking of longitudinal train dynamics simulators: benchmarking questions. *Veh Syst Dyn.* 2017;55(4):450–463.
- [4] Bruni S, et al. The results of the pantograph-catenary interaction benchmark. *Veh Syst Dyn.* 2015;53(3):412–435.
- [5] Bezin Y, Pålsson BA. Multibody simulation benchmark for dynamic vehicle-track interaction in switches and crossings: input dataset. University of Huddersfield; 2019. DOI:10.34696/s60x-ay18.
- [6] Kassa E, Andersson C, Nielsen JCO. Simulation of dynamic interaction between train and railway turnout. *Veh Syst Dyn.* 2006;44(3):247–258.
- [7] In2Track. Deliverable 2.2, enhanced S&C whole system analysis, design and virtual validation (final), Chapter 3. 2019.
- [8] Pålsson BA. Design optimisation of switch rails in railway turnouts. *Veh Syst Dyn.* 2013;51(10):1619–1639.
- [9] Capacity4Rail. Deliverable 1.3.3 innovative concepts and designs for resilient S&Cs (final). 2017.
- [10] Pålsson BA. Optimisation of railway crossing geometry considering a representative set of wheel profiles. *Veh Syst Dyn.* 2015;53(2):274–301.
- [11] CEN, EN13715:2020 Railway applications – wheelsets and bogies – wheels – tread profile. 2020. Brussels, Belgium.
- [12] Bezin Y, Pålsson BA, Kik W, et al. Multibody simulation Benchmark for dynamic vehicle-track interaction in switches and crossings: results and method statements. Submitted to VSD, 2021.

Appendix. Manchester Benchmark Vehicle 1 definition

Original publication: <https://www.tandfonline.com/doi/abs/10.1080/00423119808969454>

Vehicle based on the ERRI B176 benchmark vehicle, without yaw dampers, and with the following major simplifications:

- Simple primary suspension
- Symmetric vehicle
- Non-inclined dampers with simple damping rates

Masses and Inertias

| | |
|-------------------|----------------------------|
| <i>Wheelsets:</i> | |
| Mass | 1813 kg |
| Roll inertia | 1120 kgm ² |
| Pitch inertia | 112 kgm ² |
| Yaw inertia | 1120 kgm ² |
| <i>Bogies:</i> | |
| Mass | 2615 kg |
| Roll inertia | 1722 kgm ² |
| Pitch inertia | 1476 kgm ² |
| Yaw inertia | 3067 kgm ² |
| <i>Body:</i> | |
| Mass | 32,000 kg |
| Roll inertia | 56,800 kgm ² |
| Pitch inertia | 1,970,000 kgm ² |
| Yaw inertia | 1,970,000 kgm ² |

Suspension characteristics

| | |
|--------------------------------------------|-----------------------|
| <i>Primary suspension:</i> | <i>(x4 per bogie)</i> |
| Longitudinal stiffness | 31,391 kN/m |
| Nominal damping in parallel | 15 kNs/m |
| Damping series stiffness | 60,000 kN/m |
| Lateral stiffness | 3884 kN/m |
| Nominal damping in parallel | 2 kNs/m |
| Damping series stiffness | 7500 kN/m |
| Vertical stiffness | 1220 kN/m |
| <i>Secondary springs (see note 1):</i> | <i>(x2 per bogie)</i> |
| Longitudinal shear stiffness | 160 kN/m |
| Lateral shear stiffness | 160 kN/m |
| Vertical stiffness | 430 kN/m |
| Bending stiffness | 10.5 kNm/rad |
| <i>Secondary roll bar</i> | <i>(x1 per bogie)</i> |
| Stiffness | 940 kNm/rad |
| <i>Secondary longitudinal traction rod</i> | <i>(x1 per bogie)</i> |
| Stiffness | 5000 kN/m |
| Nominal damping in parallel | 25 kNs/m |
| Damping series stiffness | 10,000 kN/m |
| <i>Secondary lateral bumpstop</i> | <i>(x1 per bogie)</i> |

Symmetric characteristic

| | | | | | | | | | | |
|---|----|------|------|------|------|-------|-------|------|-------|-----|
| 0 | 25 | 30 | 35 | 40 | 45 | 50 | 55 | 60 | 65 | /mm |
| 0 | 0 | 0.60 | 1.76 | 3.73 | 6.87 | 11.58 | 17.17 | 29.2 | 230.0 | /kN |

Damper characteristics

| | |
|------------------------------------|-----------------------|
| <i>Primary vertical dampers:</i> | <i>(x4 per bogie)</i> |
| Damping rate | 4 kNs/m |
| Series stiffness | 1000 kN/m |
| <i>Secondary lateral dampers:</i> | <i>(x2 per bogie)</i> |
| Damping rate | 32 kNs/m |
| Series stiffness | 6000 kN/m |
| <i>Secondary vertical dampers:</i> | <i>(x2 per bogie)</i> |
| Damping rate | 20 kNs/m |
| Series stiffness | 6000 kN/m |

Vehicle dimensions

| | |
|-------------------------------------------------------------|---------|
| Bogie semi-pivot spacing | 9500 mm |
| Bogie semi-wheelbase | 1280 mm |
| Wheel radius | 460 mm |
| Height above the rail level of bogie centre of gravity | 600 mm |
| Height above the rail level of body centre of gravity | 1800 mm |
| Longitudinal and lateral offset of body cg from body centre | 0 mm |

Suspension geometry

| | |
|----------------------------------------------------------|---------|
| <i>Primary springs: (see Note 2)</i> | |
| <i>if using elements with a fixed line of action:</i> | |
| Longitudinal semi-spacing (x1) | 1280 mm |
| Lateral semi-spacing (y1) | 1000 mm |
| Height above the rail level (h1) | 460 mm |
| <i>if using elements with variable line of action:</i> | |
| Longitudinal element | |
| Wheelset end semi-spacing (x1) | 1280 mm |
| Bogie frame end semi-spacing (x2) | 830 mm |
| Lateral element | |
| Wheelset end semi-spacing (y1) | 1000 mm |
| Bogie frame end semi-spacing (y2) | 600 mm |
| Vertical element | |
| Height of wheelset end (h1) | 460 mm |
| Height of bogie frame end (h2) | 880 mm |
| <i>Secondary springs:</i> | |
| Longitudinal semi-spacing (x3) | 9500 mm |
| Lateral semi-spacing (y3) | 1000 mm |
| Height above the rail level of the top (h3) | 1130 mm |
| Height above the rail level of the bottom (h4) | 525 mm |
| <i>Secondary longitudinal traction rod (see note 2):</i> | |
| Height above the rail level (h5) | 600 mm |
| Longitudinal semi-spacing bogie end (x3) | 9500 mm |
| <i>if using elements with variable line of action:</i> | |
| Longitudinal semi-spacing body end (x4) | 8300 mm |
| <i>Secondary lateral bumpstop:</i> | |
| Height above the rail level (h6) | 650 mm |
| <i>Primary vertical dampers:</i> | |
| Longitudinal semi-spacing (x1) | 1280 mm |
| Lateral semi-spacing (y1) | 1000 mm |
| Height above the rail level of wheelset end (h1) | 460 mm |
| Height above the rail level of bogie frame end (h2) | 880 mm |
| <i>Secondary lateral dampers:</i> | |
| Lateral semi-spacing of bolster end (y4) | 665 mm |
| Lateral semi-spacing of bogie end (y5) | 230 mm |
| Height above the rail level (h7) | 700 mm |
| <i>Secondary vertical dampers:</i> | |
| Lateral semi-spacing (y6) | 1300 mm |
| Height above the rail level of the top (h8) | 925 mm |
| Height above the rail level of the bottom (h9) | 400 mm |

Note 1:

Where the software package offers an integrated shear spring element which includes the effects of vertical load on the lateral forces and end moments this type of element should be used. If a software package does not offer this type of element, the geometry and parameters of the spring elements, chosen to represent the shear spring, should be reported in the benchmark report.

Note 2:

If a software package allows suspension elements, whose line of action remains fixed irrespective of perpendicular movements of their ends, then this type of element should be used acting through the given point and may have zero or arbitrary length. For software packages, which only offer suspension elements, which change the line of action in response to movements of their ends, the given geometry should be used.

The vehicle is shown in figures V1a and V1b.

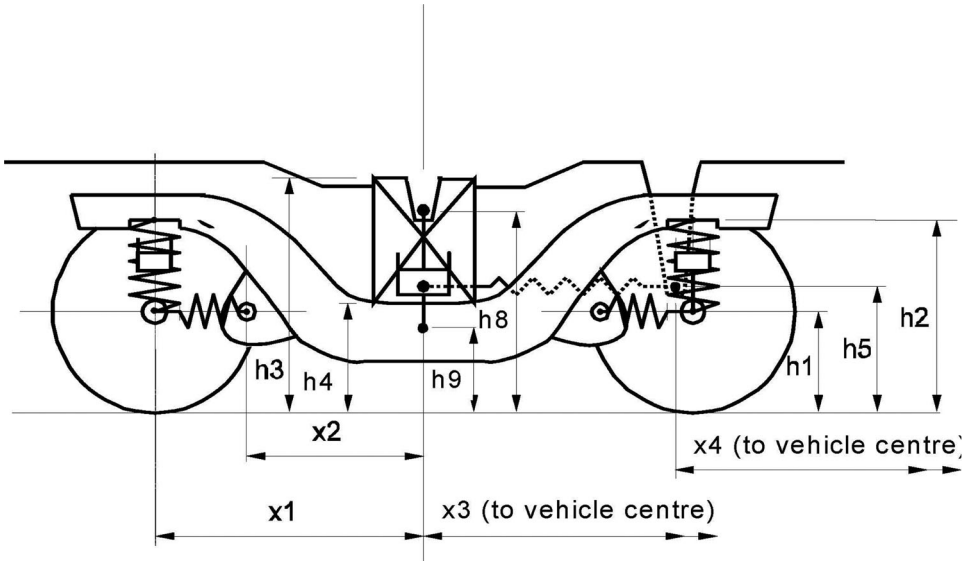

Figure A1. Benchmark vehicle 1 (side view).

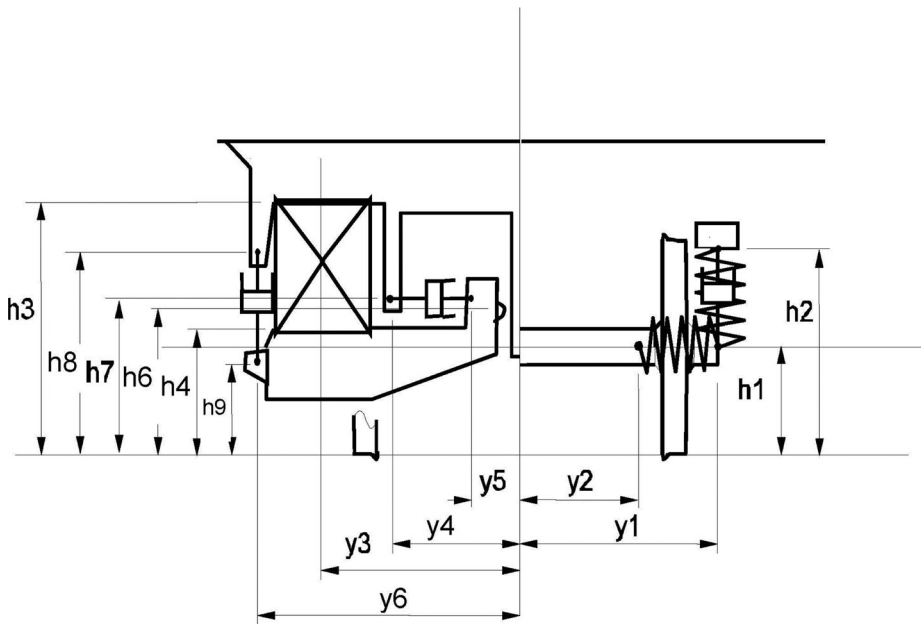

Figure A2. Benchmark vehicle 1 (end view and section of bogie).