



Energy Renovation Strategies for Office Buildings using Direct Ground Cooling Systems

Downloaded from: <https://research.chalmers.se>, 2026-04-05 14:43 UTC

Citation for the original published paper (version of record):

Arghand, T., Javed, S., Trüschel, A. et al (2021). Energy Renovation Strategies for Office Buildings using Direct Ground Cooling Systems. *Science and Technology for the Built Environment*, 27(7): 874-891. <http://dx.doi.org/10.1080/23744731.2021.1890520>

N.B. When citing this work, cite the original published paper.

Energy renovation strategies for office buildings using direct ground cooling systems

TAHA ARGHAND* , SAQIB JAVED , ANDERS TRÜSCHEL and JAN-OLOF DALENBÄCK 

Division of Building Services Engineering, Department of Architecture and Civil Engineering, Chalmers University of Technology, Gothenburg, 412 96, Sweden

Direct ground cooling systems (DGCS) can provide comfort cooling to buildings without the use of any refrigeration-based cooling methods. DGCS is an emerging technology, commonly used for new office buildings in cold climates. This study aims to evaluate the energy-saving possibilities of a DGCS compared to a conventional chiller system for an existing office building. A typical Swedish office building with a chiller-based cooling system and in need of an energy renovation is taken as a reference case. Various possible renovation measures are applied on the building and to the cooling system, and the results are evaluated in terms of borehole design and building energy demand. The results show that applying the DGCS substantially reduces the building's purchased energy, as chiller electricity demand is eliminated. In addition, implementing the renovation measures to reduce the thermal demand of the building could further reduce purchased energy. The results suggest implementing the DGCS after performing the renovation measures. This may lead to a considerable reduction in the required borehole length and hence in the drilling costs. Results from this study provide useful inputs for designing boreholes in ground-coupled systems for new and existing office buildings.

Introduction

Energy renovation is a holistic approach to reducing energy use and improving the occupants' thermal comfort by applying cost-effective measures. Energy renovation can take various forms aiming to reduce the building's heating, cooling, and electricity demands and to facilitate the use of renewable energy sources (De Boeck et al. 2015; Gram-Hanssen 2014; Jensen and Maslesa 2015).

Among different ground-coupled technologies available, the direct ground cooling system (DGCS) is an emerging technology for cooling commercial buildings in cold climates. In DGCSs, cooling is provided without the use of mechanical refrigeration, by circulating the heat carrier fluid through deep boreholes drilled in the ground (Arghand 2019). These systems are mainly feasible in cold climates

where a large difference between ground and indoor temperatures facilitates heat transfer between the ground and the building. The thermal performance of the DGCSs, determined as the ratio of total delivered cooling energy to the electrical energy usage, has been reported to be as high as 13 – 27 (Eicker and Vorschulze 2009; Filipsson et al. 2020; Man et al. 2015; Spitler and Gehlin 2019).

Using the DGCSs for new buildings is a viable alternative. Suitable measures can be considered in the design process to reduce the building's cooling demand and, consequently, the required borehole length and the borehole installation costs. However, adopting this cooling technology for existing buildings presents some challenges in terms of application. If the DGCS installation costs become unreasonably high, the exclusion of the chiller system may not warrant the potential benefits. To reduce the installation costs of the DGCS, particularly the cost of drilling boreholes, it is important to determine how the renovation parameters can influence the building cooling demand and the resulting ground loads.

The influence of certain building design parameters on the sizing and/or the thermal performance of the DGCSs has been reported from previous studies. Javed et al. (2018) optimized the borehole system design by adjusting the solar heat gains to balance the ground loads. Arghand et al. (2021c) investigated the sensitivity of borehole outlet fluid temperature levels for various room temperature set-points and internal heat gains. Romaní et al. (2016) and Arghand et al. (2021a) investigated the potential reduction in the required borehole length using

Received December 3, 2020; Accepted February 6, 2021

Taha Arghand, Msc, Student Member ASHRAE, is a PhD candidate. **Saqib Javed, PhD**, is an Associate Professor. **Anders Trüschel, PhD**, is a Senior Lecturer. **Jan-Olof Dalenbäck, PhD**, is a Professor.

*Corresponding author e-mail: arghand@chalmers.se

This is an Open Access article distributed under the terms of the Creative Commons Attribution-NonCommercial-NoDerivatives License (<http://creativecommons.org/licenses/by-nc-nd/4.0/>), which permits non-commercial re-use, distribution, and reproduction in any medium, provided the original work is properly cited, and is not altered, transformed, or built upon in any way.

variable room temperature set-point control methods. In a similar context, Romání et al. (2018) and Arghand et al. (2021b) investigated the possibility of reducing the required borehole length by applying pipe-embedded terminal units to reduce the daily peak intensity.

Based on the existing literature, two research gaps have been identified. First, in all of existing studies, borehole design was investigated as a function of only one design parameter, that is, room temperature set-point, window G-value, terminal unit type, and so on. Each of these parameters was effectively used to change the building load profile to optimize the borehole design. In practice, however, several measures must be incorporated in order to meet the target building energy demand, such as 60–70 kWh/m²-y (Boverket 2018; Shnapp et al. 2013), often used as a goal for comprehensive renovations in European and Swedish office buildings. While some measures aim at reducing the cooling load, others seek to lower the heating load. If not chosen appropriately, the aggregation of the measures can inversely affect the ground-coupled sizing and its thermal performance.

Second, the main benefit of incorporating the DGCSs in the building energy renovation plans is to cut down the electrical energy consumed by chillers. The existing literature does not quantify the energy-saving potential offered by the DGCSs. It only evaluates the electrical energy demand of DGCSs in existing buildings (Arghand et al. 2019; Filipsson et al. 2020; Kurnitski 2012). To the best of the authors' knowledge, no previous study has performed comparisons of the electricity demands between a chiller and a DGCS.

This work aims at evaluating the possibilities of applying a DGCS to an existing office building originally equipped with a chiller. The objective of the study is to compare the electrical energy demand of a building cooled by a chiller to a building cooled by a DGCS. Another objective is to evaluate the impact of possible energy renovation measures on the building thermal loads and the borehole system design. A typical Swedish office building using a chiller and an active chilled beam (ACB) system and in need of energy renovation is taken as the reference case. The design strategy used in this work is a step-by-step approach to implement energy renovation measures on the reference building. In the first step, the chiller is replaced by a DGCS, aiming to make a preliminary design of the borehole system. In the second step, the selected energy renovation measures are applied to the reference building in the framework of a parametric study. The results are analyzed in terms of the building heating and cooling loads and the required borehole length. In the final step, a renovation package consisting of several preinvestigated renovation measures is applied to the reference building to reduce the required borehole length. The final results concern the building's energy performance and borehole design before and after the renovation package is performed.

Methods

A medium-sized office building model based on a model developed by the U.S. Department of Energy (DOE) (Deru et al. 2011) is used to feature a simple yet realistic building. By using this building model, applying common renovation

practices in Sweden, and addressing the pros and cons of each renovation measure, we get comparable results using only one building model. The energy simulations are performed with IDA-ICE version 4.8 (EQUA Simulation Technology Group 2014, 2018). IDA-ICE has been developed primarily for building energy modeling and has been validated against measurements under the frameworks of various standards, including CIBSE TM33 (Moosberger 2007), ANSI/ASHRAE 140 (EQUA Simulation Technology Group 2010) and EN 13791 (Kropf and Zweifel 2001). Ground-coupled heating and cooling systems can also be modeled by using the borehole extension (Eriksson and Skogqvist 2017).

The reference building is assumed to be located in Gothenburg, in southwest Sweden. Gothenburg has long and cold winters and cool or warm summers, which represents the cold climate specifications based on the Kottek et al. (2006) classifications. IDA ICE uses a climate file provided by the ASHRAE Handbook of Fundamentals 2013 (ASHRAE 2013).

Reference building description

The reference building is designed to represent a medium-sized Swedish office building from the 1970–1980s. The building has three floors with a total floor area of 4981 m² (Figure 1). Each floor is divided into five zones: a large interior zone enclosed by four perimeter zones. Ribbon windows extend all over the building, with a window-to-wall ratio of 34%.

The perimeter zones' cooling loads are caused by the external heat gains, that is, solar radiation, and the internal heat gains, that is, people, equipment, and lights. The cooling load in the interior zone is mainly caused by the internal heat gains. The internal gains consist of heat generated by the office equipment (12.2 W/m²), people (8.0 W/m²), and lighting fixtures (10.6 W/m²), according to ASHRAE Handbook—Fundamentals (ASHRAE 2017). The internal gains are active during working hours, which are weekdays from 8:00 to 17:00.

Table 1 summarizes the main features of the geometry and the external structure of the reference building. Thermal properties of the building shell are based on survey results on nonresidential buildings in Sweden constructed in the 1970s–1980s (EU Building Stock Observatory 2016).

An electric chiller provides cold water at a supply temperature of 5 °C. The nominal coefficient of performance (COP) of the chiller is 2.7, according to Deru et al. (2011). The calculated annual COP, the ratio between the cooling energy provided and the electricity used, is 2.4. The chiller operates from 06:00 to 17:00 on workdays.

The cooling system in the building is equipped with ACBs. ACBs are convective-based terminal units utilizing water as the main heat carrier fluid. Air is mainly used to maintain the indoor air quality, but it may also contribute to space thermal conditioning if supplied at a lower temperature than the room temperature. The IDA Indoor Climate and Energy (IDA-ICE) models include ACBs as an

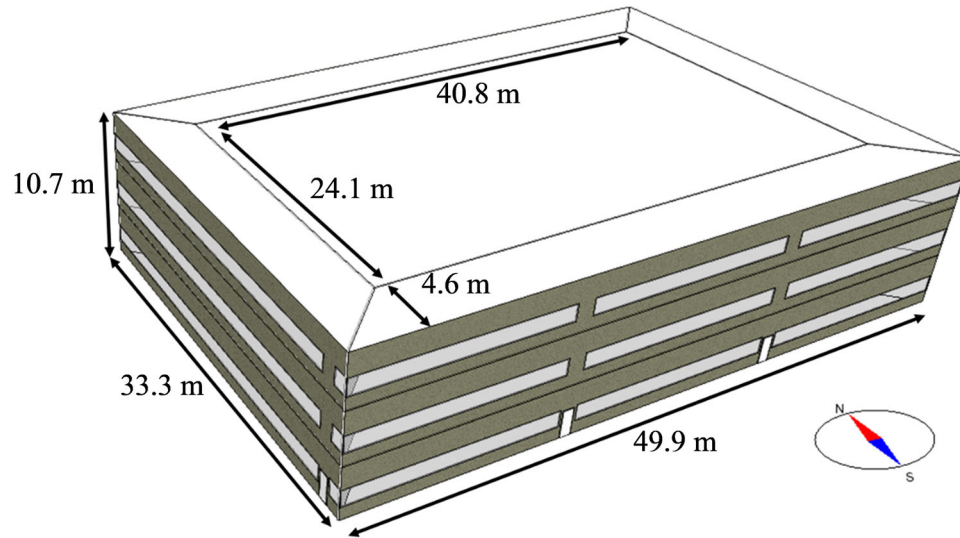

Fig. 1. Isometric view of the reference building, showing the perimeter and the interior zones.

Table 1. Main features of the geometry and external structure of the reference building.

| | |
|---|--------|
| Geometry | |
| Building occupancy type | Office |
| Number of floors | 3 |
| Total floor area (m ²) | 4981 |
| Window-to-wall ratio (%) | 52 |
| Thermal properties | |
| Average envelope U-value (W/m ² -K) | 0.57 |
| Windows G-value (-) | 0.76 |
| U-value of external walls (W/m ² -K) | 0.4 |
| U-value of roof (W/m ² -K) | 0.27 |
| U-value of windows (W/m ² -K) | 2.86 |
| U-value of base floor connected to the ground (W/m ² -K) | 0.3 |

integrated terminal unit with a water coil heat exchanger and an air diffuser. [Appendix A](#) gives a detailed description of the modeling of ACBs in IDA-ICE.

An air handling unit (AHU) provides ventilation air to the ACBs at a constant flow rate of 1.5 L/s-m² (1.5 air changes per hour [ACH]) and a temperature of 20 °C. The AHU provides 100% outdoor air to the building and is equipped with a heat recovery unit with a thermal efficiency of 0.7. This airflow rate is calculated for landscaped low-polluted office buildings in Category II in EN 16798 (CEN 2019). The airflow rate considers 1.2 L/s-m² for air quality requirements (0.7 L/s-m² and 0.5 L/s-m² for emissions from building and occupancy, respectively) and an additional 0.3 L/s-m² for thermal conditioning of the space. The cooling system operates from 06:00 to 17:00. The occupancy period is between 08:00 and 17:00. The prestart time is initiated to precool and preventilate the space before it is occupied. Preventilating the space is in compliance with recommended design ventilation criteria in office buildings, outlined by EN 16798 (CEN 2019). The cooling system

works only on weekdays. The cooling temperature set-point for the reference building is 24 °C. [Table 2](#) summarizes the main input design parameters of the ACBs.

Like most Swedish commercial buildings, the building is connected to a district heating system. The building is heated by a radiator system designed for a 55 °C supply temperature at outdoor temperature design conditions (-12 °C in Gothenburg) with a room temperature set-point of 21 °C. A heat recovery unit with a thermal efficiency of 0.7 is installed in the air handling unit to preheat outdoor air during the heating period. The heating system is off between June and August.

Proposed renovation measures

The reference building features an old Swedish office building from the 1970s–1980s, and is assumed to be in need of an energy renovation to reduce running costs. Building energy renovations are commonly implemented to reduce a building's heat losses and cooling demand, and to facilitate

Table 2. Specifications of the ACBs used in the reference building.

| | |
|--|------------------------|
| Operation time period (–) | 06:00–17:00 weekdays |
| Primary airflow rate (L/s-m ²) | 1.5 |
| Exhaust airflow rate (L/s-m ²) | 1.5 |
| Primary air temperature (°C) | 20.0 |
| $T_{\text{return,water}} - T_{\text{supply,water}}$ at maximum power (K) | 3 |
| Average supply water temperature (°C) | 17.0 |
| ACB cooling capacity control method | On/off water flow rate |
| Room temperature set-point for cooling (°C) | 24.0 |

the use of renewable energy sources (Gustafsson 2017; Haase et al. 2011; Jradi et al. 2017; Rose and Thomsen 2015). With a main goal of adopting the DGCS, the renovation measures are studied in relation to their influence on the building load profile and the required size of the borehole. Therefore, a relevant combination of the measures is applied to the building, and the outcomes in terms of the borehole system design and the building's energy demand are then discussed.

Single measures

The renovation measures considered are classified into two categories: building design and cooling system operational settings. The measures for building design include envelope U-value, windows G-value, and heat released from the office equipment and lighting. The cooling system's operational strategies include room temperature set-point and precooling strategies.

The average envelope U-value of the reference building is 0.57 W/m²-K and includes the U-values for the glazing, external walls, roof, and slab toward the ground, as summarized in Table 1. U-values for the reference building envelope feature a typical old commercial building in Sweden constructed in the 1970s and 1980s (EU Building Stock Observatory 2016). Other U-values are taken based on the suggestions of the Swedish national board of housing (Boverket) and a database of Swedish commercial buildings constructed after 2010 (Boverket 2018; EU Building Stock Observatory 2016).

There is no mandatory requirement regarding the G-value of windows. However, decreasing the G-value can considerably reduce the building's cooling loads, which in turn reduces the size of the building's cooling system. The retrofitting measures aim at reducing the G-value from 0.76 to 0.30, a range often found in the literature (Østergård et al. 2017; Yildiz et al. 2012).

Internal heat gains in the reference building are 30.8 W/m², including heat generated by people (8.0 W/m²), lighting (10.6 W/m²), and equipment (12.2 W/m²). The equipment heat gain assumes an office equipped with a workstation connected to two screens per person and one printer per eight people (ASHRAE 2017). After the renovation, the heat gains from people, lighting, and equipment are reduced to 8.0 W/m², 5.0 W/m², and 5.0 W/m², respectively, resulting in a total internal heat gain of 18.0 W/m².

The reference building has a temperature set-point of 24.0°C. In this study, we have used air temperature as the set-point temperature instead of operative temperature. This assumption is possible if the average room air temperature of the zones does not differ significantly from the operative temperature (CEN 2019).

The room temperature range in summer is 22.0–26.0°C, as recommended by Swedish recommendations and guidelines (BELOK 2015; Boverket 2018; Swedish Work Environment Authority 2009).

Night cooling is incorporated into the ventilation system to precool the building and is scheduled between June and August. The system operates from 00:00 to 06:00 on weekdays and from 18:00 to 00:00 on Sundays when the ambient temperature is below the room temperature set-point. The outdoor air at ambient temperature is supplied to the zones through the ACBs without any heating and cooling. The system keeps operating to cool the zones to 21.0°C, below which the controller stops the system to avoid thermal comfort issues for the occupants in morning hours. Two ventilation flow rates of 0.75 ACH and 1.5 ACH are examined for night cooling.

A summary of the proposed renovation measures is given in Table 3.

Combined measures

The reference building is primarily equipped with a chiller and is denoted as “Ref-chiller.” The main aim here is to design a DGCS for a renovated building. This is done using two scenarios. The first scenario considers replacing the chiller with a DGCS and is referred to as “Ref-DGCS.” The second scenario includes applying the selected renovation measures to the reference building equipped with the DGCS and is denoted “Renovated.” In the second scenario, the combined effect of the selected renovation measures is applied to the reference building to reduce the building's thermal and electricity demands. The renovation measures are chosen based on the results presented in the individual scale section. Table 4 compares the renovation measures used in the case studies.

Direct ground cooling system

A schematic of the cooling system under study is shown in Figure 2. Space cooling is provided by a DGCS. The DGCS consists of the borehole system and the building's cooling system.

Table 3. A comparison summary of the renovation measures used in the individual measure analysis.

| Renovation measures | Variable | Range of variability |
|------------------------------------|---|--------------------------------------|
| Building design | Window G-value (-) | From 0.76 to 0.3 with a step of 0.15 |
| | Envelope U-value (W/m ² -K) | From 0.57 to 0.17 with a step of 0.1 |
| | Internal heat gains (W/m ²) | From 30.8 to 18.0 with a step of 4.3 |
| Cooling system operational setting | Temperature set-point (°C) | From 26 to 22 with a step of 2 |
| | Night cooling airflow rate (ACH) | 0.75 and 1.5 |

Table 4. Design parameters used in the combined measures analysis.

| Variable | Ref-chiller | Ref-DGCS | Renovated |
|---|-------------|----------|-----------|
| Envelope U-value (W/m ² -K) | 0.57 | 0.57 | 0.42 |
| Window U-value (-) | 2.86 | 2.86 | 1.2 |
| Windows G-value (-) | 0.76 | 0.76 | 0.3 |
| Internal heat gains (W/m ²) | 30.8 | 30.8 | 18.0 |
| Cooling system | Chiller | DGCS | DGCS |
| Night cooling airflow rate (ACH) | 0 | 0 | 1.5 |

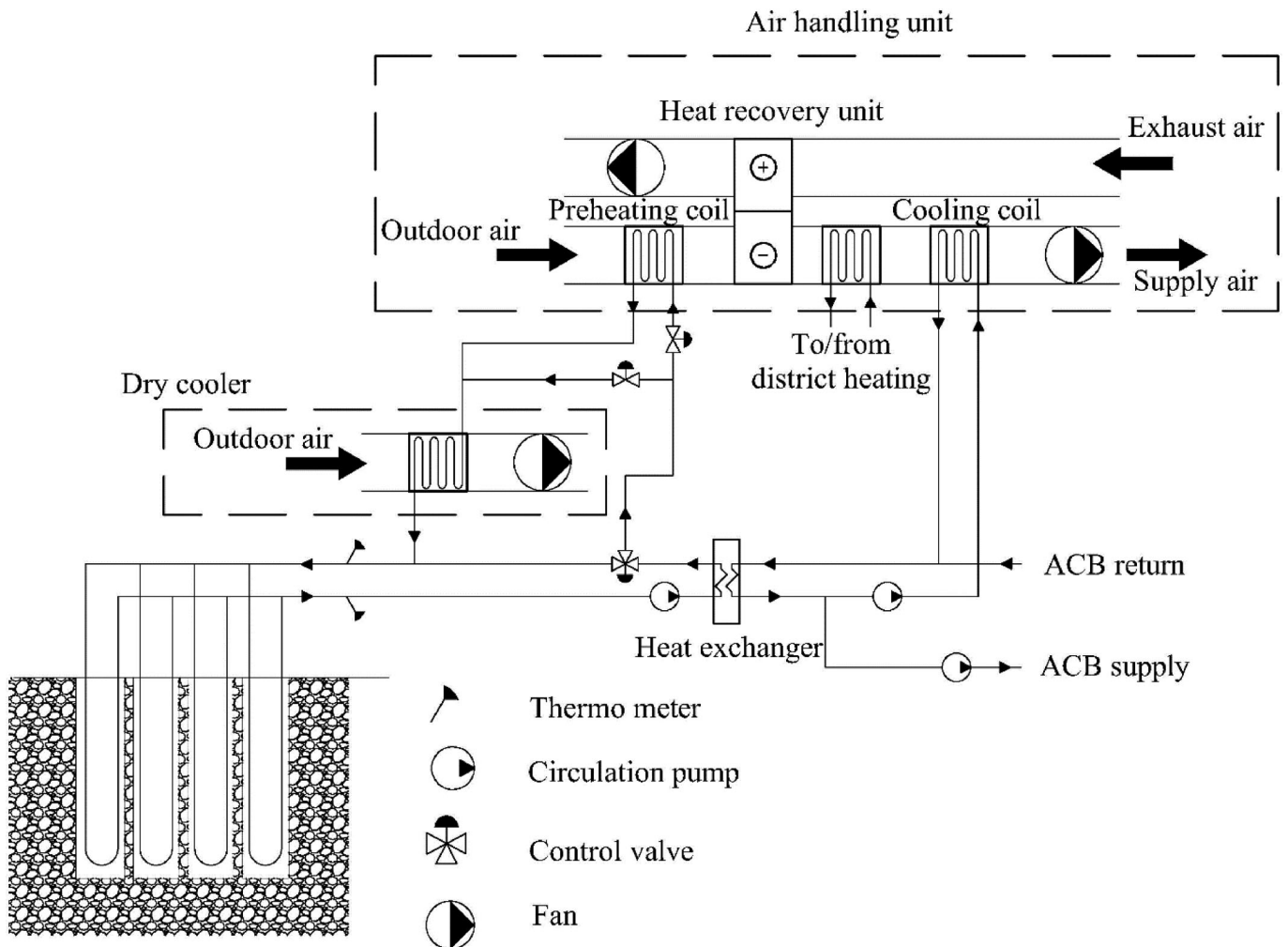

Fig. 2. Schematic of the DGCS.

Table 5. Borehole and ground specifications for the reference building.

| | |
|-------------------------------------|-------------------------|
| Borehole | |
| Diameter (mm) | 110 |
| Filling material | Groundwater |
| Thermal resistance (m-K/W) | 0.07 |
| Ground | |
| Undisturbed ground temperature (°C) | 8.3 |
| Ground thermal conductivity (W/m-K) | 3.0 |
| U-tube | |
| U-tube type (-) | Single U-tube |
| Pipe type (-) | Polypropylene, PN8 DN40 |
| Inner diameter (mm) | 35.4 |
| Outer diameter (mm) | 40.0 |
| Thermal conductivity (W/m-K) | 0.42 |
| Circulating fluid | |
| Type | Ethanol (29.5 %) |
| Thermal conductivity (W/m-K) | 0.401 |
| Specific heat capacity (J/kg-K) | 4120 |
| Freezing point (°C) | -18.5 |

The borehole system consists of single U-tube borehole heat exchangers (BHEs) drilled vertically into hard rock. The boreholes are filled with groundwater, as is the common practice in Sweden, since the groundwater level at the site is close to the ground surface (Spitler et al. 2016).

The DGCS is operated as a thermally balanced system. In a thermally balanced ground-coupled system, the annual heat rejection to and extraction from the ground is kept balanced to avoid increasing the annual ground temperature due to the long-term heat buildup in the ground. The borehole system requires excessively large ground heat exchangers if the system is not thermally balanced.

In this study, the heat rejected to the ground by the DGCS is extracted during the heating season to preheat the ventilation air. A control system is used to compare the annual ground heat rejection and extraction loads. The control system allows extracting heat from the ground until it becomes equal to the total heat rejection loads. For cases where the annual building cooling demand exceeds what can be compensated by this method, a dry cooler can be supplemented to the system. Therefore, the borehole heat carrier fluid can be further cooled for a longer period, even when the air handling unit is not in operation. If the annual balance cannot be achieved, the remaining load is added to the next year's load.

When the outdoor temperature is below 12 °C, the mixing valve diverts the whole heat carrier fluid to the preheating coil located in the air handling unit to preheat the primary air to the beams (see Figure 2). The cooled fluid is then circulated through the BHEs to cool the ground. When the outdoor temperature is above 12 °C, the control valve directs the working fluid to the BHEs. The working fluid is also sent directly to the BHEs if the borehole outlet fluid temperature is <2 °C. This stops the circulation to the preheating coil and avoids freezing the ethanol-to-water heat exchanger.

When the dry cooler and air handling unit are in use simultaneously, the fluid goes first to the preheating coil and

then to the dry cooler. During the nonworking hours of the air handling unit, the fluid only circulates through the dry cooler coil, as the valve to the preheating coil is shut.

The ground-coupled cooling system is modeled with the IDA-ICE borehole extension (EQUA Simulation Technology Group 2014). The model calculates the upward and downward fluid temperature along the U-pipe by performing transient heat conduction calculations within and around the boreholes. The calculations are performed using a combination of the finite-difference technique and the superposition method based on the following principles (Eriksson and Skogqvist 2017):

- One-dimensional (1D) heat transfer calculations for the inlet and outlet fluid in BHE along the U-tube's axial direction. The influence of the fluid flow rate in the BHE is considered by taking the Reynolds number into account. It should be noted that the thermal mass of pipe material is neglected.
- One-dimensional heat transfer calculations between the fluid, filling material, and ground along the U-tube's radial direction.
- Two-dimensional (2D) heat transfer calculations between the BHE wall and the surrounding ground in cylindrical coordinates.

The energy balance equations of the fluid and filling material are detailed in Appendix B.

Table 5 provides the borehole specifications and ground thermal properties used in the simulations. The borehole setup and the thermal properties of the ground are actual data obtained from a thermal response test conducted on an 80-m borehole drilled at the Chalmers University of Technology campus in Gothenburg, Sweden. The results were documented and reported by Javed (2010).

The thermal resistance provided in Table 4 is the effective thermal resistance measured through a thermal response test. Thermal resistance of the IDA-ICE borehole

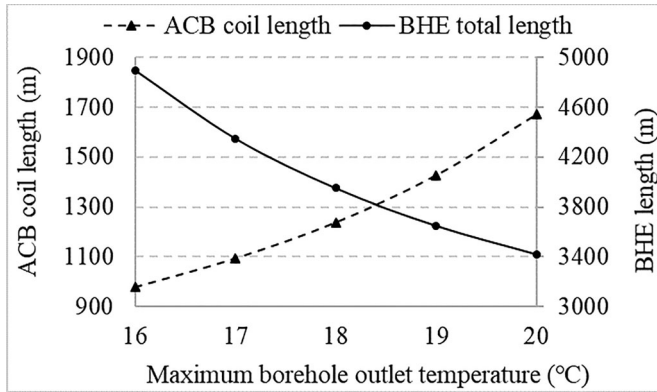

Fig. 3. Required BHE length and ACB coil length in relation to the maximum borehole outlet temperature for the reference building equipped with the DGCS.

model is calculated based on the method proposed by Spitler et al. (2016) for groundwater-filled boreholes. The 2D borehole thermal resistance under a turbulent flow condition (Reynolds number > 2300) is calculated to be 0.07 m-K/W .

The active length refers to the BHE length below the groundwater level. The part above the groundwater level makes no contribution to heat transfer and is therefore not considered. The undisturbed ground temperature is the mean temperature over the active part of the borehole and includes the geothermal gradient effect, as suggested by Eskilson (1987).

Design considerations and simulation procedure

Designing and sizing a DGCS entails a comprehensive design strategy, considering the design requirements for the borehole system and the building cooling system. This section gives an overview of the design considerations used for designing the DGCS.

Initial considerations

The reference building is equipped with a chiller and an ACB system with a design water supply temperature of 17°C . The possibility of increasing the water supply temperature would be an advantage when applying a DGCS. However, this would require increasing the ACB coil length to keep the cooling capacity of the beams unchanged.

Figure 3 plots the required length for the ACBs' coil versus the maximum borehole outlet temperature for the reference building. The building's cooling load and the set-point temperature for the zones are similar for all the cases investigated. The required borehole length decreases with the increase in the maximum borehole temperature. This is due to the fact that a given heat rejection peak to the ground causes a higher increase in the outlet temperature with shorter boreholes than with longer boreholes. Therefore, it is possible to have shorter boreholes and get the same room temperature if the ACB design is performed accordingly.

While deciding on the temperature levels of the system, condensation risk needs to be taken into account. A common strategy to prevent condensation on the ACB coil surface is to keep the beams' supply water temperature at least 1°C above the indoor air dew point. Nevertheless, the condensation risk is less relevant when designing for high-temperature cooling systems. Previous experiences in utilizing high-temperature chilled water for ACB systems show the possibility of running the system without any control provisions for condensation (Filipsson et al. 2020; Maccarini et al. 2017, 2020).

It is important to note that the results shown in Figure 3 are only intended to give a rough estimation of sizing the system. Other design parameters need to be considered as well. For instance, the specific heat extraction rate per borehole length is 65 W/m for a maximum outlet temperature of 17°C . A further increase of the borehole length by decreasing the outlet temperature might only be applicable in places with high ground thermal conductivity ($>3.0 \text{ W/m-K}$) (Rosén et al. 2001; VDI 2019). Moreover, changing the length and/or the number of the beams should be considered together with other renovation measures (i.e., if the renovation is carried out because the office space is to be adapted for another tenant). However, this study does not include changing the existing terminal units. Therefore, the cooling system design is carried out based on the existing ACB system with a maximum borehole outlet fluid temperature of 16°C . Given that the supply water temperature to the ACBs is 17°C , 1 K is considered to represent the losses over the heat exchanger between the building and the ground loops.

Simulation procedure and criteria

Simulations have been performed to assess and quantify the influence of the renovation measures on the sizing of the DGCS. The reference building is taken as the primary case study. The BHEs are sized to keep the fluid temperature leaving the boreholes below 16.0°C and above 2.0°C . The maximum temperature limit is considered based on the building's peak hourly cooling loads and the design of the existing ACB system. The dehumidification loads are not considerable in Gothenburg and hence are not decisive in sizing the BHEs. The minimum temperature limit is chosen to avoid the freezing of water in the building loop. The minimum temperature for the fluid entering the boreholes is 0°C . While a lower temperature limit causes the groundwater to freeze, choosing a higher temperature limit shortens the operation period of the preheating system. When the inlet fluid temperature approaches 0°C , the mixing valve diverts the fluid flow to the boreholes and the flow to the brine-to-air heat exchangers is shut off (see Figure 2).

The simulation process for sizing the boreholes is shown schematically in Figure 4. The preliminary simulation starts by substituting the input design parameters for the building, cooling system, ground, and the borehole. There are two inner iterative loops to check the convergence of the temperatures of the fluid entering and leaving the borehole. The required length of the borehole is iteratively adjusted to get the targeted borehole fluid temperatures. The borehole length

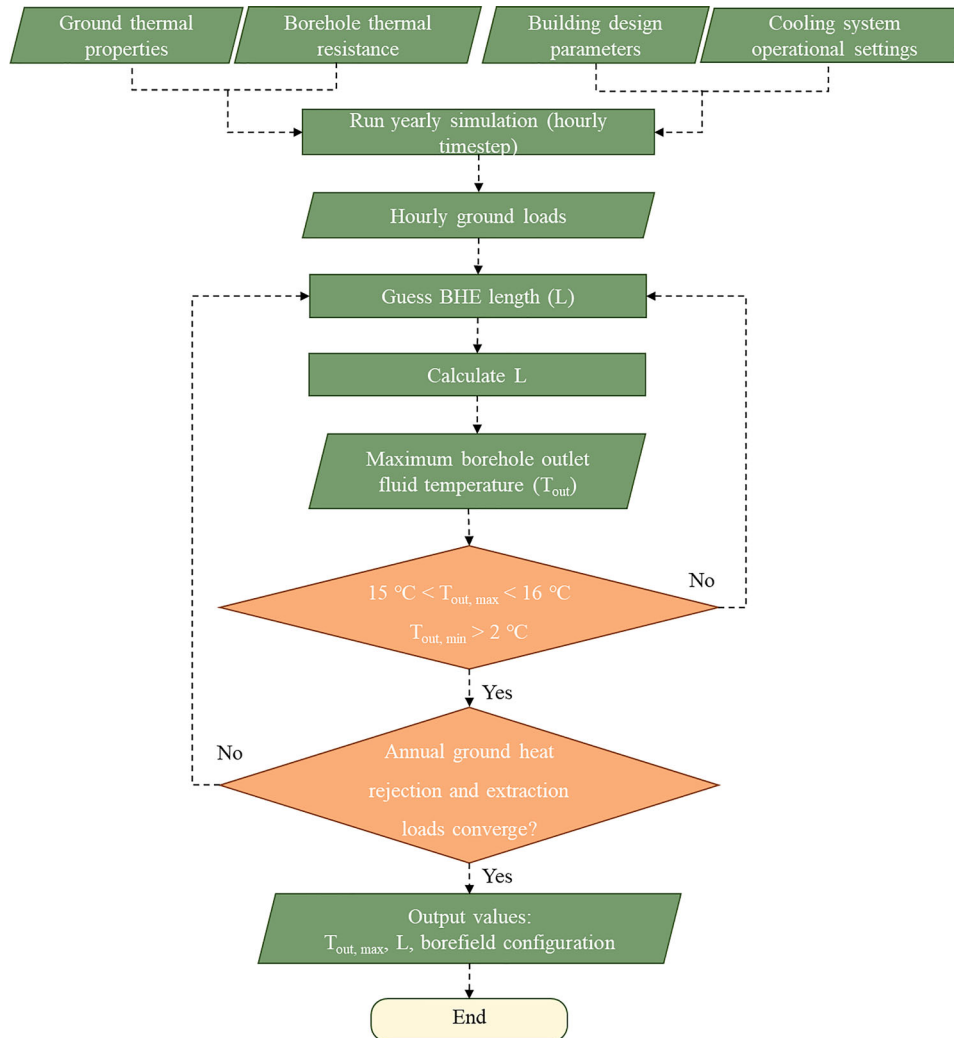

Fig. 4. Flow chart of the simulation process. “ $T_{sup, min}$ ” is the minimum supply water temperature to the ACBs and “ T_{out} ” is borehole outlet fluid temperature.

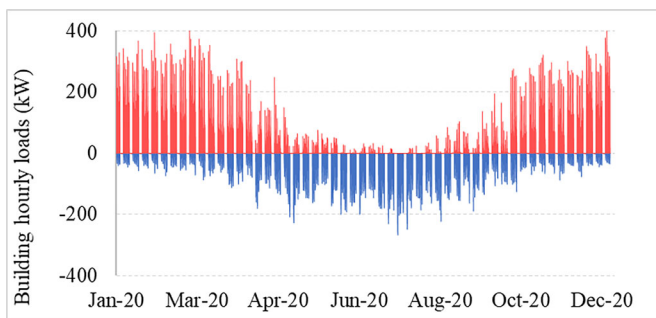

Fig. 5. Hourly cooling and heating loads profile for the reference building used for the preliminary design. The loads represent the heating or cooling provided by the sources.

is kept between 200 and 300 m, as is the common practice in Sweden. The outputs of the simulations are the borehole fluid inlet and outlet temperatures and the flow rate and the boreholes’ lengths.

Results

This section first discusses the energy simulation results for the reference building with the chiller, as these are used to design the borehole system in the following sections. The chiller is then replaced with the DGCS, and the required borehole length is simulated with the individual renovation measures in a parametric study. Next, the reference building with the DGCS is simulated with the combined renovation measures, and the borehole length is determined. Finally, the building’s energy demands before and after the measures are implemented are discussed.

Reference building

Figure 5 shows the hourly heating and cooling loads provided by the district heating and the chiller. Heating and cooling loads are designated by positive and negative values, respectively. While cooling is needed throughout the year, demand is high in summer and low in winter. Cooling demand during the winter period is mostly required for the

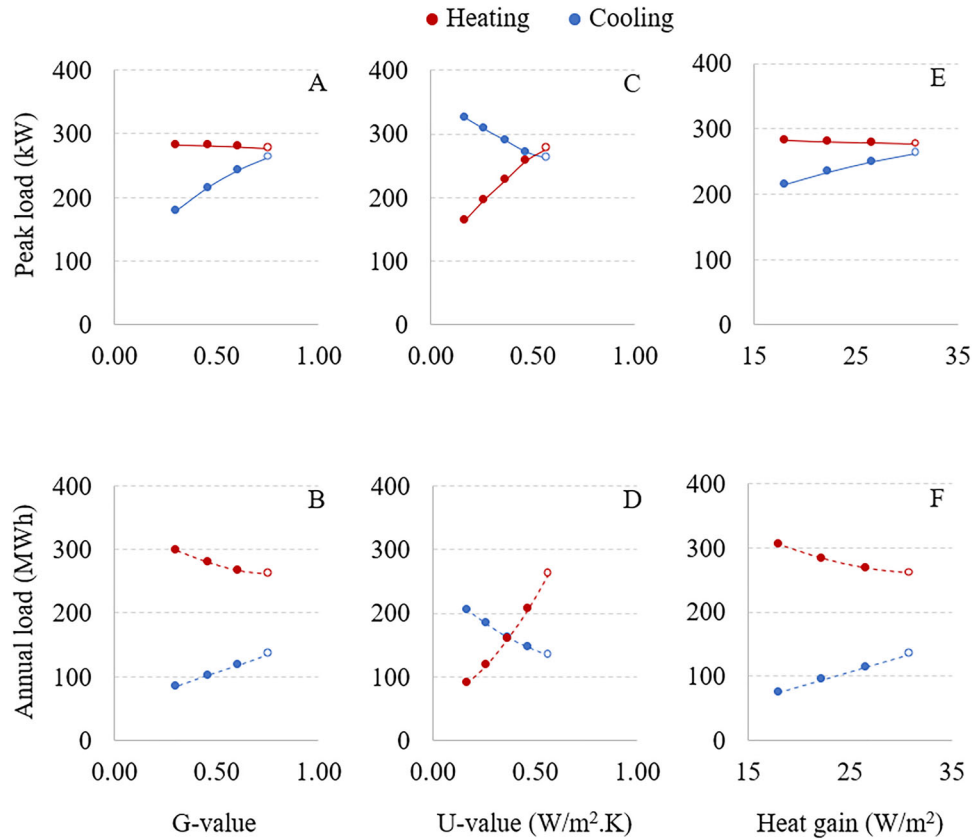

Fig. 6. Peak and annual heating and cooling loads for different (A–B) windows’ G-values, (C–D) envelope U-values, and (E–F) internal heat gains. The loads are calculated based on the fluid leaving and entering the sources (ground and district heating system). Values for the reference building are designated with empty marks.

central zone to remove the internal gains generated by the plug loads and the occupancy. The peak hourly and the annual cooling loads are 262.5 kW and 134 MWh, respectively. Note that the building’s cooling demand is provided in part by the chiller and in part by the outdoor air, through the ventilation air. The ventilation cooling demand is not shown in the figure.

The reference building is a heating-dominated building with an annual heating demand of 260 MWh. The heating demand is provided by the district heating system and it includes the heat delivered to the ventilation air and the supply water to the radiators. Space heating is off between June and August. However, air heating is still needed to maintain the ventilation air temperature if the outdoor air temperature falls below 20 °C.

Individual measures and borehole sizing

The reference building uses an electrically driven chiller to cool the working fluid. To replace the chiller with a DGCS, the influence of each renovation measure, one at a time, is quantified in terms of the peak hourly ground loads, the annual ground loads, and the required borehole length. The peak and the annual cooling loads shown in this section only concern the ground cooling loads and the cooling provided by the outdoor air is not included, unless otherwise

mentioned. Moreover, both heating and cooling loads (peak and annual) refer to the plant loads and not the space loads.

Building design measures

The windows’ G-value determines the intensity of the solar radiation entering the space. The results in Figure 6A shows that G-value greatly affects the peak cooling load but has a marginal effect on the peak heating load. This is because peak heating loads happen in the absence of direct solar radiation and the G-value does not play a role in changing the peak intensity. Therefore, the results suggest that changing the G-value has almost no impact on sizing the heating terminal units. Unlike the peak loads, Figure 6B shows a trade-off between the annual heating and cooling loads. G-value influences the annual loads almost equally, but it has different consequences for the system design. Reducing the G-value increases the heating demand and thus the amount of heating energy purchased from the district heating network. Since cooling is provided from a free source, decreasing the G-value has no influence on the energy costs. Nevertheless, it still has considerable impacts on sizing the boreholes and the associated costs. The results are further elaborated in the discussion section.

The building’s envelope U-value affects both the cooling and heating demands of the building, as it changes transmission heat losses from the building (Figure 6C and 6D). However, it has a greater influence on the heating demand

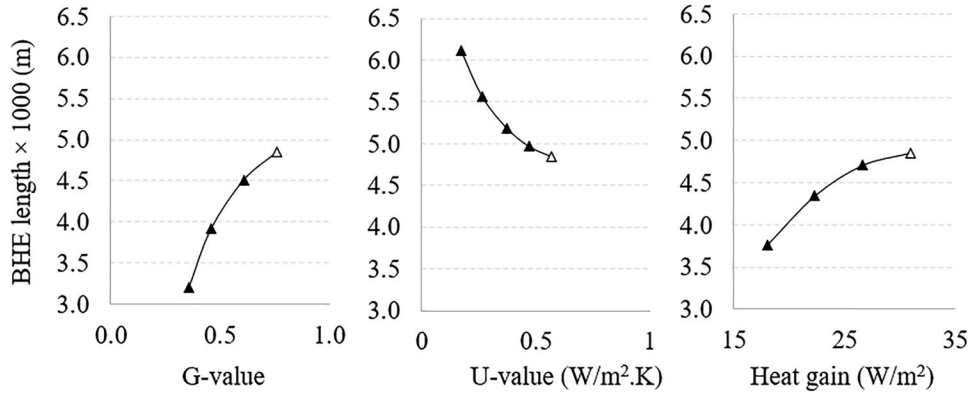

Fig. 7. The total required borehole length for different windows' G-values, envelope U-values, and internal heat gains. Values for the reference building are designated with empty marks.

characteristics (peak and annual demand) than on the cooling demand. This is because heating loads are highly dependent on heat transmission losses, whereas cooling loads are mainly influenced by heat gains (internal and external).

Internal heat gains constantly heat the zones between 08:00 and 17:00. Decreasing the internal gains significantly decreases the peak and the annual cooling loads (Figure 6E and F). Conversely, decreasing the internal gains only slightly (~ 0.02) increases the peak heating loads. This is because the heating peaks occur in early mornings, when occupancy and other internal heat sources start releasing heat into the space.

Figure 7 shows the required borehole length as a consequence of adjusting the building design measures shown in Figure 6. Note that only cooling loads (peak and annual) are effective in sizing the boreholes, as the heating demand is provided by another source (district heating).

The results show that the G-value has the highest impact on the required borehole length. Both the peak and the annual loads undergo significant changes as the G-value varies. Reducing the G-value from 0.76 to 0.30 results in a reduction of the cooling peak loads by 31% and a reduction of the annual loads by 37%, contributing to a reduction in the borehole length of approximately 35% (from 4900 m to 3200 m).

Cooling system operational measures

Changing the set-point temperature for the cooling system has different consequences for the building's heating and cooling demands. Increasing the set-point temperature over the range of 22 to 26 °C slightly decreases the peak load by 18% but greatly decreases the annual load by 72% (Figure 8A and 8B). This can be mainly related to the geometry of the building, having a large interior zone with substantial internal gains and small perimeter zones. Increasing the set-point reduces the peak hourly loads of the perimeter zones but does not affect the peak intensity of the interior zone. On the other hand, as the interior zone requires year-round cooling, changing the set-point strongly influences the annual cooling load.

Although the room set-point temperature for the heating system is constant at 21 °C, changing the cooling system set-point turns out to be effective on the heating loads (Figure 8A and 8B). Due to the internal heat gains, the interior zone always requires cooling, and thus the indoor temperature follows the cooling set-point. As the cooling set-point is higher than the heating set-point, the interior zone heats up the exterior zones and consequently influences their heating demand.

The chosen room temperature range provides acceptable thermal comfort (ASHRAE 2004; ISO 2014). However, occupants experience different thermal comfort levels depending on the room temperature. While the range 24.5 ± 0.5 °C is closely associated with a neutral thermal sensation for the occupants, 26 °C and 22 °C may be perceived as slightly warm and slightly cool by the occupants, respectively.

Figure 8C and 8D plot the peak and the annual heating and cooling loads versus the night cooling airflow rates. The night cooling ventilation only operates between June and August. Therefore, it has no influence on the heating demand.

Parametric sensitivity of the required borehole length to the cooling system set-point temperature and the night cooling airflow rates is shown in Figure 9. Increasing the cooling set-point temperature over the range from 22 to 26 °C decreases the required borehole length by 782 m. Incorporating night cooling has a marginal influence of about 10% in reducing the required borehole length.

Comparing the results shown in Figure 7 and Figure 9 shows that reducing the G-value represents the highest decrease in the peak loads and the required length for the boreholes. Furthermore, reducing the room temperature set-point results in the highest reduction in the annual ground heat rejection loads.

Combined measures and borehole sizing

Figure 10A shows the hourly ground heat rejection loads on the design day for the renovated building and the reference building equipped with the DGCS (Ref-DGCS). In the Ref-DGCS case, the ground loads rise rapidly in the morning

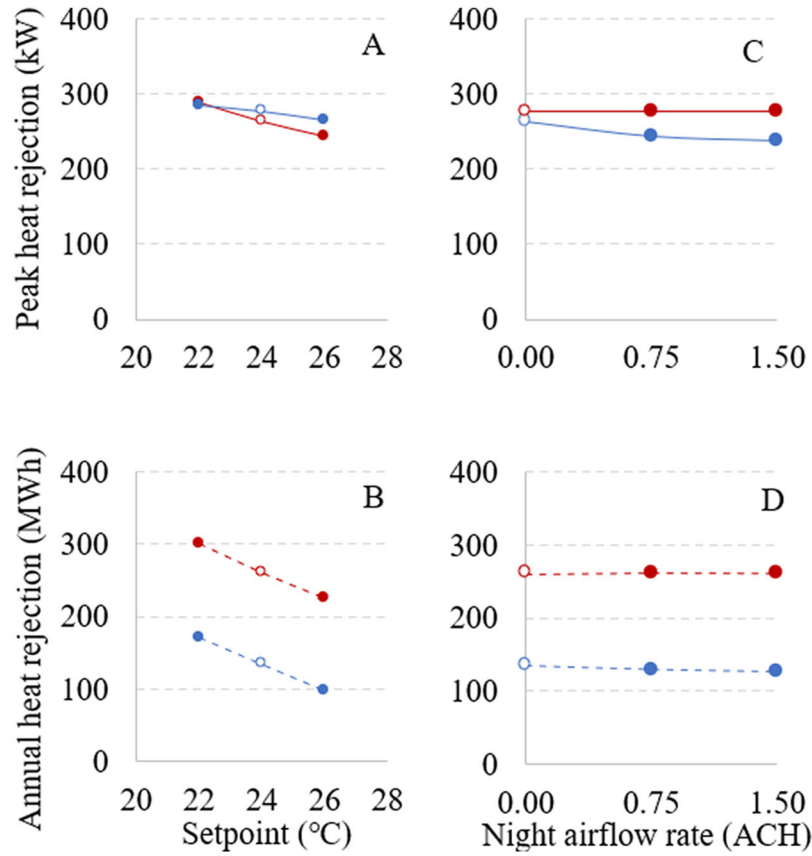

Fig. 8. Peak and annual heating and cooling loads for different (A–B) cooling system set-points and (C–D) night cooling airflow rates. The loads are calculated based on the fluid leaving and entering the sources (ground and district heating system). Values for the reference building are designated with empty marks.

and level off at a peak value around midday. For the renovated building, the ground loads are significantly smaller and rise slowly toward a peak in the late afternoon. The difference in the morning load's trend is due to the application of windows with smaller G-value and lower internal heat gain intensity. Both parameters reduce the accumulated heat in the building structure from the previous day. Note that no night cooling is used for the "Ref-DGCS" case. The results show a reduction of about 48% (from 262 kW to 126 kW) in the ground peak heat rejection load.

Further analysis of the building energy balance shows that renovating the building has changed the hourly maximum heat gain's composition on the design day. In the reference building, heat gain from the internal sources and solar radiation account for 54% and 46% of the maximum hourly heat gain, respectively. After performing the renovation, solar radiation makes the largest contribution ($\sim 59\%$) to the hourly maximum heat gain. Conductive heat gain from the building envelope for both cases makes no contribution to the maximum heat gain because the outdoor temperature is below the room temperature.

The annual ground heat rejection loads are shown in Figure 10B. Implementing the renovation measures offers a substantial reduction of about 69% in the annual ground loads. This substantial reduction makes it possible to remove

the dry cooler and to balance the ground loads by preheating the primary air in the air handling unit. This directly reduces the cooling system's electricity demand.

Figure 11 shows the configuration and total length of the BHEs for the Ref-DGCS and the renovated cases. The total required borehole length for the renovated building is 2160 m and is reduced by 56% compared to the Ref-DGCS building. A further analysis of the single measures used in the renovation package shows that the G-value makes a major contribution to reducing the required borehole length.

Figure 12 represents the fluid temperature leaving the borehole over 1 year of operation. Each central box of the boxplot presents the interquartile range, with a horizontal line at the median and the lower and the upper quartiles representing the 25th and 75th quartiles at the bottom and the top of each box. The whiskers define extra quartile values and the dot symbols represent outliers.

Figure 12 also shows that the median outlet temperature for both cases is approximately equal to the undisturbed temperature of 8.3°C . This indicates that the ground system is thermally balanced over the years of its operation. What causes the fluid temperature to become lower than the undisturbed ground temperature is the cooling of the borehole fluid in the air handling unit and in the dry cooler.

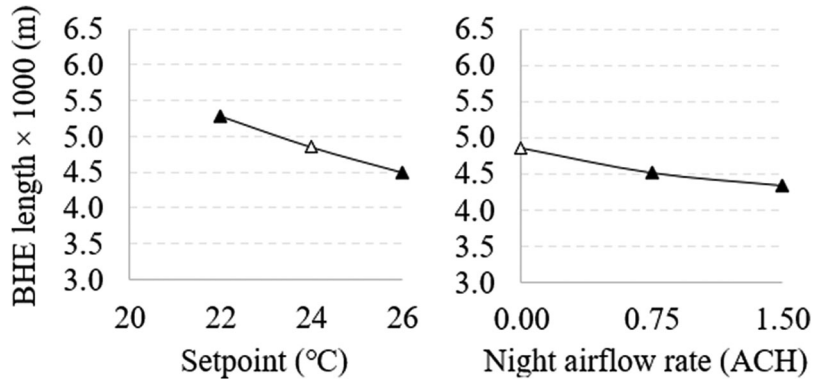

Fig. 9. The required total borehole length for different cooling system set-points and night cooling airflow rates. Values for the reference building are designated with empty marks.

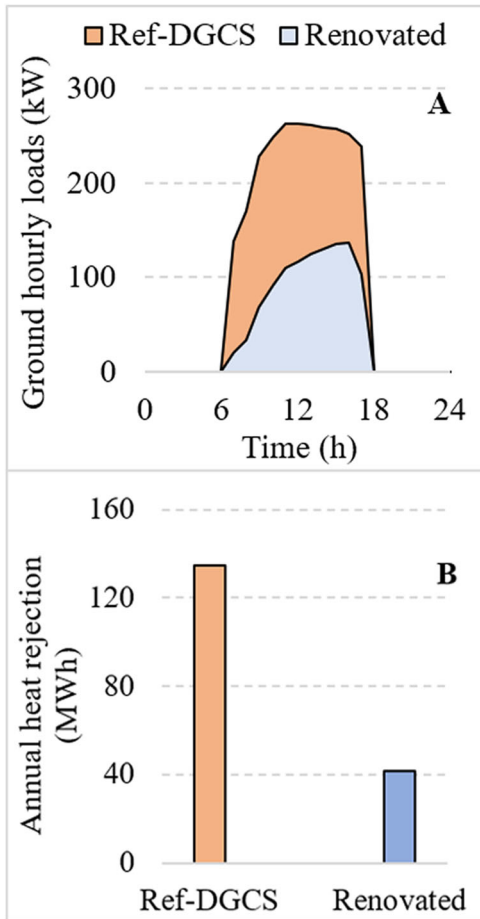

Fig. 10. (A) Hourly ground heat rejection loads on the design day and (B) the annual heat rejection loads for the reference building equipped with the DGCS (Ref-DGCS) and the renovated building.

Although the maximum outlet temperature is similar for both cases, the temperature enclosed by the upper whisker is lower for the renovated building. In fact, the outliers extend the outlet temperature from the upper whisker at 12.7 °C to the maximum

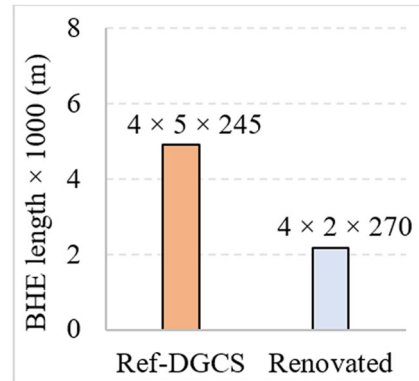

Fig. 11. Total required borehole length and borehole configuration for the renovated building and the reference building equipped with the DGCS (Ref-DGCS).

temperature of about 16 °C. The outliers are formed by the peak hourly loads. This means that the borehole design for the renovated building is sensitive to the daily peaks.

Building energy demand analysis

Building energy demand can be defined and analyzed in several ways, depending on the focus of the study. In this section, the terminologies used to describe the building’s energy demand are “building energy use” and “building purchased energy.” Building energy use is the total energy input to the technical building systems to fulfill the energy need for space heating, space cooling, and ventilation. In other words, building energy use is the sum of the electrical, thermal, and recovered energies supplied to the technical systems. Purchased energy is defined as the energy supplied from the grid to heat, cool, and distribute the working fluid (air and water). Auxiliary energy includes the purchased electrical energy to power the fans and pumps for the heating and the cooling systems. By definition, purchased energies in this study are electricity from the grid and heating from the district heating network.

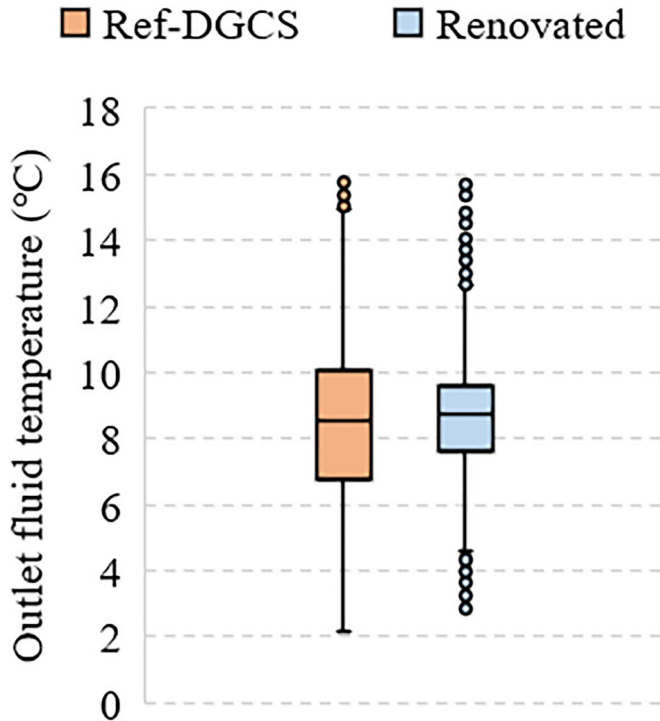

Fig. 12. Borehole outlet fluid temperature for the renovated building and the reference building equipped with the DGCS (Ref-DGCS). The undisturbed ground temperature is 8.3 °C.

Figure 13 compares the annual building delivered energy before and after the renovation measures were implemented. The ground cooling deals with the annual heat rejection loads to the ground for cooling the building. Ambient air cooling represents the free cooling provided by the outdoor air when the outdoor temperature is below 20 °C, that is, the primary air temperature supplied to the beams. The electricity demand is the sum of the electrical energy used to power the chiller (if included) and the pumps and fans for heating and cooling applications.

Replacing the chiller with the DGCS results in a significant reduction in the annual electricity demand, by about 81%. The electricity demand is further reduced from 3.3 kWh/m²-y to 2.4 kWh/m²-y after applying the renovation measures. This reduction is achieved because the balance in the ground loads can be achieved without the use of the dry cooler, as previously discussed.

Figure 14 shows the building's purchased energy demand before and after the renovations. The reference building has the highest purchased energy demand. The system purchases heating energy for space heating and electricity for space cooling and running the pumps and fans. The purchased energy is reduced by about 22% (14.1 kWh/m²-y) by replacing the chiller with the DGCS. A further reduction in heating energy as well as in the electrical energy is achieved by applying the renovation measures. The total reduction in the purchased energy after performing the renovations is approximately 49% compared to the reference building.

The seasonal performance factor (SPF) can be a useful parameter for evaluating the performance of the cooling

system. SPF for the ground system (SPF_{DGCS}) is calculated by dividing the annual ground heat rejection loads by the annual electricity for the circulation pumps and the fan installed in the dry cooler. The SPF_{DGCS} values for the renovated and the reference building with the DGCS are 71 and 23, respectively. The SPF for the renovated building is higher because the ground loads can be balanced without the aid of the dry cooler, resulting in a reduction of the fan's electricity use by about 3.8 MWh.

The SPF for the system (SPF_{system}) includes all the cooling delivered to the building by ventilation and ground divided by the electrical energy used (by fans in the air handling unit and the dry cooler, and all circulation pumps in the ground loop and the building loop). The SPF_{system} values for the renovated building and the reference building with the DGCS are 12 and 15, respectively. The lower SPF_{system} for the renovated building is due to the large percentage share of the ventilation cooling in overall cooling demand of the building (Figure 13). It is worth mentioning that the performance of the reference building with the chiller, which is commonly defined by the coefficient of performance (COP), is about 2.4.

Discussion

This study investigated two major renovation scenarios: utilizing the ground as the cooling source and applying selected renovation measures. Replacing the chiller with the DGCS significantly reduces electricity demand (by about 22%). However, it is not likely to meet the primary energy use targets of 60 kWh/m²-y and 70 kWh/m²-y often set as goals for comprehensive renovations in European and Swedish office buildings, respectively (Boverkett 2018; Shnapp et al. 2013). For a potential DGCS application, the maximum energy-saving benefits will be yielded when this is implemented together with building renovation. In that way, using the DGCS will be more cost-effective, because a much smaller borehole system will be required.

While a reasonable combination of renovation measures helps to reduce the borehole length and improve the system efficiency, applying inappropriate measures has adverse consequences. For instance, renovating the building envelope to reduce the heating losses is a common part of building energy renovation plans in cold climates (Bonakdar et al. 2017; Niemelä et al. 2017; Rose and Thomsen 2015). Results from the sensitivity analysis show that only reducing the reference building envelope U-value to 0.42 W/m²-K results in a borehole required length of 4970 m and SPF_{DGCS} of 23. In comparison, the renovated building as defined in Table 4 has a borehole length of 2160 m and SPF_{DGCS} of 71.

Thermal performance of the cooling system is in fact a question of definition. The SPF_{system}, comprised of both the ground and the ventilation systems, is mainly influenced by the ventilation cooling and the fan's electricity demand. Therefore, it does not seem to be an accurate measure to evaluate the performance of the DGCSs. SPF_{ground} is a better

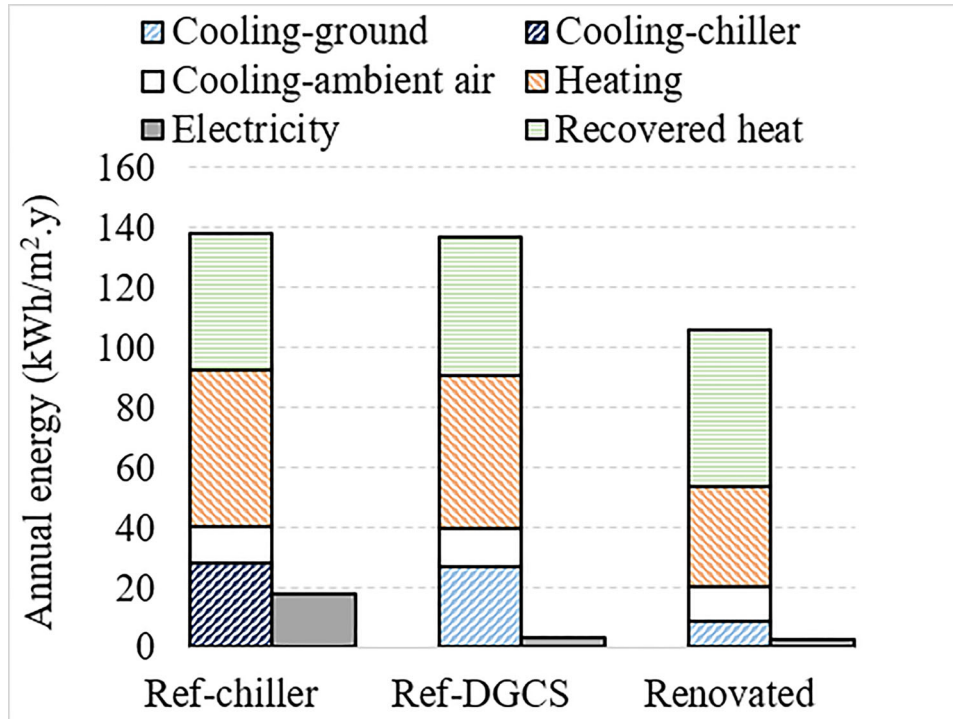

Fig. 13. Annual cooling, heating, and electricity energy for the reference building (Ref-chiller), the reference building equipped with the DGCS (Ref-DGCS), and the renovated building.

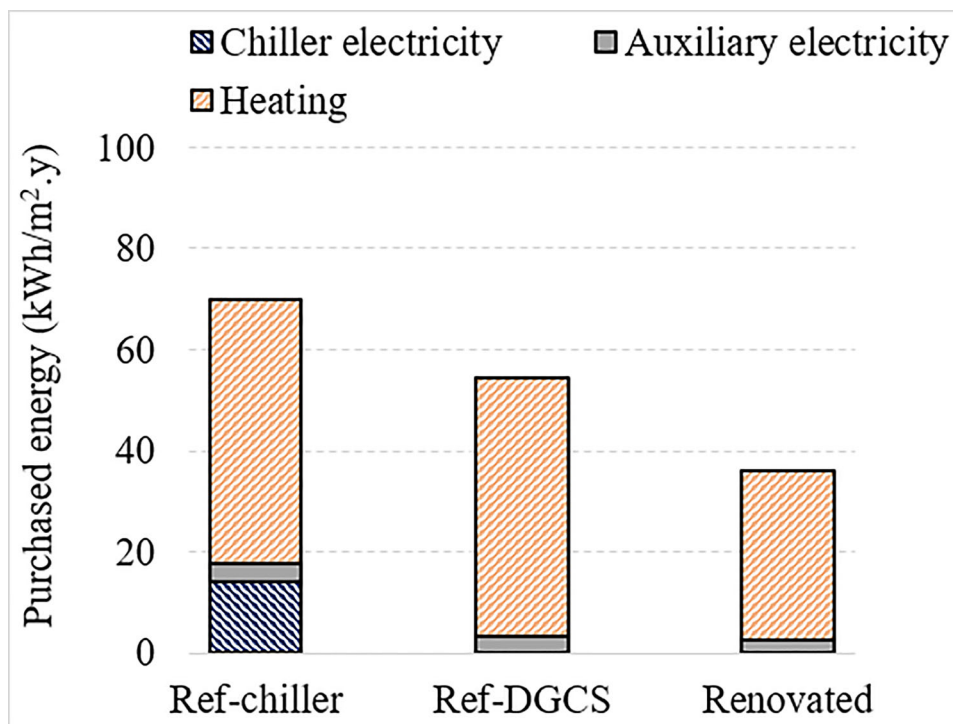

Fig. 14. Annual purchased energy use for the reference building (Ref-chiller), the reference building equipped with the DGCS (Ref-DGCS), and the renovated building.

measure to evaluate the performance of the DCGSs, as it considers the ground loads and the electricity use of only the components involved in the ground cooling (Spitler and Gehlin 2019).

Different renovation measures have been investigated in relation to sizing boreholes through their influence on the ground hourly and annual loads. To analyze which parameters yield smaller boreholes, we consider the building load profile.

In this study, G-value has the largest impact on the borehole sizing. This is despite the fact that the case building has a large interior zone and a medium window-to-wall ratio. It can be seen that the ground peak loads are significantly influenced by the G-values. Fast changes in the ground loads are not favorable to the borehole system due to the long time constant of the ground surrounding the boreholes (Pahud et al. 2012). Therefore, it can be suggested that the G-value would have a large impact on sizing the boreholes regardless of the building orientation and geometry. It is also possible to incorporate shading devices and/or reduce, to some extent, the glazing area to alleviate the consequences of solar radiation on the building peak load.

Cooling system set-point is shown to offer a high potential for reducing the building load in this study. However, its impact on the ground loads is found to be smaller than what has been reported in our previous studies (Arghand et al. 2021a, 2021c). It is likely that external and internal heat gain intensities can enhance or diminish the importance of the temperature set-points, as suggested by Spyropoulos and Balaras (2011).

Precooling is favorable for buildings with intermediate and high structural mass and for buildings with a high ratio of on-peak to off-peak rates (Henze et al. 2007). Therefore, whether every 1 kWh of electricity used for precooling has the same value in reducing the borehole size in this study is questionable.

Results from this study are applicable not only for existing buildings but also for under-design buildings. A major limitation for the ground-coupled systems, and particularly for DGCSs, is associated with their initial cost (Rees 2016). Besides the outcomes of the sensitivity study, the results suggest considering two general solutions to reduce the required borehole length when designing new buildings. First, designing the system and sizing the ACBs based on very high-temperature chilled water ($\sim 20^\circ\text{C}$) can significantly reduce the required borehole length. Although this would incur additional costs for purchasing larger and/or more ACBs, a much greater reduction in borehole drilling and installation costs can be expected. Second, a reasonable operation strategy is to precool the space, preferably at $20 - 22^\circ\text{C}$, and allow the room temperature to float within a certain range during occupancy, that is, 23 to 25°C . This operation strategy benefits the design of the system by reducing the peak daily ground loads and hence the required borehole length. This operation strategy was previously investigated by Arghand et al. (2021a) and successfully established acceptable thermal comfort for the occupants when used in practice (Filipsson et al. 2020; Maccarini et al. 2020).

Conclusions

DGCS is an emerging technology in Sweden, commonly used for new office buildings. The purpose of this study was to evaluate the energy-saving possibilities of a DGCS instead of using a chiller for an existing office building.

Moreover, possible choices of renovation measures are applied to the building, and the results are evaluated in terms of borehole design and building energy demand. The measures being investigated were the envelope U-value, the windows' G-value, internal gains intensity, room temperature set-point, and precooling strategies. The major findings are summarized as follows:

- Cooling the building by using the DGCS instead of the chiller reduced the total purchased energy by 22% (from $70\text{ kWh/m}^2\text{-y}$ to $55\text{ kWh/m}^2\text{-y}$) by eliminating the chiller's electricity demand.
- Implementing the selected renovation measures to the building equipped with the DGCS further reduced the purchased energy by 34% (from $55\text{ kWh/m}^2\text{-y}$ to $36\text{ kWh/m}^2\text{-y}$) by decreasing the thermal losses and the building's cooling demand.
- To exploit the potential of using the DGCSs to the fullest for the existing buildings, implementing the renovation measures should be part of the renovation plan. Given the simulations performed in this study, the total required borehole length decreased from 4900 m to 2160 m. The borehole length could be reduced even further if the existing ACBs can be replaced and redesigned for higher supply water temperatures.
- Changing the windows' G-value showed the highest influence in reducing the ground heat rejection loads and hence the required borehole length. On the other hand, U-value had an inversely nonlinear correlation with the required borehole length.
- For the renovated building and the reference building equipped with the DGCS, the SPF values of the DGCS were 71 and 23, respectively. Implementing the renovation measures not only decreased the building's cooling demand but also enabled a balancing of the ground loads without using the dry cooler, resulting in a higher SPF.

Declaration of interests

We declare that we have no financial and personal relationships with other people or organizations that can inappropriately influence the authors' work.

Funding

This work was financially supported by the Swedish Energy Agency (Energimyndigheten) through its E2B2 national research program.

ORCID

Taha Arghand  <http://orcid.org/0000-0002-5911-9773>
 Saqib Javed  <http://orcid.org/0000-0001-9629-9382>
 Jan-olof Dalenbäck  <http://orcid.org/0000-0001-8771-0416>

References

- Arghand, T. 2019. Direct-ground cooling systems for office buildings: Design and control considerations. Licenciate thesis, Chalmers University of Technology.
- Arghand, T., S. Javed, A. Trüschel, and J.-O. O. Dalenbäck. 2021a. Influence of system operation on the design and performance of a direct ground-coupled cooling system. *Energy and Buildings* 234: 110709. doi:10.1016/j.enbuild.2020.110709
- Arghand, T., S. Javed, A. Trüschel, and J. Dalenbäck. 2019. Control methods for a direct-ground cooling system : An experimental study on office cooling with ground-coupled ceiling cooling panels. *Energy and Buildings* 197:47–56. doi:10.1016/j.enbuild.2019.05.049
- Arghand, T., S. Javed, A. Trüschel, and J. Dalenbäck. 2021b. A comparative study on borehole heat exchanger size for direct ground coupled cooling systems using active chilled beams and TABS. *Energy and Buildings* 110874. doi:10.1016/j.enbuild.2021.110874
- Arghand, T., S. Javed, A. Trüschel, and J. O. Dalenbäck. 2021c. Cooling of office buildings in cold climates using direct ground-coupled active chilled beams. *Renewable Energy* 164:122–32. doi:10.1016/j.renene.2020.09.066
- ASHRAE. 2004. *ASHRAE standard 55: Thermal environmental conditions for human occupancy*. Atlanta: ASHRAE.
- ASHRAE. 2013. *ASHRAE handbook - HVAC fundamentals*. Atlanta: American Society of Heating, Refrigerating and Air-conditioning Engineers.
- ASHRAE. 2017. Nonresidential cooling and heating. In *ASHRAE handbook of fundamentals*, 18.1–66. Atlanta: American Society of Heating, Refrigerating and Air-conditioning Engineers.
- BELOK. 2015. *Immemiljökraav för lokalbyggnader*. Gothenburg, Sweden: The client group for premises (BELOK).
- Bonakdar, F., A. S. Kalagasidis, and K. Mahapatra. 2017. The implications of climate zones on the cost-optimal level and cost-effectiveness of building envelope energy renovation and space heat demand reduction. *Buildings* 7 (4):39. doi:10.3390/buildings7020039
- Boverket. 2018. *Boverkets mandatory provisions and general recommendations, BBR*, Vol. 1. Kalskrona, Sweden: National Board of Housing (Boverket).
- CEN. 2019. *EN 16798: Energy Indoor environmental input parameters for design and assessment of energy performance of buildings addressing indoor air quality, thermal environment, lighting and acoustics*. Brussels, Belgium: European Committee for Standardization (CEN).
- De Boeck, L., S. Verbeke, A. Audenaert, and L. De Mesmaeker. 2015. Improving the energy performance of residential buildings: A literature review. *Renewable and Sustainable Energy Reviews* 52: 960–75. doi:10.1016/j.rser.2015.07.037
- Deru, M., K. Field, D. Studer, K. Benne, B. Griffith, P. Torcellini, B. Liu, M. Halverson, D. Winiarski, M. Rosenberg, et al. 2011. *U.S. Department of Energy commercial reference building models of the national building stock*. National laboratory of the U.S. Department of Energy. Colorado: National Renewable Energy Laboratory.
- Eicker, U., and C. Vorschulze. 2009. Potential of geothermal heat exchangers for office building climatisation. *Renewable Energy* 34 (4):1126–33. doi:10.1016/j.renene.2008.06.019
- EQUA Simulation Technology Group. 2010. *Technical report: Validation of IDA indoor climate and energy 4.0 build 4 with respect to ANSI/ASHRAE Standard 140-2004*. EQUA Simulation Technology Group, Sweden. Stockholm, Sweden: EQUA Simulation Technology Group.
- EQUA Simulation Technology Group. 2014. *User guide: Borehole 1.0*. Stockholm, Sweden: EQUA Simulation Technology Group.
- EQUA Simulation Technology Group. 2018. *User manual- IDA indoor climate and energy version 4.8*. Stockholm, Sweden: EQUA Simulation Technology Group.
- Eriksson, L., and P. Skogqvist. 2017. *Description of the IDA ICE borehole model, Internal Report*. Stockholm, Sweden: EQUA Simulation Technology Group.
- Eskilson, P. 1987. *Thermal analysis of heat extraction boreholes*. PhD thesis, Department of Mathematical Physics, University of Lund.
- EU Building Stock Observatory. 2016. EU buildings database.
- Filipsson, P., A. Trüschel, J. Gräslund, and J.-O. Dalenbäck. 2017. A thermal model of an active chilled beam. *Energy and Buildings* 149:83–90. doi:10.1016/j.enbuild.2017.05.032
- Filipsson, P., A. Trüschel, J. Gräslund, and J. Dalenbäck. 2020. Performance evaluation of a direct ground-coupled self-regulating active chilled beam system. *Energy and Buildings* 209:109691. doi:10.1016/j.enbuild.2019.109691
- Gram-Hanssen, K. 2014. Existing buildings - Users, renovations and energy policy. *Renewable Energy* 61:136–40. doi:10.1016/j.renene.2013.05.004
- Gustafsson, M. 2017. *Energy efficient renovation strategies for Swedish and Other European Residential and Office Buildings*. Stockholm, Sweden: KTH Royal Institute of Technology.
- Haase, M., K. Buvik, T. H. Dokka, and I. Andresen. 2011. Design guidelines for energy efficiency concepts in office buildings in Norway. *Design Principles and Practices* 5 (4):667–94.
- Henze, G. P., T. H. Le, A. R. Florita, and C. Felsmann. 2007. Sensitivity analysis of optimal building thermal mass control. *Journal of Solar Energy Engineering* 129 (4):473–85. doi:10.1115/1.2770755
- ISO. 2014. *ISO 7730- Ergonomics of the thermal environment – Analytical determination and interpretation of thermal comfort using calculation of the PMV and PPD indices and local thermal comfort criteria*. Brussels: International Organization for Standardization.
- Javed, S. 2010. *Design of ground source heat pump systems: Thermal modelling and evaluation of boreholes*. Gothenburg, Sweden: Chalmers University of Technology.
- Javed, S., I. R. Ørnes, M. Myrup, and T. H. Dokka. 2018. Design optimization of the borehole system for a plus-Energy kindergarten in Oslo. *Architectural Engineering and Design Management* 15 (3):181–95. doi:10.1080/17452007.2018.1555088
- Jensen, P. A., and E. Maslesa. 2015. Value based building renovation - A tool for decision-making and evaluation. *Building and Environment* 92:1–9. doi:10.1016/j.buildenv.2015.04.008
- Jradi, M., C. Veje, and B. N. Jørgensen. 2017. Deep energy renovation of the Maersk office building in Denmark using a holistic design approach. *Energy and Buildings* 151 (2017):306–19. doi:10.1016/j.enbuild.2017.06.047
- Kotteck, M., J. Grieser, C. Beck, B. Rudolf, and F. Rubel. 2006. World map of the Köppen-Geiger climate classification updated. *Meteorologische Zeitschrift* 15 (3):259–63. doi:10.1127/0941-2948/2006/0130
- Kropf, S. and G. Zweifel. 2001. *Validation of the Building Simulation Program IDA-ICE According to CEN 13791 "Thermal Performance of Buildings - Calculation of Internal Temperatures of a Room in Summer Without Mechanical Cooling - General Criteria and Validation Procedures"*. Lucerne University of Applied Sciences and Arts. Luzern, Switzerland: Lucerne University of Applied Sciences and Arts.
- Kurnitski, J. 2012. nZEB office building Ympäristöäly in Helsinki, Finland. *The REHVA European HVAC Journal* 49 (2):44–9.
- Maccarini, A., G. Hultmark, N. C. Bergsøe, K. Rupnik, and A. Afshari. 2020. Field study of a self-regulating active beam system for simultaneous heating and cooling of office buildings. *Energy and Buildings* 224:110223. doi:10.1016/j.enbuild.2020.110223
- Maccarini, A., M. Wetter, A. Afshari, G. Hultmark, N. C. Bergsøe, and A. Vorre. 2017. Energy saving potential of a two-pipe system for

- simultaneous heating and cooling of office buildings. *Energy and Buildings* 134:234–47. doi:10.1016/j.enbuild.2016.10.051
- Man, Y., H. Yang, Y. Qu, and Z. Fang. 2015. Feasibility investigation of the low energy consumption cooling mode with ground heat exchanger and terminal radiator. *Procedia Engineering* 121:423–9. doi:10.1016/j.proeng.2015.08.1088
- Moosberger, S. 2007. Report: IDA ICE CIBSE-validation: Test of IDA indoor climate and energy version 4.0 according to CIBSE TM33, issue 3. Lucerne University of Applied Sciences and Arts. Luzern, Switzerland: Lucerne University of Applied Sciences and Arts.
- Niemelä, T., R. Kosonen, and J. Jokisalo. 2017. Cost-effectiveness of energy performance renovation measures in Finnish brick apartment buildings. *Energy and Buildings* 137:60–75. doi:10.1016/j.enbuild.2016.12.031
- Østergård, T., R. L. Jensen, and S. E. Maagaard. 2017. Early building design: Informed decision-making by exploring multidimensional design space using sensitivity analysis. *Energy and Buildings* 142: 8–22. doi:10.1016/j.enbuild.2017.02.059
- Pahud, D., M. Belliardi, and P. Caputo. 2012. Geocooling potential of borehole heat exchangers' systems applied to low energy office buildings. *Renewable Energy*. 45:197–204. doi:10.1016/j.renene.2012.03.008
- Rees, S. J. 2016. *Advances in ground-source heat pump systems. Advances In Ground-Source Heat Pump Systems*. Duxford, UK: Woodhead Publishing.
- Romaní, J., L. F. Cabeza, P. Gabriel, A. Laura, and A. De Gracia. 2018. Experimental testing of cooling internal loads with a radiant wall. *Renewable Energy* 116:1–8. doi:10.1016/j.renene.2017.09.051
- Romaní, J., G. Pérez, and A. de Gracia. 2016. Experimental evaluation of a cooling radiant wall coupled to a ground heat exchanger. *Energy and Buildings* 129:484–90. doi:10.1016/j.enbuild.2016.08.028
- Rose, J., and K. E. Thomsen. 2015. Energy saving potential in retrofitting of non-residential buildings in Denmark. *Energy Procedia* 78:1009–14. doi:10.1016/j.egypro.2015.11.047
- Rosén, B., A. Gabriellsson, J. A. N. Fallsvik, G. Hellström, and G. Nilsson. 2001. *System för värme och kyla ur mark - En nulägesbeskrivning*. Linköping, Sweden: Swedish Geotechnical Institute (SGI).
- Shnapp, S., R. Sitjà, and J. Laustsen. 2013. *What is a deep renovation definition?* Paris, France: Global Buildings Performance Network (GBPN).
- Spitler, J. D., and S. Gehlin. 2019. Measured performance of a mixed-use commercial-building ground source heat pump system in Sweden. *Energies* 12 (10):2020. doi:10.3390/en12102020
- Spitler, J. D., S. Javed, and R. K. Ramstad. 2016. Natural convection in groundwater-filled boreholes used as ground heat exchangers. *Applied Energy* 164:352–65. doi:10.1016/j.apenergy.2015.11.041
- Spyropoulos, G. N., and C. A. Balaras. 2011. Energy consumption and the potential of energy savings in Hellenic office buildings used as bank branches - A case study. *Energy and Buildings* 43 (4): 770–8. doi:10.1016/j.enbuild.2010.12.015
- Swedish Work Environment Authority. 2009. *Workplace design-Provisions of the Swedish Work Environment Authority on workplace design (AFS 2009:2). Arbetsmiljöverket*. Stockholm, Sweden: Arbetsmiljöverket.
- VDI. 2019. *VDI 4640- PART 2: Thermal use of the underground - Ground source heat pump systems*. Dusseldorf, Germany: The Association of German Engineers (VDI).
- Yildiz, Y., K. Korkmaz, T. Göksal Özbalta, and Z. Durmus Arsan. 2012. An approach for developing sensitive design parameter guidelines to reduce the energy requirements of low-rise apartment buildings. *Applied Energy* 93:337–47. doi:10.1016/j.apenergy.2011.12.048

Appendix A

IDA-ICE models ACBs as integrated terminals consisting of an idealized supply air terminal with a damper and a water coil heat exchanger (EQUA Simulation Technology Group 2018). The total thermal capacity (\dot{Q}_t) includes the capacity of the ventilation air (\dot{Q}_a) and the capacity of the water coil (\dot{Q}_w):

$$\dot{Q}_t = \dot{Q}_a + \dot{Q}_w \quad (1)$$

The cooling capacity of the water coil is mainly associated with the difference between the supply and the return water temperatures (Filipsson et al. 2017):

$$\dot{Q}_w = K \cdot \Delta T^n \quad (2)$$

$$\Delta T = T_{room} - \frac{T_S + T_R}{2} \quad (3)$$

where T_S is the supply water temperature, T_R (°C) is the return water temperature, and T_{room} (°C) is the room air temperature. K and n are empirical factors associated with the primary air and water flow rates.

The ventilation cooling capacity is calculated from space's primary (T_p) and exhaust (T_e) air temperatures, air density (ρ_a) (kg/m³), specific cooling capacity of air ($C_{p,a}$) (J/kg-K), and primary airflow rate to the beam (\dot{V}_a) (m³/s):

$$\dot{Q}_a = \dot{V}_a \cdot \rho_a \cdot c_{p,a} \cdot (T_e - T_p) \quad (4)$$

Appendix B

The IDA-ICE borehole model performs transient heat transfer calculations to define the upward and downward fluid temperature in a BHE. The model considers the thermal capacitance of the fluid, the filling material, and the ground. However, the thermal capacitance of the pipe is neglected. The input parameters to the model are physical and thermal properties of the ground, filling material type and thermal properties, thermal properties and dimensions of the U-tube and the casing pipe, and the thermal properties of the fluid. The borehole thermal resistance needs to be provided by the user.

IDA-ICE calculates the energy balance of the upward fluid and the downward fluid based on the following set of equations (Eriksson and Skogqvist 2017):

$$\begin{aligned} \rho_{Liq} \cdot c_{p,Liq} \cdot V_{Liq} \frac{dT_{d,i,j}}{dt} = & m_i \cdot c_{p,Liq} \cdot (T_{d,i,j-1} - T_{d,i,j}) \\ & + K_{LiqGrout,i} \cdot (T_{GroutD,i,j} - T_{d,i,j}) \\ & + K_{LiqEarth,i} \cdot (T_{Real,i,j} - T_{d,i,j}) \end{aligned} \quad (5)$$

$$\begin{aligned} \rho_{Liq} \cdot c_{p,Liq} \cdot V_{Liq} \frac{dT_{u,i,j}}{dt} = & m_i \cdot c_{p,Liq} \cdot (T_{u,i,j+1} - T_{u,i,j}) \\ & + K_{LiqGrout,i} \cdot (T_{GroutU,i,j} - T_{u,i,j}) \\ & + K_{LiqEarth,i} \cdot (T_{Real,i,j} - T_{u,i,j}) \end{aligned} \quad (6)$$

where ρ_{Liq} is density of the fluid (kg/m³), $c_{p,Liq}$ is specific heat capacity of the fluid (J/kg-K), V_{Liq} is volume

of each pipe cell (m^3), $Td_{i,j}$ is temperature of the downgoing fluid in node j of borehole i ($^{\circ}C$), m_i is mass flow rate of the fluid in borehole i (kg/m^3), $K_{LiqGrout,i}$ is heat transfer coefficient between fluid and filling material in borehole i (W/K), $T_{GroutD,i,j}$ is grout temperature around downflow pipe at layer j of borehole i ($^{\circ}C$), $K_{LiqEarth,i}$ is heat transfer coefficient between fluid and ground in borehole i (W/K), $T_{Real,i,j}$ is ground temperature at borehole i in node j ($^{\circ}C$), $Tu_{i,j}$ is, and $T_{GroutU,i,j}$ is grout temperature around upflow pipe at layer j of borehole i ($^{\circ}C$).

Energy balance of the filling material is calculated according to the following set of equations (Eriksson and Skogqvist 2017):

$$\begin{aligned}
 Mc_{p,Grout1} \cdot \frac{dT_{GroutD,i,j}}{dt} &= K_{GroutGrout} \cdot (T_{Grout,i,j} - T_{GroutD,i,j}) \\
 &+ K_{LiqGrout,i} \cdot (Td_{i,j} - T_{GroutD,i,j}) \\
 &+ K_{RingEarth} \cdot (T_{Real,i,j} - T_{GroutU,i,j})
 \end{aligned} \quad (7)$$

$$\begin{aligned}
 Mc_{p,Grout1} \cdot \frac{dT_{GroutU,i,j}}{dt} &= K_{GroutGrout} \cdot (T_{Grout,i,j} - T_{GroutU,i,j}) \\
 &+ K_{LiqGrout,i} \cdot (Td_{i,j} - T_{GroutU,i,j}) \\
 &+ K_{RingEarth} \cdot (T_{Real,i,j} - T_{GroutU,i,j})
 \end{aligned} \quad (8)$$

$$\begin{aligned}
 Mc_{p,Grout2} \cdot \frac{dT_{Grout,i,j}}{dt} &= K_{GroutGrout} \cdot (T_{GroutD,i,j} + T_{GroutU,i,j} \\
 &- 2T_{Grout,i,j}) + K_{GroutEarth} \cdot (T_{Real,i,j} - T_{Grout,i,j})
 \end{aligned} \quad (9)$$

where $Mc_{p,Grout1}$ is absolute heat capacity of inner grout (J/K), $Mc_{p,Grout2}$ is absolute heat capacity of outer grout (J/K), $T_{Grout,i,j}$ is temperature of outer grout in node j of borehole i ($^{\circ}C$), $T_{GroutU,i,j}$ is grout temperature around upflow pipe at node j of borehole i ($^{\circ}C$), $T_{GroutD,i,j}$ is grout temperature around downflow pipe at layer j of borehole i ($^{\circ}C$), $K_{GroutEarth}$ is heat conduction coefficient between grout and ground (W/K), $K_{RingEarth,i}$ is heat conductivity coefficient between grout ring and ground (W/K), and $T_{Real,i,j}$ is ground temperature at borehole i in node j ($^{\circ}C$).