

THESIS FOR THE DEGREE OF LICENCIATE OF ENGINEERING

Geometry linking the art of building and the Universe

Geometric patterns on shells and grid shells

EMIL ADIELS

Department of Architecture and Civil Engineering
Division of Architectural Theory and Methods
Architecture and Engineering Research Group
CHALMERS UNIVERSITY OF TECHNOLOGY

Göteborg, Sweden 2021

Geometry linking the art of building and the Universe
Geometric patterns on shells and grid shells
EMIL ADIELS

© EMIL ADIELS, 2021

Thesis for the degree of Licentiate of Engineering
Series name: Lic /Architecture and Civil Engineering / Chalmers University of Technology
ACE 2021-0058
Department of Architecture and Civil Engineering
Division of Architectural Theory and Methods
Architecture and Engineering Research Group
Chalmers University of Technology
SE-412 96 Göteborg
Sweden
Telephone: +46 (0)31-772 1000

Cover:

Asymptotic grid shell as an exhibition space, built with students in the course Parametric Design - Digital Tools with bachelor students at the Architecture and Engineering program in 2019. The author was the part of the design team together with I. Naslund, J. Isaksson, H. Moubarak and C. J. K. Williams

Chalmers Reproservice
Göteborg, Sweden 2021

Geometry linking the art of building and the Universe
Geometric patterns on shells and grid shells
Thesis for the degree of Licenciate of Engineering
EMIL ADIELS
Department of Architecture and Civil Engineering
Chalmers University of Technology

ABSTRACT

Geometry links the art of building and the physics of space-time. Mathematical breakthroughs in geometry have led to new ways of designing our structures and our ability to visualise and describe the world, phenomena in nature and the universe. However, in contemporary architecture and structural engineering, a more profound understanding of geometry has been forgotten. This thesis aims to resurrect geometry in architecture and engineering in connection with the rapid development of new digital tools for design and production—particularly the connection between the structural action related to the design of the geometrical patterns on shells structures are treated. A brief historical overview of geometry is conducted, and with an emphasis on its applications in architecture in terms of structural design and economic production. Furthermore, the connection to a sustainable building culture from the standpoint of the Davos declaration 2018, calling for a high-quality *Baukultur* is investigated. The concept of *Baukultur* (building culture in English) defined in the Davos declaration is related to architectural quality but has a broader meaning as it concerns the final product and the associated processes and its effect in society. Moreover, the concept of craftsmanship and workshop culture is examined, and how it is already present in computer code development and contemporary innovative research cultures combining architectural design and technology. Taking departure from the 18th-century experimental scientist Joseph Plateau and the contemporary artist Andy Goldsworthy, the connection between scientific and artistic research is investigated. Four articles are included; all connected to various ways of architectural applications of geometry in the design process. The first article describes a way to interpret empirically derived brick patterns, specifically the bed joints, using differential geometry. Two methods to apply this in the design processes of new brick vaults are presented. The first is purely geometrical and can be applied on an arbitrary shape with the possibility to apply several patterns; the second is an iterative method of generating a funicular shape and its pattern simultaneously. The second and third paper describes the design and construction process of two different wooden structures built of straight planar laths. Both studies examine the possibilities of using geometry as a link between various parameters in a design process using digital tools to achieve complex forms using simple elements and production methods. The fourth paper examines an appropriate form for a shell, that can balance aesthetics, structural performance and build-ability, with a proposal for the use of surfaces with constant solid angle. In this paper, the surface was generated with a Delaunay triangulation. Thus, future studies would include incorporation of other types of patterns facilitating buildability.

Keywords: Geometry, Shell, Grid shell, Conceptual design, Structural design, Form finding, Architecture, Engineering, Differential Geometry, Masonry, Craftsmanship

SAMMANFATTNING

Geometri är länken mellan byggnadskonsten och vår moderna uppfattning av fysik. Matematiska genombrott inom geometri har lett till nya sätt att designa våra strukturer liksom vår förmåga att visualisera och beskriva världen och fenomen i naturen och universum. Bland dagens arkitekter och ingenjörer har den geometriska viktiga kopplingen mellan våra idéer och dess fysiska verkningssätt glömts bort eller förbisetts. Denna uppsats syftar till att återinföra geometri som ett verktyg inom arkitektur och teknik i kombination med digitala verktyg i en designprocess. Särskilt studeras geometriens möjlighet att koppla strukturella verkningssätt till utformningen av geometriska mönster för skalkonstruktioner.

Den första delen av avhandlingen ger en översikt och bakgrund till de bifogade artiklarna. En kort historisk översikt kring geometri med betoning på dess tillämpningar inom arkitektur när det gäller strukturell design och resurseffektiv produktion är utförd. En kort historisk översikt över geometri genomförs och med betoning på dess tillämpningar i arkitektur när det gäller strukturell design och ekonomisk produktion. Därtill undersöks kopplingen till en hållbar byggnadskultur utifrån Davos-deklarationens 2018 mål för en högkvalitativ *Baukultur*. Begreppet *Baukultur* (byggnadskultur på svenska) som definieras i Davos-deklarationen är relaterat till arkitektonisk kvalitet men har en bredare betydelse eftersom det inkluderar slutprodukten dess tillhörande processer och dess inverkan i samhället. Dessutom undersöks begreppet hantverk och hur det relaterar till nutida digitala hantverk inom programmering och kodutveckling. Samt samtida innovativa forskningskulturer som kombinerar arkitektonisk design och teknik. Med utgångspunkt från den experimentella forskning av 1800-tals vetenskapsmannen Joseph Plateau och nutida konstnären Andy Goldsworthy undersöks sambandet mellan metoder i traditionell och konstnärlig forskning. Den första artikeln beskriver ett sätt att tolka empiriskt härledda tegelmönster, mer specifikt liggfogarna, med hjälp av det teoretiska ramverket inom differentiell geometri. Två metoder beskrivs för att tillämpa detta i design av nya tegelvalv. Den första är rent geometrisk och kan appliceras på en godtycklig form med möjlighet att applicera flera mönster. Den andra är en iterativ metod för att generera både mönster och form samtidigt, där mönstret följer de tryckta huvudspänningsriktningarna. Den andra och tredje artikeln beskriver design- och konstruktionsprocessen för två olika träkonstruktioner byggda av raka plana remsor i plywood. Artiklarna undersöker möjligheten att använda geometri som en länk mellan olika parametrar i en designprocess och i kombination med digitala verktyg uppnå komplexa former med enkla byggelement och enkla produktionsmetoder. Det fjärde papperet utgår från frågan vad som är en bra form för ett skal, som kan balansera estetik, strukturell prestanda och byggbarhet? Vi föreslår användandet av ytor med konstant rymdvinkel. I artikeln genereras ett Delaunay-mönster på denna form, men framtida studier kan inkludera av andra typer av mönster som underlättar produktion och uppförande i byggskedet.

A few months ago Kia asked me to write about the connection between geometry and architecture. To Kia Bengtsson Ekström †

PREFACE

“Do you live here...?”, said the surprised technician from the Swedish energy agency. According to her instructions, this was the facilities boiler room with all technical installations, which was true. Still, to her astonishment, she stepped into a workshop of gears, motorcycle chains where two children were sleeping on the floor. She found herself in almost a medieval workshop where the border between family life and the workshop space was nonexistent. At that time, my brother and I aimed to become world champions like our hero Tony Rickardsson in a motorsport called *Speedway* where we toured together with our father around Sweden, caring little about much else. It is a motorsport of extreme simplicity. French aviator Antoine de Saint Exupéry describes perfection in his book *Wind Sand And Stars* as: “In anything at all, perfection is finally attained not when there is no longer anything to add, but when there is no longer anything to take away, when a body has been stripped down to its nakedness” (Saint-Exupéry 1939, p.66). Nothing can be more true for a speedway bike. It is basically an engine on wheels: one cylinder, fixed gear, no breaks and no back-wheel suspension. Since the bike is stripped of all leisure, the skills come to handle the bike and becoming one with the machine. That also includes service and repair between the races. During those years me and my brother learned about what it takes to be a craftsman, both on and off the track. However, my father was clear that he was not content with me becoming a craftsman like himself, “Son, if you intend to become a bricklayer like your father, I will strangle you in your sleep. It might sound harsh, but it is, in fact, an act of kindness”. It was not a threat but rather an expression of years of struggles and poor treatment as a bricklayer throughout the '90s recession in Sweden. During several years many of them, if they had any work at all, was forced to work on short contracts, sometimes spanning a week. It was not that my father did not like his work. We often walked around in the city where he told stories of the former master builder's skills, and with awe, pointed out specific details only a craftsman notice. With simple tools as a trowel and a plummet, they built masterpieces with their hands using bricks. That level of craftsmanship no living bricklayer could accomplish, he said. He often revisited the buildings he had worked on several years after to evaluate the long term effects. I think the reluctance was due to an industry that did not value his and his colleague's skills and knowledge, which is probably a shared feeling among other professions. I have always found that sad when skilled, committed and passionate people feel badly treated, or that their knowledge is valued less because they do not have an academic degree. That is why, no matter how much my father loved the work, he did not wish his son to experience the industry's dark side and instructed me to study at the university. The studies started at the dual program in architecture and engineering—an entirely new world of new references and a different culture. Most important was the study tours in Italy, the United Kingdom and Switzerland. In London, I saw the glass roof over the British Museum Court Roof for the first time, and I was amazed by the geometry and the public space is created. It somehow reminded me of the masonry vaults me and my dad talked about. Several years later, I would meet professor Chris Williams, who generated the geometry. Yet, before that, I did an internship between my bachelor and my master on Buro Happold, the structural engineering consultancy behind the British Museum Court Roof. I was fortunate to work with both geometry and programming developing schemes for grid shells. Sometimes we were consulted late

in the process. Thus, it was sometimes much tricky or impossible to please architects, contractors, manufacturers, and engineers regarding aesthetics, buildability, and structural performance with too many parameters fixed. I understood that there was a relationship between those three and that geometry was the key. Hence, I would need to know more theory and work with those parameters simultaneously earlier in the design process. Back at university, I tried to find courses in geometry, but it was easier said than done. I managed to enrol on a course in differential geometry; I somehow understood that this was what I would need, but it wasn't easy to find direct applications. It was not until I got in touch with professor Chris Williams that I understood how it could be related to architecture and physics. Furthermore, during my studies, I was lucky to be one of the organisers of the big conference *Smartgeometry*. A symposium where architects, engineers, programmers and researchers meet to investigate the connection between architecture and technology during a four-day hackathon. It was an exciting and open atmosphere where it was an iterative loop between ideas and experiments. Except for the love of that experimental environment, I became aware of the craft of organising workshops.

This thesis combines four parts— the interest for craftsmanship and architectural history, geometry, code development and workshops.

ACKNOWLEDGEMENTS

First of all, I would like to thank my examiner, Prof. Karl-Gunnar Olsson, for his support and mentorship both before and during my PhD studies. I am very grateful for all conversations, discussions, feedback and the exciting events at Chalmers that you have enabled and I have had the opportunity to be part of.

I would also like to thank my supervisors, Prof. Chris Williams and Dr Mats Ander. I cannot thank Chris enough for his wisdom, he generously shares, and for opening up an entirely new world of insights and references, especially in geometry and the connection to architecture physics. Also for advice and generous support during the experiments and workshops. I want to thank Mats for valuable discussions, ideas, endless enthusiasm and encouragement.

I want to thank several people for interesting discussions, comments, encouragement, feedback help or advice during different times including Peter Christensson, Morten Lund, Kia Bengtsson Ekström, Maja Kovacs, Jonas Carlsson, Stefano Delia, Prof. Angela Sasic Kalagasidis, Joosef Leppänen, Prof. Sigrid Adriaenssens, Prof. Philippe Block, Dr Matthias Rippmann, Prof. Klas Modin, Assoc. Prof. Jan Stevens, Ulla Antonsson and Stefan Lundin. I want to especially thank my PhD colleagues Erica Hörteborn, Alexander Sehlström and Jens Olsson, for all valuable conversations, discussions and support, both at work and off work.

I want to thank those who have been part of, helped or supported the many workshops at Chalmers including Isak Näslund, Emil Poulsen, Nicolo Bencini, Puria Safari, Cecilie Brandt-Olsen, Johanna Isaksson, Habiba Moubarak, Dr Robin Oval, Carl Hoff, Alison Martin, Tim Finlay, Dr Al Fisher, Robert Otani, Peter Lindblom, Tabita Nilsson, Sebastian Almfeldt, Anders Karlsson and Tord Hansson. It has been some of the best days in my life, thank you!

Many thanks to Tomas Gustavsson for the support and many exciting conversations regarding brick and masonry structures.

I would like to express much gratitude to Cramo Göteborg and especially Christian Dimitrossopoulus and Mikael Torstensson for supporting and sponsoring the workshops at Chalmers.

I want to thank ARQ research fund for supporting my studies in masonry which has been valuable in my research.

I would also like to thank Dr Shrikant Sharma for allowing me to do my internship at Buro Happold, on which I learned a lot, and it was an exciting time. That experience have been influential for my research.

Most of all I want to thank my fiancée Linnea Lundberg and my family for the endless support, especially when there has been a bump in the road in my work, they have helped me get back on track.

CONTENTS

Abstract	i
Sammanfattning	ii
Preface	v
Acknowledgements	vii
Contents	ix
I Introduction and overview	1
1 Introduction	3
1.1 Space tells matter how to move; matter tells space how to curve	3
1.2 Building a New York City every month	4
1.3 Aim and research questions	5
2 Context	7
2.1 Geometry and architecture	7
2.1.1 Birth of geometry	7
2.1.2 The geometry of the master builder	9
2.1.3 Differential geometry	16
2.1.4 Strength through geometry	20
2.1.5 Rational construction through geometry	28
2.2 A sustainable building culture	33
2.2.1 What is a sustainable building culture?	33
2.2.2 Davos declaration and Baukultur	36
2.2.3 The hand and brain relationship - Towards a digital craft	38
2.2.4 Machines, a friendly tool or an enemy?	41
2.2.5 Architecture as a workshop culture	43
3 Art and Science - Research and design	49
3.1 The blind scientist blowing bubbles	49
3.2 Research in art and design	52
3.3 Limitations and research methodology	61
3.3.1 Research question 1	62
3.3.2 Research question 2	64
4 Summary of papers and other important works	69
4.1 Paper A	69
4.2 Paper B	69
4.3 Paper C	70

4.4	Paper D	70
4.5	Publication I	71
4.6	Publication II	71
5	Discussion	73
5.1	Research questions and results	73
5.2	Sustainability - Digging where we stand	76
5.3	Conclusion	78
5.4	Future research	79
	Picture credits	81
	References	83
II	Appended Papers A–D	95

Paper A

E. Adiels, M. Ander, and C. J. K. Williams (2017). “Brick patterns on shells using geodesic coordinates”. *IASS Annual Symposium 2017 “Interfaces: Architecture . Engineering. Science”*. September, pp. 1–10

Paper B

E. Adiels, N. Bencini, C. Brandt-Olsen, A. Fisher, et al. (2018). “Design , fabrication and assembly of a geodesic gridshell in a student workshop”. *IASS Symposium 2018 ”Creativity in Structural Design”*, pp. 1–8

Paper C

E. Adiels, C. Brandt-Olsen, J. Isaksson, I. Näslund, K.-G. Olsson, et al. (2019). “The design , fabrication and assembly of an asymptotic timber gridshell”. *Proceedings of the IASS Annual Symposium 2019 - Structural Membranes 2019*. October. Barcelona, pp. 1–8

Paper D

E. Adiels, M. Ander, and C. J. K. Williams (2019). “Surfaces defined by the points at which a closed curve subtends a constant solid angle”. *Proceedings of the Diderot Mathematical Forum*

Part I
Introduction and overview

1 Introduction

1.1 Space tells matter how to move; matter tells space how to curve

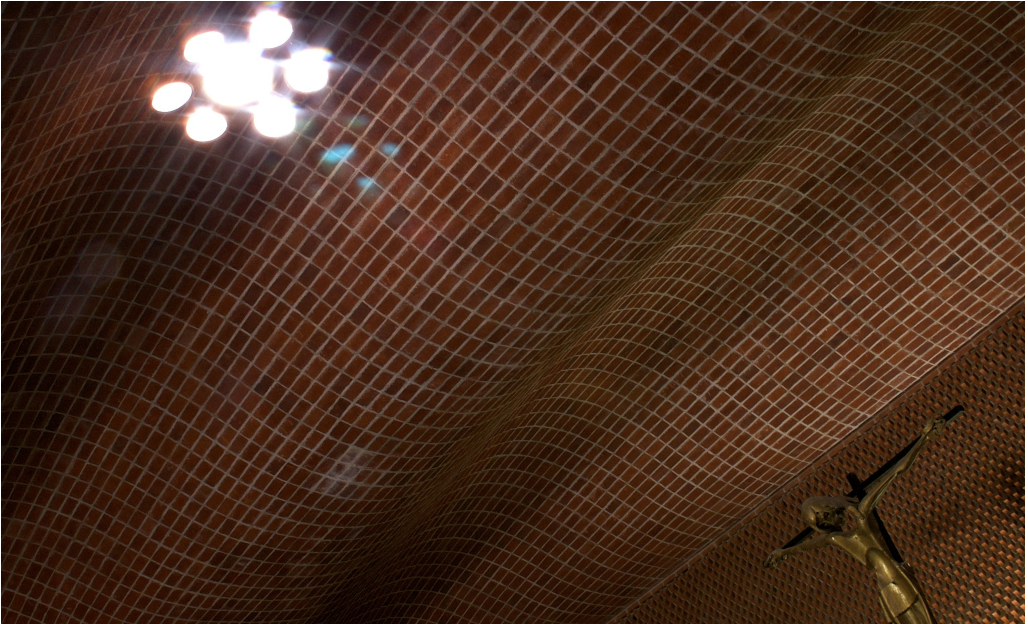


Figure 1.1: *Church of Christ the Worker in Atlántida, Montevideo , Uruguay, by Eladio Dieste (1958–60).*

Geometry is what links the art of building and the physics of space-time. Imagine zooming in really close on any part of our body, even though globally much curved, the small region will be nearly flat, like a brick in the brick vault as in Figure 1.1. Similarly, we live on a sphere called earth, but we see our surroundings as flat. Therefore, even if we live on a surface of higher dimensions than the three, we can see, trace or move within, we still would experience the ground as flat. That is at least in principle how Riemann imagined it, as Dirac (1975) describes:

In the same way, one can have a curved four-dimensional space immersed in a flat space of a larger number of dimensions. Such a curved space is called a Riemann space. A small region of it is approximately flat. Einstein assumed that physical space is of this nature and thereby laid the foundation for his gravitation theory. (p.9)

The relatively new mathematics of Riemann enabled Einstein (1920) a geometrical representation for something as abstract as gravity. Gravity, Einstein claimed, is not due

to forces exerted between bodies but due to curvature in the fabric of space-time caused by the matter of those bodies. Physicist John Archibald Wheeler describes it as, “matter tells space how to curve, and space tells matter how to move” (Grøn and Næss 2011, p.211), as if the geometry and the physics are in dialogue, bounded to one another.

1.2 Building a New York City every month

Similarly, as Einstein thought that geometry, or the curvature of it, is the key to understand the Universe, the structural engineer Allan McRobie (2017) see structures through their embodied energy and equilibrium surfaces:

The structural column that holds the building above your head may be straight, but in the wonderfully imaginative mind of the structural engineer who designed it there live the energy and equilibrium surfaces whose abstract mathematical forms are so sensuously seductive, so beautiful that if they were made solid for you to see them you would want to stroke and caress them. (p.21)

As in Einstein’s theory of relativity, the structural behaviour and the form are connected through the geometry. Thus, it exists a connection between structural efficiency and the curved shape. It is relevant since one of the major threats of life on earth is connected to the effects of climate change. According to B. Gates and M. Gates (2019) the world will need build an equivalent to New York City every month for 40 years based on the estimated global population growth until 2060. As B. Gates and M. Gates continue, “That’s a lot of cement and steel. We need to find a way to make it all without worsening climate change”. However, structural performance only matters in architecture if we can realize it. Structures need to made of materials turned into building elements that somehow are fit together by a person or a machine, the more curved the shape the more difficult to construct. It adds a geometrical constraint to not only the form but also the pattern which describe its building blocks. Russian mathematician Chebyshev used similar geometry as Riemann to understand the complex cutting patterns of textiles, which, according to Chebyshev (1887/1946), can be applied to any body:

I touched on another question about fabrics, the solution of which with the help of mathematics may be of certain interest, namely, the cutting of fabrics in the manufacture of clothing or, in general, the shells of any kinds of bodies.¹ (p.38)

This quote also highlights the aspect of manufacturing that adds to the challenge of building sustainable. Such that elements can be made in a simple process in a suitable format and an accessible material, as described by Alexander et al (1977).

The central problem of materials, then, is to find a collection of materials which are small in scale, easy to cut on site, easy to work on site without the

¹Translated from Russian to English with the help of Konstantin Mina

aid of huge and expensive machinery, easy to vary and adapt, heavy enough to be solid, longlasting or easy to maintain, and yet easy to build, not needing specialized labor, not expensive in labor, and universally obtainable and cheap. (p.956)

Master builders such as Rafael Guastavino Jr. (Ochsendorf 2010) and Eladio Dieste (Anderson 2003) saw the possibilities and freedom of using a simple building element like the bricks in the architectural design process. They used small tiles, and brick, to create structurally efficient and beautiful elaborate vaults. Could Riemann and Einstein's thought model be reverted to instead imagine the flat region as a simple element like a brick and the universal fabric is a weave of bricks? Is it possible to learn from craftsmen like Guastavino in a modern context, using contemporary geometrical knowledge and digital tools?

1.3 Aim and research questions

This work aims to reinstate geometry as a tool for the architect, the engineer, and the builder, in order to develop tools and strategies enabling design and construction of curved shapes by use of simple building elements. It has led to the following research questions:

1. How can the current building culture be challenged by a reconsideration of historical and recent knowledge in geometry?
2. How can the current building culture be challenged by a development of a digital craftsmanship for sustainable architectural design and production?

2 Context

2.1 Geometry and architecture

This section covers the origins of geometry emerging from two directions; the craft and astronomy. Furthermore, the use of geometry in architecture and the importance to the master builder. It continues to describe the development of and the theory of differential geometry, which is applied in the analysis of membrane shell. The section ends with how designers have used geometry and simple building elements to economise construction and manufacturing.

2.1.1 Birth of geometry

Heilbron (2020) defines geometry as “the branch of mathematics concerned with the shape of individual objects, spatial relationships among various objects, and the properties of surrounding space”. It is one of the oldest branches of mathematics and likely came out of the crafts and works by the hand. For weavers and bricklayers, the pattern is an essential part of the making due to its structural influence, Figure 2.1b. The craft of basket weaving goes back to at least 7000 B.C. (Geib and Jolie 2008). In old pottery, the form and the pattern also have aspects of pure beauty (Struik 1987), Figure 2.1a. Thus, mathematician Struik (1987) suggests the connection between the birth of geometry and weaving through the etymology “The word ‘straight’ is related to ‘stretch’, indicating operations with a rope; the word ‘line’ to ‘linen’, showing the connection between the craft of weaving and the beginnings of geometry. ”(Struik 1987, p.11)

In Mesopotamia and Egypt, geometry was a tool for solving practical problems. It is believed the geometry in Egypt was needed for surveying tasks such as approximating the size of lands for taxation; a knowledge believed transferred to the Greek scholars. It can be found in writing by Greek historian Herodotus (c.484 – c.425 B.C):

For this reason Egypt was cut up; they said that this king distributed the land to all the Egyptians, giving an equal square portion to each man, and from this he made his revenue, having appointed them to pay a certain rent every year: and if the river should take away anything from any man’s portion, he would come to the king and declare that which had happened, and the king used to send men to examine and to find out by measurement how much less the piece of land had become, in order that for the future the man might pay less, in proportion to the rent appointed: and I think that thus the art of geometry was found out and afterwards came into Hellas also. (Herodotus 440 B.C, para. 109)

However, the best source for the knowledge of mathematics and geometry in ancient Egypt is the Moscow Mathematical Papyrus and the Rhind Mathematical Papyrus dating from around 1800 and 1650 B.C, the Rosetta stones of geometry. They contain different problems of which some are geometrical. Likewise, many of the geometrical problems are of the kind of calculate the area and volume for different objects such as:

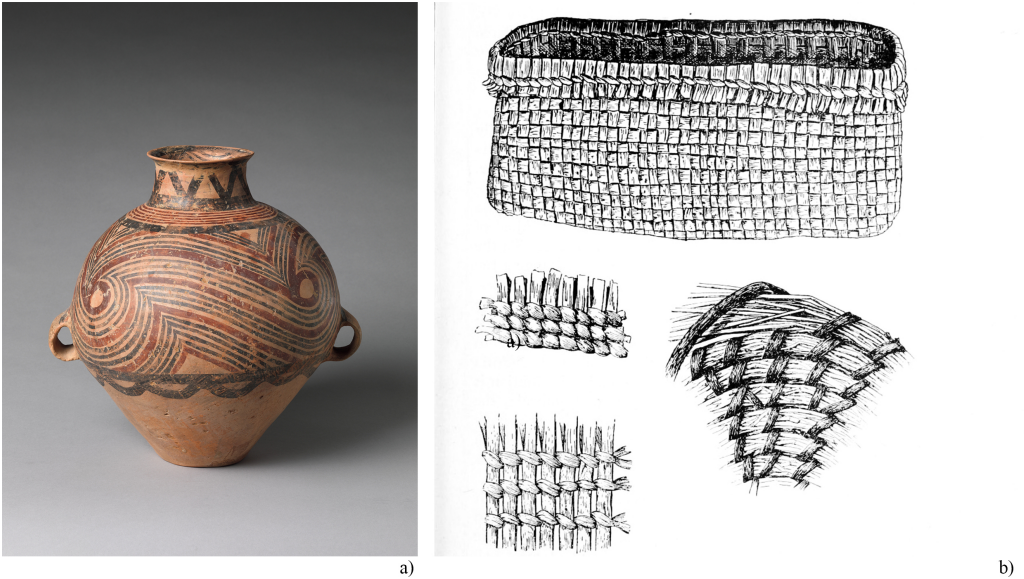


Figure 2.1: Both decorative and constructive patterns were likely employed in crafts before the development of the mathematical branch of geometry. In a) the Chinese Earthenware with decorated with complex patterns, ca. 2650–2350 B.C. urn. In b) showing weaving techniques and patterns used in Native American basketry (Wissler 1917)

Problem 50

Example Of [sic] a round field Of [sic] diameter 9 khet. What is its area? Take away $\frac{1}{9}$ of the diameter, namely 1; the remainder is 8. Multiply 8 times 8; it makes 64. Therefore it contains 64 setat of land. (Chace and Mannin 1927,p.92)

As described by Herodotus, it is believed that Greek scholars learned geometry in Egypt. Greek mathematicians who later excelled their former teachers. Neither in Mesopotamia or Egypt was there an interest in the science of geometry or proving the geometrical relations. It was the Greek scholars who found an interest and joy in asking the question *why*. The most influential book from Greece, which has survived, is *Elementa*. It consists of thirteen volumes, by Euclid (ca. 300 B.C.) who systematically organised the mathematical developments in Greece by that time. Another important is the eight-volume book *Conics* by Apollonius of Perga (262 B.C. – 190 B.C.) on the geometry of conic sections, i.e. the circle, the ellipse, the parabola and the hyperbola.

The first type on non-euclidean geometry was the spherical geometry, concerning geometric objects on the surface of a sphere. The reason for that was also much practical. Ancients called this geometry *Sphaerica*, and it was the study of the heavens and the heavenly bodies. The etymological meaning of geometry is the measurement of the earth. Spherical geometry made it possible to measure the phenomenon of time, the creation of the calendar. Already the geometers in Egypt divided the day into 24 hours (Rosenfeld

1988). It was to estimate the times to execute different operations linked to agriculture, when to plant and when to harvest. As Scherrer explains:

Our forbearers followed their sky gods' movements attentively. By marking their appearance & disappearance with great care, they combined religious worship with practical knowledge. The cycle of planting and harvesting crops was regulated by celestial events; important days of celebration and festivity were marked in a celestial calendar. After generations, they learned to predict particular celestial phenomena, such as eclipses, well in advance. (Scherrer 2015, p.3)

There are several early books on the subject of Sphaerica by for instance Theodosius (ca. 100 B.C.) and Menelaus (ca. 100 A.D.) (Rosenfeld 1988; Scriba and Schreiber 2015). The primary and essential difference is to imagine a geometry bounded on something curved rather than in the flat plane as in Euclidean geometry. Menelaus is the first known to define a spherical triangle, bounded by arcs of great circles, and its angles. They are described similarly as the plane triangle by Euclid. However, the most known work is *Almagest* by astronomer Ptolemy (ca. 100-170 A.D.) written about 150 A.D which gives an overview of the ancient astronomy in Babylonian and Greek cultures (Rosenfeld 1988).

Curved geometries such as arches and domes are also very efficient to carry loads, known to ancient builders and architects thousands of years before structural theory as defined today. However, it took many centuries before the non-euclidean geometry would play any significant role in the design, production or analysis of structures, as will be described in the next section.

2.1.2 The geometry of the master builder

Marvel ye not that I said that all sciences live only by the science of Geometry, for there is no artificial or handicraft that is wrought by man's hand but is wrought by Geometry, and a notable cause, for if a man works with his hands he worketh with some manner of tool, and there is no instrument of material things in this world, but it comes of some kind of earth, and to earth it will turn again. And there is no instrument, that is to say a tool to work with, but it hath some proportion more or less, and proportion is measure, and the tool or instrument is earth, and Geometry is said to be the measure of the earth. Wherefore I may say that men live all by Geometry ... Ye shall understand that among all the crafts of the world of man's craft Masonry hath the most notability, and most part of this science of Geometry as it is noted and said in history, and in the Bible, and in the Master of Stories (Yarker 1909, p.545)

The above quote is from the freemasons' ancient charges, believed to be from the 15th century. As this text describes, as well as shown in the previous section, geometry was a valuable tool for many things, including architecture and the art of building. Today, it is hard to fathom the difficulties these master builders had in measuring and setting out such a complex structure like a Gothic cathedral, or manufacture its stone blocks. Thus, the mason lived and embodied geometry to such extent that the unknown author

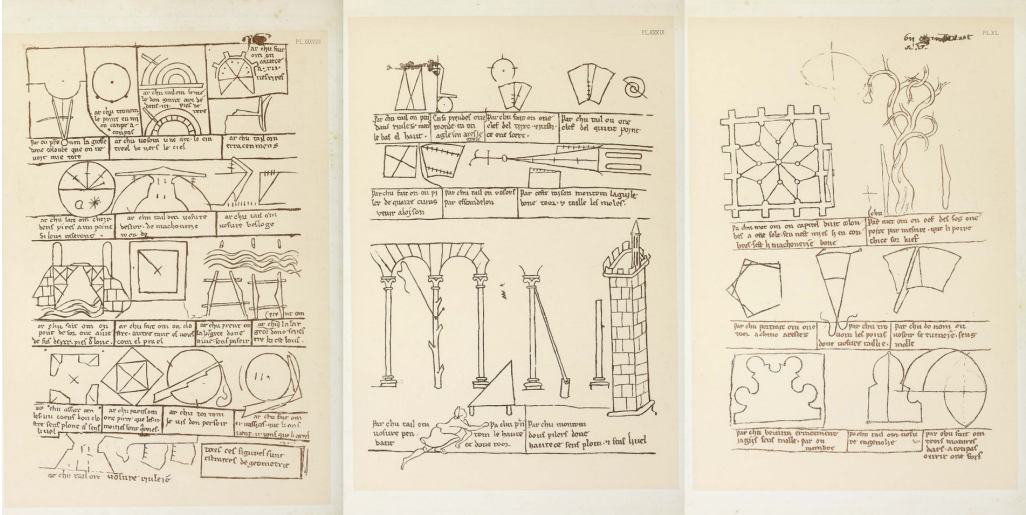


Figure 2.2: Sketchbook of Villard De Honnecourt from the 15th century (Villard et al. 1859)

states that masonry in principal is geometry. Like the Egyptians, the medieval master builder was likely more interested in practical geometry than theoretical geometry. In *The Geometrical Knowledge Of Mediaeval Master Masons* Shelby (1972) describes the profession. Those who aspired to become a master mason probably did not have time become an academic, possibly they did not even know how to read. As is well known, the early medieval master-builders did not have full access to Euclid’s geometry, only various fragments that are known to have gathered in the *Codex Arcerianus* from the 6th or 7th-century. Their time was likely invested in the more practical school at a construction site, and it was probably through their work or their master they learned geometry:

Since the geometry of the masons was an essential part of that technical knowledge, medieval master masons would normally have acquired their geometrical knowledge in the same way that they acquired the rest of their knowledge and skill in building - by mastering the traditions of the craft. (Shelby 1972, p.398)

The best source for the early medieval masons knowledge and application in geometry is found in the sketchbook of Villard De Honnecourt from the 15th century. Heyman (1995) refer to him as master builder, but similar to Roman architect Vitruvius (1914), one of the minor known while active. Villard’s book is a practical one as can be seen in Figure 2.2. It gives guidance for geometrical constructions such as: "How to trace the plan of a five-cornered tower", "Thus can be drawn three kinds of arches with one opening of the compasses", "How to find the point in the centre of a circular area", "How to cut the mold of a great arch in a space of three feet". More advanced treatises the geometry on stone cutting, usually referred to as stereotomy, can be found in for instance *Le Premier tome de l’Architecture*, Figure 2.3a, by Philibert Delorme (1567), the architect

behind the dome at Château d'Anet. Stereotomy is also used in the treatises of complex geometries in carpentry (Delataille 1887), Figure 2.4. At the 2016 Venice Biennale, the Armadillo Vault showed how stereotomy could be design, manufactured and applied in a contemporary context (Block, Van Mele, et al. 2017), Figure 2.5.

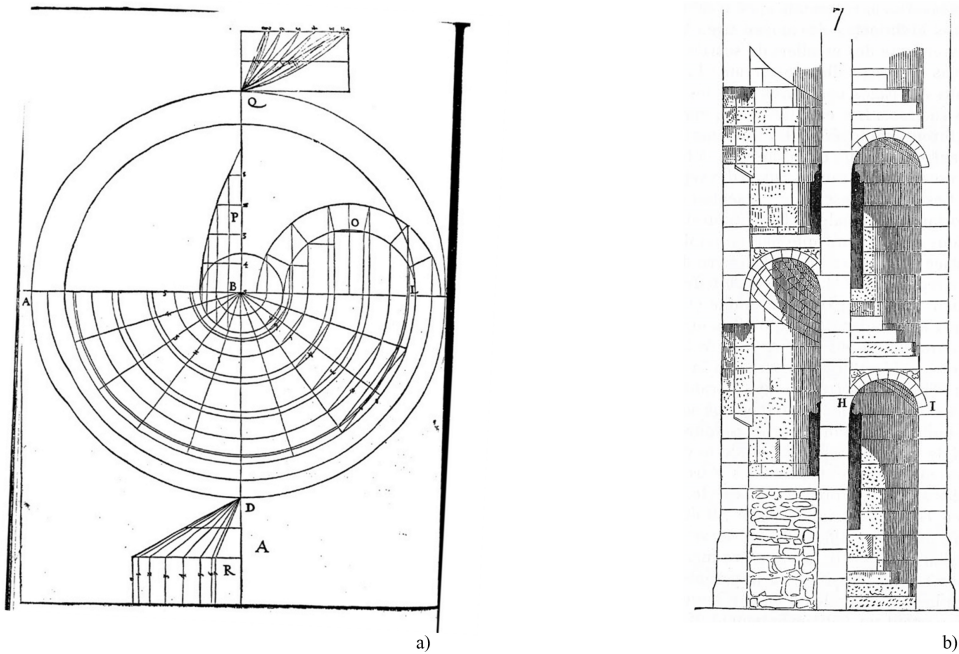


Figure 2.3: To the left a) diagram by Philibert Delorme of a helical barrel vault (or vis de Saint-Gilles) (Delorme 1567). Right b), Viollet-le-Duc on how such a stair could look like which was typically used in medieval structures in the 11th and 12th-century (Viollet-le-Duc 1875)

In Villard's book there exist elevations and plans, but they are not very accurate. Brunelleschi redeveloped the mathematics behind the perspective drawings to make more accurate representations (Addis 2007). Geometry was also essential in the design in terms of making the structure stable using rules of proportions. Yet, not much guidance of that character can be found in the book of Villard. Even though no such theory existed, the sketches of arches by Leonardo Da Vinci (Addis 2007; Benvenuto 1991) and the standing Gothic Cathedrals, indicates that master builders had an intuitive understanding of stability and forces. Later books such as *L'Architecture des voûtes, ou l'Art des traits et coupe des voûtes* by François Derand (1643) contains geometrical rules for sizing of abutments based on the form of the arch. The reason behind the sizing of buttresses is that the stresses in masonry structures like the Gothic cathedrals are relatively small in magnitude (Heyman 1995), and the problem is more related to stability. Gothic builders were much clever in that sense to add weight on top of the buttresses as a pre-stressing (Addis 2007), which can also be seen in the fan vaults in Figure 2.15. Dimensional rules

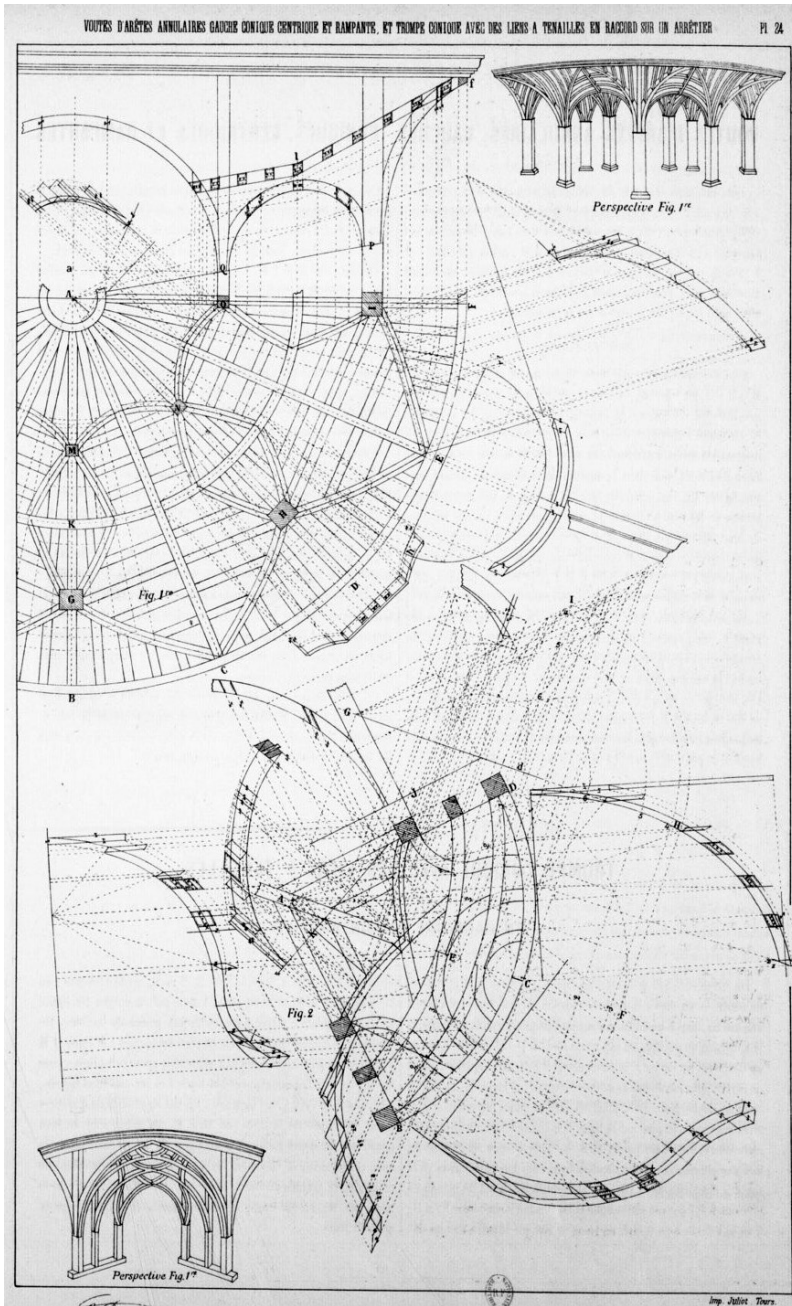


Figure 2.4: *Stereotomy and applied to complex geometries in carpentry (Delataille 1887)*



Figure 2.5: *Armadillo Vault at the 2016 Venice Biennale. Team: Block Research Group, Ochsendorf DeJong & Block (ODB Engineering) and Escobedo Group*

of domes can be found in *Il Tempio Vaticano e sua origine* by Carlo Fontana (1694) (Benvenuto 1991; Manzanares 2003). The last living master builders such as the Spanish originating Antoni Gaudí and Rafeael Guastavino Jr. used *graphic statics* (Collins 1960; Ochsendorf 2010). Graphic statics is a method to draw force diagrams connected to what one can call form diagram of one's structure. Graphic statics originates from the work by Carl Culmann (1866), James Clerk Maxwell (1864) and Luigi Cremona (1872) in the second half of the 19th century. Culmann was inspired by projective geometry, what Culmann called '*newer geometry*', of Jean-Victor Poncelet's¹ *Traité des propriétés projectives des figures* (1822) (Kurrer 2008). Graphic statics was presented by Culmann as an attempt to *solve the problems accessible to a geometrical treatment from the field of engineering with the help of the newer geometry* (Culmann 1866). The use of graphic statics declined in usage during the last half of the 20th century. There are several reasons, according to professor Block (personal communication, September 2018). One is that drafting such diagrams takes time and it requires skills in drafting, as seen in Figure 2.7. With the development of Elasticity theory by Navier, it was more convenient and

¹Poncelet was a pupil of Gaspard Monge. Serving in the Napoleon war, Poncelet became imprisoned. During his imprisonment Poncelet should have studied shadows, or projections, and their geometrical properties.

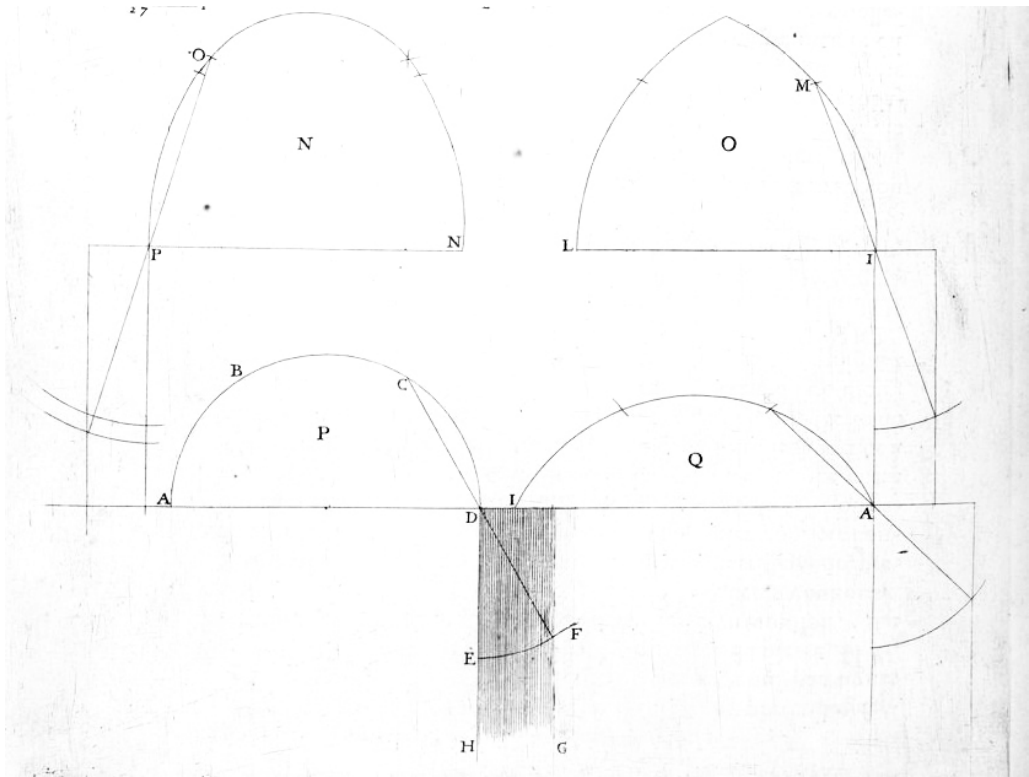


Figure 2.6: *Derand's geometrical rules for the relation between the form of the arch and the width of the abutments (Derand 1643)*

time-efficient for engineers to describe one safe solution by plugging in numbers in a formula. Thus, it comes to the cost of not seeing or describing the wide variety of possible stress states and load paths that inform the designer how to further develop the scheme. However, new digital tools assisting the time-consuming activity of drawing the diagrams graphic statics has got a new revival in the 21st century through the work of for instance Allen and Zalewski (2009) Block and Ochsendorf (2007) C. J. Williams and McRobie (2016).

To perform modern analysis of arches, domes and grid shells, it is convenient with a rigorous theoretical framework for describing and working with the geometry of curves and surfaces. This branch of mathematics is usually called *differential geometry* which will be covered in the following section.

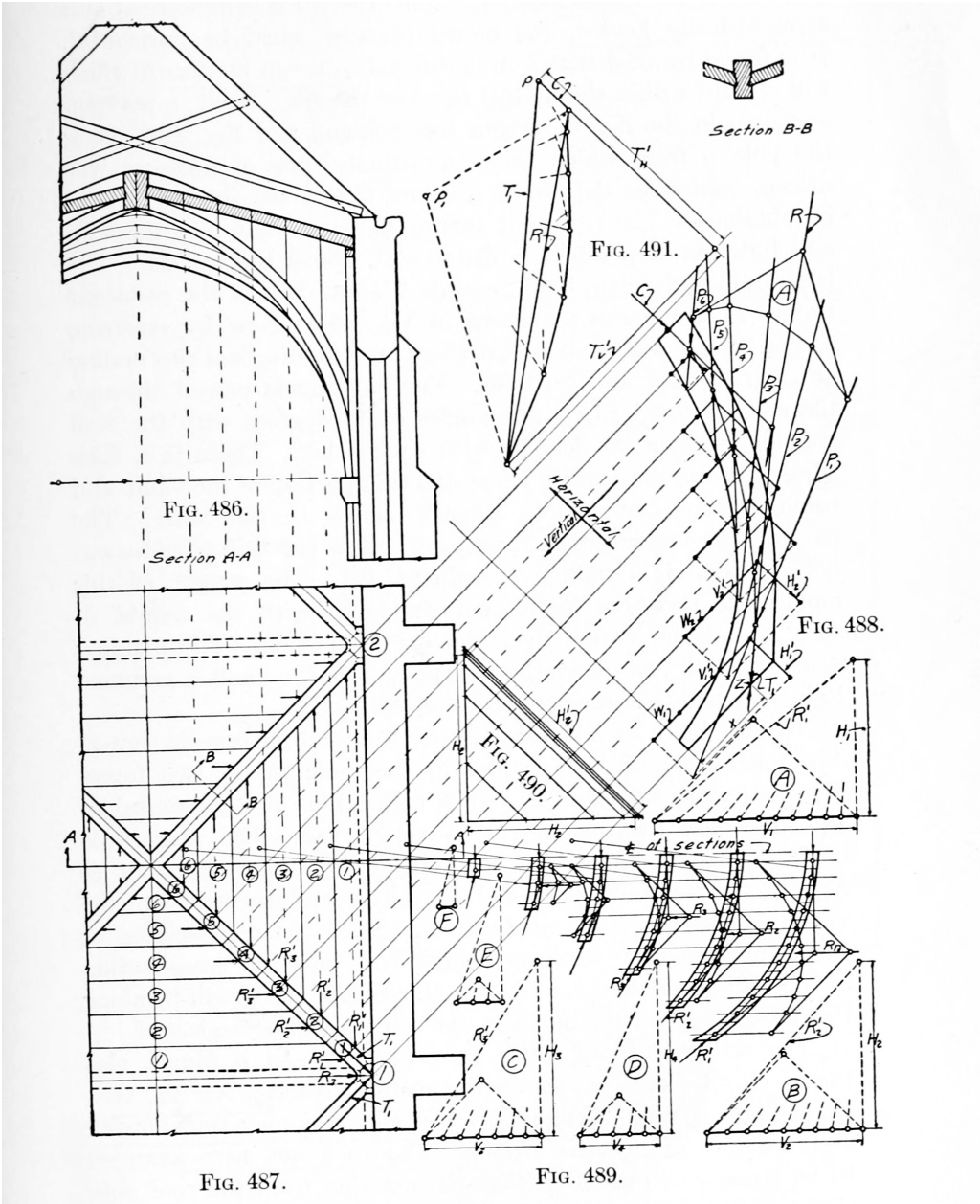


Figure 2.7: Analysis of a Gothic rib-vault using graphic statics in (Wolfe 1921)

2.1.3 Differential geometry

Nowadays, spherical geometry, or the geometry of domes if talking architecture, would be considered part of differential geometry, which is the branch of geometry that studies the properties curves and surfaces in space. Differential geometry can also describe geometries of higher dimension. For instance, in Einstein's general theory of relativity, the planets move along space-time geodesics.

Differential geometry originates from the development of analytical geometry and the differential and integral calculus. Analytical geometry was developed in 17th century by French mathematicians Fermat and Descartes. The emergence of analytical geometry resulted from a new interest in curves and the mathematical advancement in theory of equations in the 16th century by Viète (Struik 1987). This interest in curves was partly based on the texts written by the ancient Greek scholars such as Apollonius and Archimedes and the applications in physics in the field of astronomy, mechanics and optics. The importance of analytical, or sometimes called Cartesian geometry, is that it "establishes a correspondence between geometric curves and algebraic equations" (Bix and D'Souza 2020, Introduction section). Isaac Barrow's *Geometrical Lectures* is seen as a big influence for Leibniz and Newton, student of Barrow, in the formulation of the differential and integral calculus, and the fundamental theorem bringing them together. Differential calculus is needed when attaining the properties of the geometrical objects such as its curvature while integral calculus is needed when, for instance, calculating the arc length of a curve.

Struik (1988) states that Gaspard Monge and Carl Friedrich Gauss are the founders of the differential geometry of curves and surfaces. Other important contributors to the early development of the theory of differential geometry are Leonard Euler, John Bernoulli, Joseph-Louis Lagrange. Bernoulli showed that curves of shortest distance, geodesics, must only curve in the osculating plane. Euler described the principal curvature lines (Struik 1988) and Lagrange found the partial differential equations of minimal surfaces (Hyde et al. 1997). One of the big contributions by Gauss was to constitute a framework in which one can work with a globally smooth curved surface (non-euclidean geometry), which zoomed in on small area can be locally treated using euclidean geometry since it is nearly flat (Einstein 1920).

One of the most important aspects to consider in geometry is how to measure distances. Consider the Cartesian coordinate system, originating from Descartes, and its orthogonal grid in the plane with coordinate axes in x and y . The square distance ds^2 is described using Pythagoras theorem:

$$ds^2 = dx^2 + dy^2 \tag{2.1}$$

If the coordinates are not orthogonal the cosine rule needs to be used one would need to use the cosine rule which and (2.1) can be rewritten (cf. Figure 2.8),

$$ds^2 = dx^2 + 2dxdy \cos \alpha + dy^2 \tag{2.2}$$

Imagine a similar net of parallelograms as above but very small in size and applied on a smooth two dimensional surface, which can be curved and placed in three dimensional

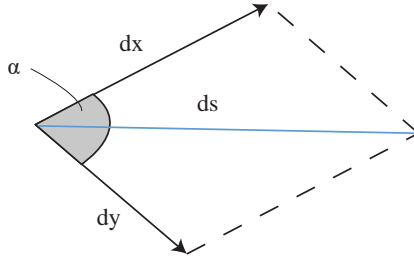


Figure 2.8: The length of the diagonal of a parallelogram of d , in which α is the angle between dx and dy

space, such as the earth. On a two dimensional surface, there exist two sets of coordinate curves in two directions. Struik (1988) uses u, v to describe these surface parameters, while Green and Zerna (1968) use θ^1, θ^2 . Using the latter convention, (2.2) becomes:

$$ds^2 = a_{11} (d\theta^1)^2 + 2a_{21} (d\theta^1) (d\theta^2) + a_{22} (d\theta^2)^2 \quad (2.3)$$

which gives the square of the distance between the points (θ^1, θ^2) and $(\theta^1 + d\theta^1, \theta^2 + d\theta^2)$ on the surface. Equation (2.3) is usually referred as the *first fundamental form* and $a_{\alpha\beta}$ are the components of the metric tensor²:

$$a_{\alpha\beta} = a_{\beta\alpha} = \mathbf{a}_\alpha \cdot \mathbf{a}_\beta = \begin{bmatrix} a_{11} & a_{12} \\ a_{21} & a_{22} \end{bmatrix} \quad (2.4)$$

$$a = a_{11}a_{22} - a_{12}a_{21} \quad (2.5)$$

The covariant base vectors \mathbf{a}_α are the vectors tangent to the coordinate curves, the curves on the surface where either θ^1 or θ^2 is constant. They are not necessarily orthogonal to each other but always orthogonal to the normal \mathbf{a}_3 . Compared to Cartesian coordinates, the surface base vectors change while moving on the surfaces. The covariant base vectors are defined as:

$$\mathbf{a}_\alpha = \frac{\partial \mathbf{r}}{\partial \theta^\alpha} = \frac{\partial x}{\partial \theta^\alpha} \mathbf{e}_1 + \frac{\partial y}{\partial \theta^\alpha} \mathbf{e}_2 + \frac{\partial z}{\partial \theta^\alpha} \mathbf{e}_3 = \mathbf{r}_{,\alpha}, \text{ for } \alpha = 1, 2 \quad (2.6)$$

Where the vector \mathbf{r} is the vector that describes the position in space.

$$\mathbf{r}(\theta^1, \theta^2) = x_1(\theta^1, \theta^2) \mathbf{e}_1 + x_2(\theta^1, \theta^2) \mathbf{e}_2 + x_3(\theta^1, \theta^2) \mathbf{e}_3 \quad (2.7)$$

²Struik (1988) uses E, F, G instead of a_{11}, a_{12}, a_{22}

The square distance ds^2 can now be written in the following way, using Einstein summation convention (A. Green and Zerna 1968).

$$ds^2 = d\mathbf{r} \cdot d\mathbf{r} = \mathbf{a}_\alpha \cdot \mathbf{a}_\beta d\theta^\alpha d\theta^\beta = a_{\alpha\beta} d\theta^\alpha d\theta^\beta = \sum_{\alpha=1}^2 \sum_{\beta=1}^2 a_{\alpha\beta} d\theta^\alpha d\theta^\beta \quad (2.8)$$

So far this section has covered how to measure distances and angles, but how much the surface curve? Gauss (1825/1827/1902) defines the curvature as the image of the Gauss map, basically taking a small region on the surface and mapping it onto a unit sphere using the normal vectors. The Gaussian curvature, K , is the ratio between the two areas; similar can be done on curves using the unit circle. According to himself, Gauss (1825/1827/1902) found the remarkable connection to the products of the the two principal curvatures, κ_1 and κ_2 , described earlier by Euler (Euler 1767; Struik 1988).

$$K = \kappa_1 \kappa_2 \quad (2.9)$$

It is also possible to express the Gaussian curvature on the following form

$$K = \frac{b_{11}b_{22} - (b_{12})^2}{a} \quad (2.10)$$

where $b_{\alpha\beta}$ are the components of the *second fundamental form*³, also forming a surface tensor. It is a measure of how much the coordinate curves bends in relation to the normal vector \mathbf{a}_3 :

$$-d\mathbf{r} \cdot d\mathbf{a}_3 = b_{11} (d\theta^1)^2 + 2b_{12}d\theta^1 d\theta^2 + b_{22} (d\theta^2)^2 \quad (2.11)$$

$$b_{\alpha\beta} = b_{\beta\alpha} = \mathbf{a}_3 \cdot \mathbf{a}_{\alpha,\beta} = \begin{bmatrix} b_{11} & b_{12} \\ b_{21} & b_{22} \end{bmatrix} \quad (2.12)$$

However, most remarkable Gauss's Theorema Egregium (Latin for "Remarkable Theorem") proved that the Gaussian curvature is intrinsic property. Thus, the Gaussian curvature can be expressed only using the components and derivatives of the metric tensor. It means that an ant, living on what it believes to be flatland, can come to the realisation that it lives on a curved surface by measuring distances and angles and calculating its derivatives. That is when writing the Gaussian curvature using the covariant Riemann-Christoffel curvature tensor as in (1.13.44) in Green and Zerna (1968)

$$K = \frac{1}{4} \epsilon^{\lambda\alpha} \epsilon^{\beta\gamma} R_{\lambda\alpha\beta\gamma} \quad (2.13)$$

where the components of the psuedo-tensor have the following relationship

$$\epsilon^{11} = \epsilon^{22} = 0, \quad \epsilon^{12} = -\epsilon^{21} = \frac{1}{\sqrt{a}} \quad (2.14)$$

³Struik (1988) uses e,f,g instead of b_{11}, b_{12}, b_{22} ,

This is due to that the Riemann-Christoffel curvature tensor can be expressed in Christoffel symbols as in (11.6) in Dirac (1975)

$$R_{prsi} = \frac{1}{2} (g_{pi,rs} - g_{ri,ps} - g_{ps,ri} + g_{rs,pi}) + \Gamma_{mpi} \Gamma_{rs}^m + \Gamma_{mps} \Gamma_{ri}^m \quad (2.15)$$

where the Christoffel symbols of the first and second kind are defined in Green and Zerna (1968) as

$$\Gamma_{ijr} = \Gamma_{jir} = \mathbf{g}_r \cdot \mathbf{g}_{i,j} \quad (2.16)$$

$$\Gamma_{ij}^r = \Gamma_{ji}^r = \mathbf{g}^r \cdot \mathbf{g}_{i,j} \quad (2.17)$$

In (2.15) the letter g is used instead of a when describing the metric tensor or and base vectors of higher order as in Dirac (1975) and Green and Zerna (1968). The indices are changed from greek to latin letters, as in Green and Zerna (1968) to differentiate between the two dimensional and the higher order surfaces and (2.8) becomes

$$ds^2 = \mathbf{g}_i \cdot \mathbf{g}_j d\theta^i d\theta^j = g_{ij} d\theta^i d\theta^j = \sum_{i=0}^3 \sum_{j=0}^3 g_{ij} d\theta^i d\theta^j \quad (2.18)$$

For a four dimensional surface the Riemann-Christoffel tensor contains 256 components, but due to its symmetry only 20 components are unique. The geometrical meaning of the Riemann-Christoffel is that it describes describes the magnitude of the basis vectors' rotation if one parallel transport a vector along a closed loop on a surface. In flatland the rotation would be zero comparing the start and end vector. Thus, the ant who performed this experiment would return to the starting point but with the a vector in a different angle, and could conclude that it lives on a curved surface. The Christoffel symbols of the first and second kind and can be understood as a measure of the rate of change of the basis vectors (Grøn and Næss 2011). When using curvilinear coordinates, in comparison to Cartesian coordinates, the base vectors change as one moves along the surface. Therefore, in Cartesian coordinates, the Christoffel symbols vanish. On a two dimensional surface the Riemann-Christoffel. For a two-dimensional surface there are only components four components of the Riemann-Christoffel that are not zero and they have the following relation

$$R_{1212} = -R_{2112} = -R_{1221} = R_{2121} \quad (2.19)$$

and (2.13) becomes

$$K = \frac{R_{1212}}{a} \quad (2.20)$$

For spherical coordinates where the coordinate curves cross at right angles one can simplify (2.20) as in (3-7) in Struik (1988):

$$K = \frac{1}{\sqrt{a_{11}a_{22}}} \left[\frac{\partial}{\partial \theta^1} \left(\frac{1}{\sqrt{a_{11}}} \frac{\partial \sqrt{a_{22}}}{\partial \theta^1} \right) + \frac{\partial}{\partial \theta^2} \left(\frac{1}{\sqrt{a_{22}}} \frac{\partial \sqrt{a_{11}}}{\partial \theta^2} \right) \right] \quad (2.21)$$

From the two surface tensors $a_{\alpha\beta}$ and $b_{\alpha\beta}$ it is tempting to wonder if it is possible to design any surface, and pattern on it, by freely assign the components of the two tensors. If that was the case, the thesis could very well have ended at this point. However, this is not possible since in order to make the surface fit together one needs compatibility equations that relate the lengths, angles and curvature of the surface and its coordinate net (Stoker 1969), in doing so setting restrictions on the components of $a_{\alpha\beta}$ and $b_{\alpha\beta}$. The first one has been presented already in the Gauss equation. There are two more, and those are the Codazzi or Codazzi–Mainardi equations. Green and Zerna (1968) gives the following definition of the Codazzi equations:

$$b_{\alpha 1}|_2 = b_{\alpha 2}|_1 \quad (2.22)$$

Struik (1988) writes them out as

$$b_{11,2} - b_{12,1} = b_{11}\Gamma_{12}^1 + b_{12}(\Gamma_{12}^2 - \Gamma_{11}^1) - b_{22}\Gamma_{11}^2 \quad (2.23)$$

$$b_{12,2} - b_{22,1} = b_{11}\Gamma_{22}^1 + b_{12}(\Gamma_{22}^2 - \Gamma_{12}^1) - b_{22}\Gamma_{12}^2 \quad (2.24)$$

Since this chapter started describing distances, and how Gauss took a globally curved surface and by looking at a small part could use concepts from Euclidean geometry to compute distances, it might be worth mentioning *geodesics*. Some might have heard about the geodesic domes by Buckminster Fuller (1954). Geodesics are curves on the surface with certain properties. They can be defined in two ways: as the (locally) shortest distance between two points or as curves that have zero curvature in the tangent plane of the surface, which is usually called geodesic curvature. A geodesic curve can be obtained by taking the second derivative of $\mathbf{r}(\theta^1(s), \theta^2(s))$ with respect to unit speed parameter s , and set the components in the tangent plane to zero. Thus, every curve fulfilling the condition in (2.25) are geodesics (P. Dirac 1975):

$$\frac{d^2\theta^\lambda}{ds^2} + \frac{d\theta^\alpha}{ds} \frac{d\theta^\beta}{ds} \Gamma_{\alpha\beta}^\lambda = 0 \quad (2.25)$$

The geodesic equation (2.25) also works in higher order. In the general theory of relativity, the planets move along geodesics in space-time. The following sections will show how differential geometry can be a useful tool in order to describe the form and perform analysis, as well as creating patterns on complex surfaces.

2.1.4 Strength through geometry

Structural engineers J. Schlaich and M. Schlaich (2008) ask the question *How to create lightweight structures?* In their paper *Lightweight structures* they suggest five rules for the design of such structures. In the second rule, J. Schlaich and M. Schlaich emphasises the importance of avoiding bending due to the inefficient stress distribution within the element, compared to pure tension and compression structures utilising the cross-section more efficiently:

Secondly avoiding elements stressed by bending in favour of bars stressed purely axial by tension or compression ... Bending completely stresses only the edge fibres while in the centres dead bulk has to be dragged along. (J. Schlaich and M. Schlaich 2008 p.2)

Figure 2.9 aims to show why that is true. With a point load, p , on a span, l , the beam needs an inner lever arm, e , to ensure equilibrium, while the arch in compression and the cable in tension creates the same lever arm using its geometry. Thus, the arch and the tension uses its material much more efficiently as long as the supports can handle the thrust. However, one issue with compression structures is that they can buckle, which is also true for shells structures as professor Williams (2014) states “The more efficient the shell, the more sudden the buckling collapse” (C. J. Williams 2014, p.31). The buckling can, nevertheless, be increased by, for instance, corrugating the surface, stiffening the shell (Malek 2012). This can be seen in nature in seashells but has also been used in vaults and grid shells such as Weald and Downland Museum. Tension structures are not affected by buckling instability, but require stronger materials like steel. J. Schlaich and M. Schlaich (2008) states in their third rule, timber is stronger in tension than steel relative its density. However, one issue with timber is transferring the load in the connections and making the forces follow its fibres. Compression arches and domes are gentler to the material in that sense; the connections are simple often by use of mortar. However, unreinforced masonry is much sensitive to tensile stresses (Heyman 1995).

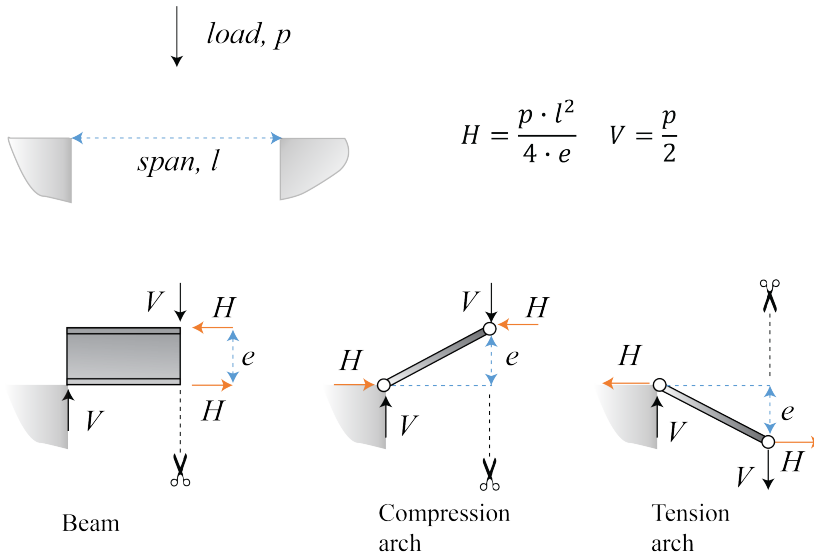


Figure 2.9: Three different possibilities to carry a point load across a span l wide. The beam transfers the load through an internal lever arm. The two arches take advantage of the support to carry load in either pure tension or compression, which is more material efficient. However, the arches require better support conditions, and the compression arch can buckle

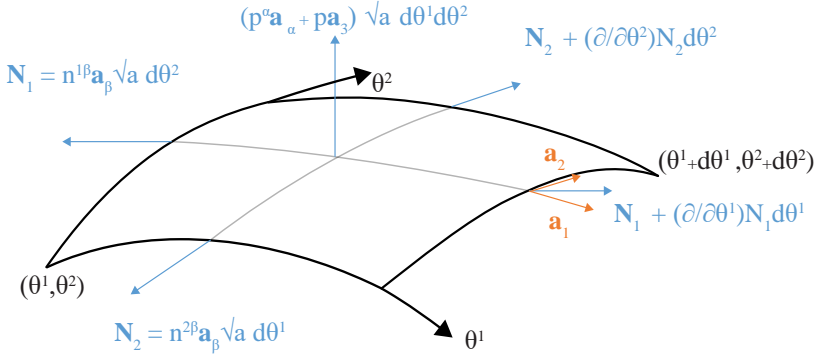


Figure 2.10: *Equilibrium for a general three dimensional membrane element*

In shell theory the use of differential geometry will enable the formulation of the equilibrium equations for curved surface elements. This section will cover the equilibrium equations of membrane theory, which excludes bending. In Green and Zerna (1968) the equilibrium equations for a general membrane element, Figure 2.10, are written:

$$n^{\alpha\beta} b_{\alpha\beta} + p = 0 \quad (2.26)$$

$$n^{\alpha\beta} |_{\alpha} + p^{\beta} = 0 \quad (2.27)$$

where $n^{\alpha\beta} |_{\alpha}$ is the covariant differentiation.

$$n^{\alpha\beta} |_{\alpha} = n_{,a}^{\alpha\beta} + \Gamma_{\alpha\rho}^{\beta} n^{\alpha\rho} + \Gamma_{\alpha\rho}^{\alpha} n^{\rho\beta} \quad (2.28)$$

Green and Zerna uses Einstein notation. Thus, (2.26) contains two expressions using the summation convention, describing the equilibrium in the two directions in the plane of the surface. Equation (2.27) refers to the equilibrium in the direction of the normal. The tensor, $n_{\alpha\beta}$, contains the surface stress tensor components of the membrane element.

$$n^{\alpha\beta} = \begin{bmatrix} n^{11} & n^{12} \\ n^{21} & n^{22} \end{bmatrix} \quad (2.29)$$

and the symbols $\Gamma_{\alpha\beta}^{\gamma}$ are the Christoffel symbols of the second kind in (2.17). The equilibrium equations, (2.26) and (2.27), are described more in detail in (Adiels 2016). The reader might find these equations difficult to interpret and possibly even harder to solve, which is quite natural. As Williams states “Hand calculations for shells are very difficult or impossible. However some understanding of shell theory will help with choice of shell shape and interpreting computer and model test results.” (C. J. Williams 2014 p.31) Today, the most common way of solving these equations is likely using Finite Element Method (FEM) and Isogeometric analysis (IGA), which can be solved using computers. Ottosen and Petersson (1992), gives a good overview of FEM, similar can

be said about Hughes et al. (2005) regarding IGA. As Williams states, shell theory is necessary to evaluate the results from the above. Therefore, the next part will cover how one can solve the membrane stresses for analysis of shells of revolution and shells of translation surfaces using Airy stress function (Airy 1863).

A common branch of shells linked to the traditional shapes of forms applied in architecture and engineering is the shells of revolution. That is shells based on a profile curved rotated around a central axis. Thus, special cases of shells of revolution include the dome and the cone. To describe the membrane element ϕ and θ is used as surface parameters, similar to the spherical coordinates as Timoshenko and Woinowsky-Krieger (1959) and Billington (1965). Figure 2.11 shows the geometrical description of the element where the dotted line the right is the central axis of rotation. What makes shells of revolution so useful, compared to arches, is the possibility of taking forces in the hoop direction, which is the direction of parallel circles stacked along the central axis or θ direction in Figure 2.11. This is the reason Pantheon can have an central opening and it can also be used as a temporary load path during construction. Under symmetrical loads there exist no shear along any of the coordinate curves (ϕ or θ equals constant). No forces are applied in the θ direction which means the two equations in (2.27) can be reduced to one. It results in the two equilibrium equations for a general shell of revolution under symmetrical load, the first for the normal direction and the second for the ϕ direction (Billington 1965; S. Timoshenko and Woinowsky-Krieger 1959). Using the conventions in Billington 1965 those two equilibrium equations are written as:

$$\frac{N'_\phi}{r_1} + \frac{N'_\theta}{r_2} + p_z = 0 \quad (2.30)$$

$$\frac{d}{d\phi} \left(N'_\phi r_0 \right) - N'_\theta r_1 \cos \phi + p_\phi r_1 r_0 = 0 \quad (2.31)$$

In (2.30) it is clear that stresses are proportional to the curvature, $\kappa = \frac{1}{r}$. For the special case of a spherical dome, r_1 and r_2 are replaced with r .

$$\frac{1}{r} \left(N'_\phi + N'_\theta \right) + p_z = 0 \quad (2.32)$$

$$\frac{d}{d\phi} \left(N'_\phi \sin \phi \right) - N'_\theta \cos \phi + p_\phi r = 0 \quad (2.33)$$

In the case of uniform gravity load, it is possible to acquire the stress resultants in (2.32) and (2.33) by solving N'_ϕ through its component in the z-direction. Billington (1965) does so for the case of uniform and and projected load. He uses q for the uniform load and p for the project load, both in load per unit area. The solutions for both cases are plotted in Figure 2.12. The angle of which the hoop stresses go from compression to tension are indicated since it is important for masonry domes. For the imaginary case of a half spherical dome of radius 100 meters and a self-weight of 25 kN/m^2 , one would get stresses maximum stresses of 2.5 MPa . Thus, the low stresses shows why shells can be extremely structurally efficient.

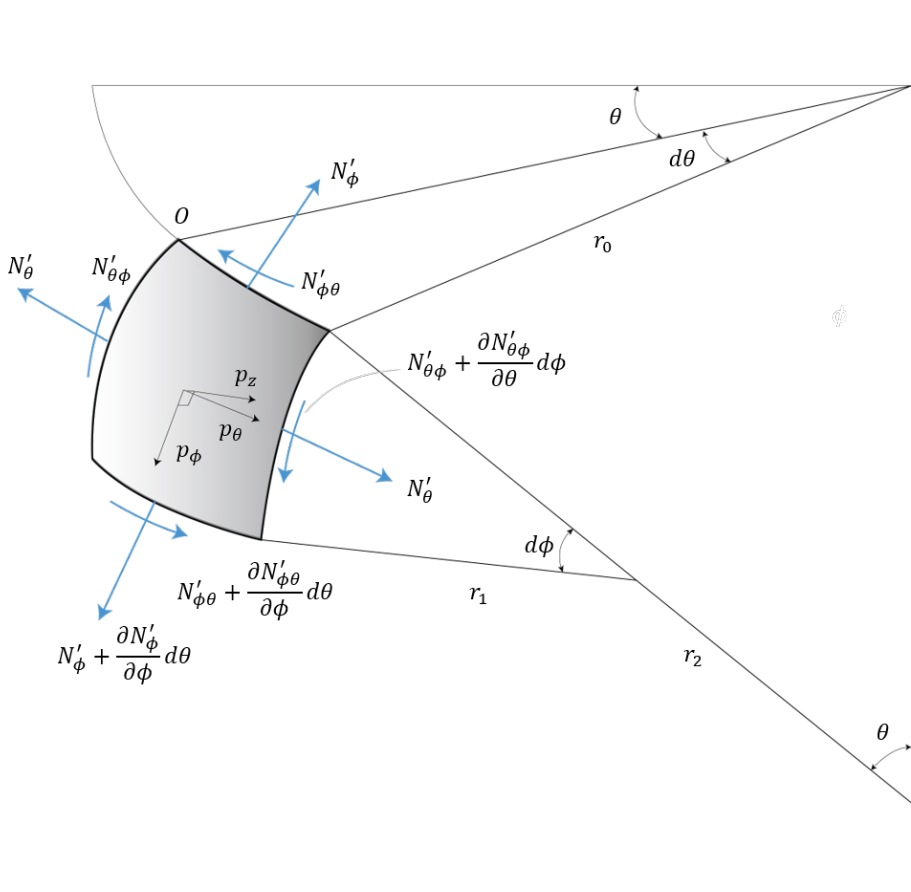


Figure 2.11: *Shell of revolution, redrawn from Billington (1965)*

As described in Green and Zerna (1968) it is sometimes useful to have the equilibrium equations projected on the plane surface. If body forces are zero or constant one can reduce the three equations of equilibrium to one differential using a stress function (Airy 1863; S. Timoshenko 1934). In Green and Zerna (1968) this is described equation 11.2.11 using ϕ as the stress function:

$$\epsilon^{\alpha\gamma}\epsilon^{\beta\rho}z|_{\alpha\beta}\phi|_{\gamma\rho} = q \quad (2.34)$$

where q contains the loading acting on the shell. The inplane stresses can be obtained from the stress function using equation 7.5.5 in Green and Zerna (1968).

$$n^{\alpha\beta} = \epsilon^{\alpha\gamma}\epsilon^{\beta\rho}\phi|_{\gamma\rho} \quad (2.35)$$

Equation (2.34) contains 16 terms since it has four summation indices. The components

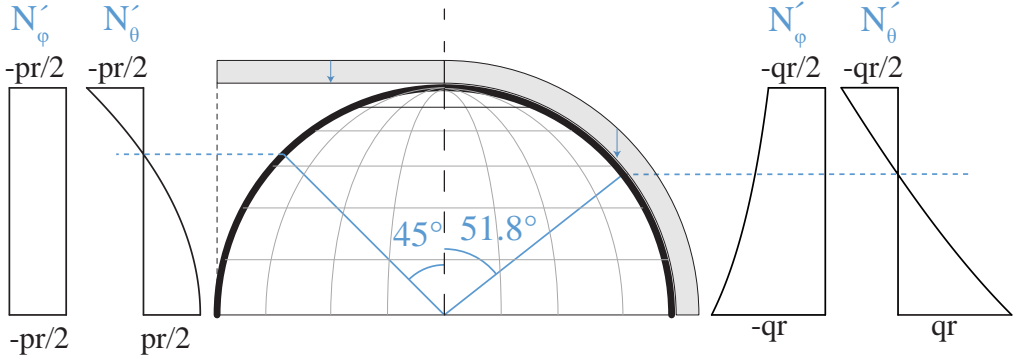


Figure 2.12: *Stresses in a dome, left shows for the projected load and the one the right the stresses of a dome under self weight*

of the psuedo-tensor are defined in (2.14). Thus, it is possible to reduce (2.34) to

$$\epsilon^{21}\epsilon^{21}z|_{22}\phi|_{11} + 2\epsilon^{12}\epsilon^{21}z|_{12}\phi|_{12} + \epsilon^{12}\epsilon^{12}z|_{11}\phi|_{22} = q \quad (2.36)$$

Choosing a Cartesian coordinate system, i.e. $\sqrt{a} = 1$, which means (2.36) can be simplified to:

$$z_{,22}\phi_{,11} - 2z_{,12}\phi_{,12} + z_{,11}\phi_{,22} = q \quad (2.37)$$

This a second order partial differential equation that is either elliptic or hyperbolic depending upon whether the Gaussian curvature is positive or negative. In the special case of a developable surface of zero Gaussian curvature the equation is parabolic. In the case of negative Gaussian curvature a point load produces concentrated forces which travel along the asymptotic lines to the supports. In the case of positive Gaussian curvature the stresses due to a point load die away as you move further from the load. This explained elegantly by professor Heyman in his lecture to the Escuela Tecnica Superior de Arquitectura de Madrid (Heyman 2015). The wave equation in one spatial direction is hyperbolic whereas Laplace's equation is elliptic. An example of a parabolic differential equation is one dimensional non-steady heat flow, whereas two dimensional steady heat flow obeys Laplace's equation. Equation (2.37) is the same as in Timoshenko and Woinowsky-Krieger (1959, p.462) and (7-8) in Billington (1965), but instead of ϕ they use F .

$$\frac{\partial^2 F}{\partial x^2} \frac{\partial^2 z}{\partial y^2} - 2 \frac{\partial^2 F}{\partial x \partial y} \frac{\partial^2 z}{\partial x \partial y} + \frac{\partial^2 F}{\partial y^2} \frac{\partial^2 z}{\partial x^2} = q \quad (2.38)$$

Using Figure 2.13 it is possible can write out the projected in plane stresses in (2.35) similar as Timoshenko and Goodier (1934)

$$\bar{N}_x = \frac{\partial^2 F}{\partial y^2}, \bar{N}_{xy} = \frac{\partial^2 F}{\partial x \partial y}, \bar{N}_y = \frac{\partial^2 F}{\partial x^2} \quad (2.39)$$

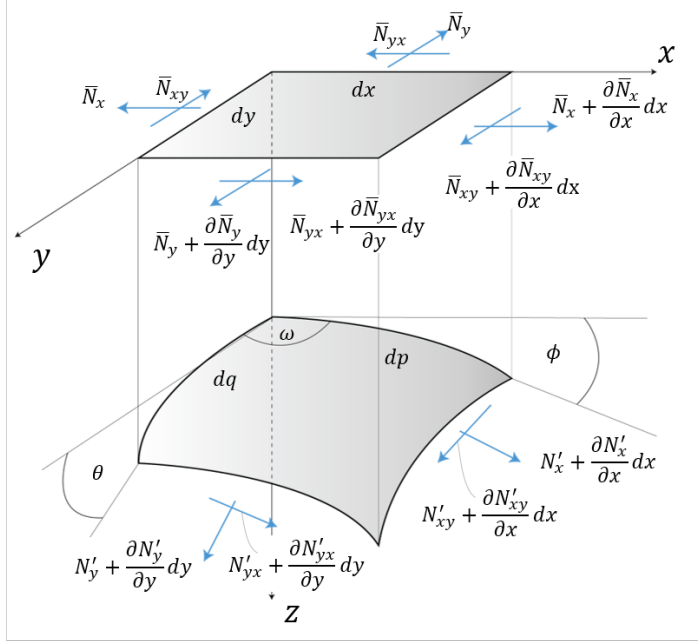


Figure 2.13: Airy stress function for membrane shells, redrawn from Billington (1965)

which is the same as (2.35). Specifying the shape, referring to x, y, z in (2.38), it is necessary will have to find a solution to F such that it fulfils the boundary conditions and equilibrium. As an example, found in Billington (1965) using a elliptical paraboloid , see grey surface in Figure 2.14, which can be described geometrically as (cf. Figure 2.14),

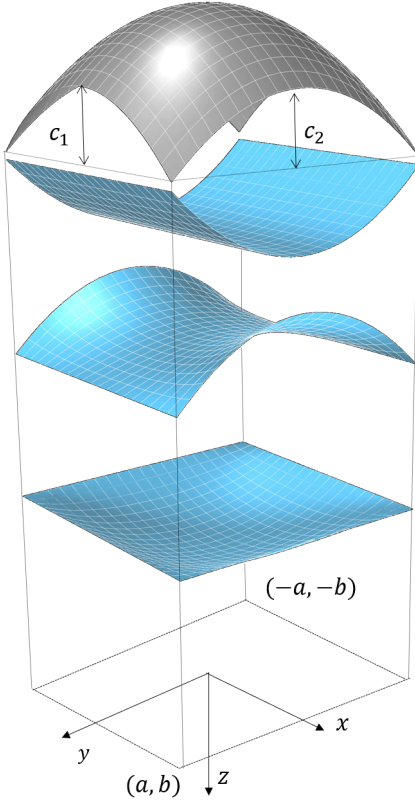
$$z = y^2/h_2 + x^2/h_1, h_1 = a^2/c_1, h_2 = b^2/c_2 \quad (2.40)$$

The shell is loaded in the z -direction with a load described by the projected surface area. There are several solutions to the stress function F that fulfils the boundary conditions. There are two simple solutions in which the load is carried in arch action in either the x - and y -direction such as

$$F = \frac{1}{4} \bar{p}_z h_1 (b^2 - y^2) \quad (2.41)$$

However, Timoshenko and Woinowsky-Krieger (1959) and Billington (1965) add a term which describes a more efficient stress distribution:

$$F = \frac{1}{4} \bar{p}_z h_1 (b^2 - y^2) + \sum_{n=1,3,5}^{\infty} A_n \cosh \beta x \cos \lambda y \quad (2.42)$$



$$z = \frac{y^2}{h_2} + \frac{x^2}{h_1},$$

$$F_0 = \frac{1}{4} p_z h_1 (a^2 - x^2)$$

$$F_1 = \sum_{n=1,3,5..}^{\infty} A_n \cosh \beta x \cos \lambda y,$$

$$F = F_0 + F_1$$

Figure 2.14: Two solutions for the Airy stress function, blue surfaces, for an elliptical paraboloid shell, in grey

Where A_n and β are defined as:

$$A_n = -\frac{2\bar{p}_z a^2}{c_1 \pi n} \frac{1}{\lambda^2} \frac{(-1)^{(n-1)/2}}{\cosh \beta a}, \beta = \frac{n\pi}{2a} \sqrt{\frac{c_1}{c_2}}, \lambda = \frac{n\pi}{2b} \quad (2.43)$$

Plotting (2.41) and (2.42) in relation to the geometry, Figure 2.14, it is possible to visualise stress surfaces, similar to the energy and equilibrium surfaces described poetically by McRobie (2017) in chapter 1.

So far in the presented examples, the geometry, or form, has been assumed fixed while the stresses have been determined by the choice of stress functions. The reverted problem would be to find a form fulfilling equilibrium when the stress function is predefined. That is what is usually called *form finding* (Happold and Liddell 1975), seeking a form that is in equilibrium with the load in a preferable state or stress, usually meaning reducing amount bending in favour the membrane action as described by J. Schlaich and M. Schlaich (2008). Form finding has been performed long way back, as seen in flying buttresses and rib vaults in Gothic cathedrals and the geometrical rules by Derand, Figure 2.6. The

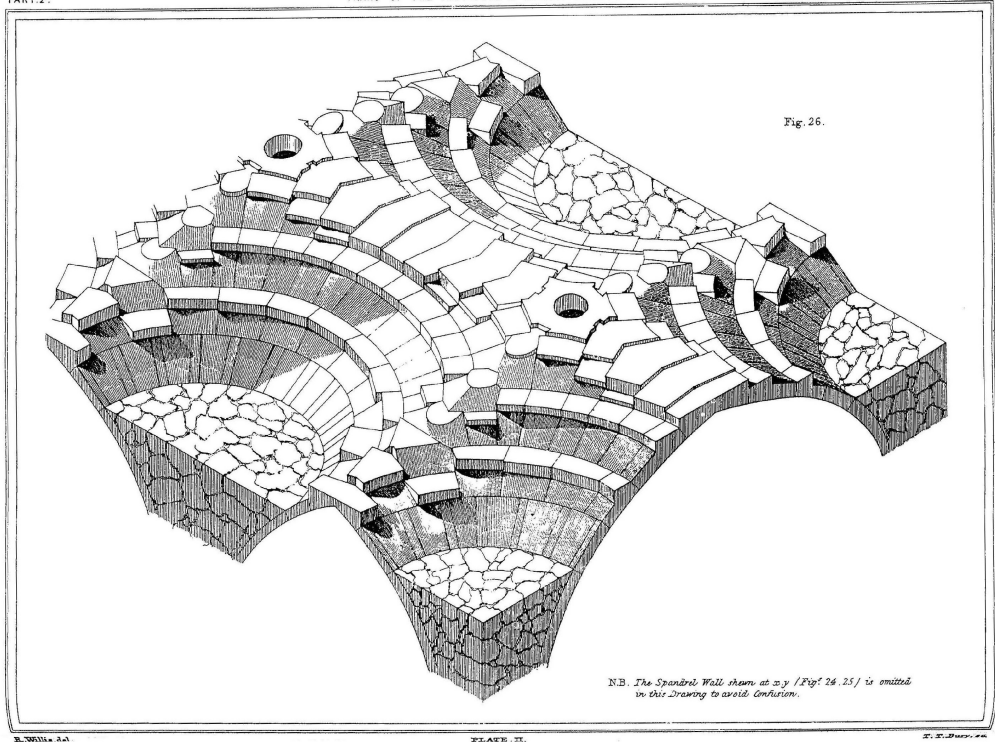


Figure 2.15: *The complex construction of the fan vaults in Peterborough Cathedral illustrated by Willis (1842)*

academic interest in finding the most efficient form of an arch goes back to Robert Hooke and James Bernoulli (Benvenuto 1991). Architects like Gaudí (Collins 1963) and Frei Otto (Happold and Liddell 1975) used physical models to find these forms. During the 20th century, numerical methods for form finding. In (Veenendaal and Block 2012) they categorize these in three families: *stiffness matrix methods*, *geometric stiffness methods*, *dynamic equilibrium methods*. The geometric stiffness originates from the work of *Force Density Method* of Linkwitz and Schek (1971; 1974). The dynamic equilibrium methods include *Dynamic Relaxation* originates from the work by Alistar Day (1965) and Barnes (1977).

2.1.5 Rational construction through geometry

In the previous section it was shown why geometry is the most important factor for structural efficiency. What is then the drawback? J. Schlaich and M. Schlaich describes the manufacturing and construction of double-curved surfaces as complex:

Expensive formwork and complicated cutting patterns are required for the manufacture of these double-curved surfaces. The details of tensile structures

and membranes are complicated and have to be manufactured with extreme precision. (J. Schlaich and M. Schlaich 2008, p.5)

Similar complexity in construction is valid for other types of double-curved structures, such as masonry and concrete vaults, as shown in section 2.1.2, and steel and timber grid shells. Heyman (2015) claims that only four large cathedrals were constructed with fan vaults, as seen in Peterborough Cathedral, Figure 2.15, since they were so complicated to build and expensive to manufacture. Fitchen (1961) describes and emphasises the difficulty in constructing false work during medieval times and that it has not got enough attention when evaluating these structures. Fitchen argues that the rib vaults in the Gothic Cathedrals had an essential contribution to lowering the cost for labour in terms of easier connections and less timber work than the Romanesque groin vaults. The only preserved medieval centering is in the tower of the Lärbro church in Sweden from the 13th-century (Frankl 1962).

There have been different ways to achieve a more cost efficient construction in history, including the use of standardised or simple building elements and methods to assemble and raise the structure more easily. The brick mould can be seen in wall paintings from Egyptian tombs dating to ca. 1450 B.C, Figure 2.16, but it was likely invented much earlier and not in Egypt, maybe as early as around 5900-5300 B.C (Campbell 2003). Rottlaender

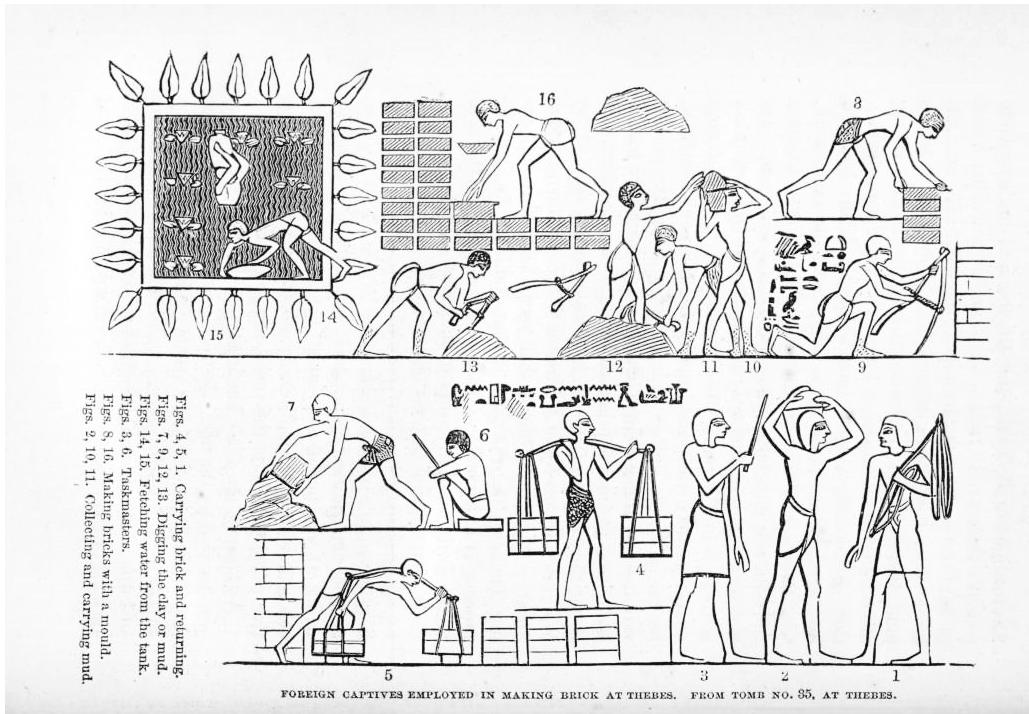


Figure 2.16: From wall painting in the tomb of Rekh-mi-Re (1450 B.C) illustrating the process of manufacturing bricks of mud and straw using brick moulds, (Prime 1860)

(1977) presents tables of measurements from masonry buildings in ancient cities of Tepe Yahya (5-4 millennium B.C) Uruk (4 millennium B.C.) where the building blocks are standardised, having a mean value of a cubit. Spanish originating architects and master builders such as Antoni Gaudí, Lluís Domènech, Eduardo Torroja, Rafael Guastavino Sr. and Rafael Guastavino Jr. mastered designing using the brick and the brick tile. Using thin tiles in combination with fast setting gypsum mortar they could build vaults using little or any formwork (Collins 1968; Ochsendorf 2010), a technique traditionally common in Spain and the region of Roussillon in France (Bannister 1968). Gaudí used the brick tiles in creative ways, such as the attic in Bellesguard, Casa Vicens and Crypt at Colonia Güell. Guastavino Sr. and Rafael Guastavino Jr. built many vaults and domes in iconic public buildings in America during the end of the 19th century and the first half of the 20th century. In the Sancti Petri Bridge, Eduardo Torroja used steel-reinforced brick shells, Figure 2.17 (Ochsendorf 2003). Instead of using bricks, Schlaich Bergermann



Figure 2.17: *Eduardo Torroja using thin brick shells as form-work for the foundations of the Sancti Petri Bridge, 1927*

Partner designed shells with planar glass panels in the house for Hippopotamus at Berlin Zoo (J. Schlaich and Schober 1996; J. Schlaich and Schober 2005), Figure 2.18. The form are described as translational surfaces that offer the possibility to define the two boundary curves, the directrix and the generatrix, arbitrarily — offering a wide variety of shapes

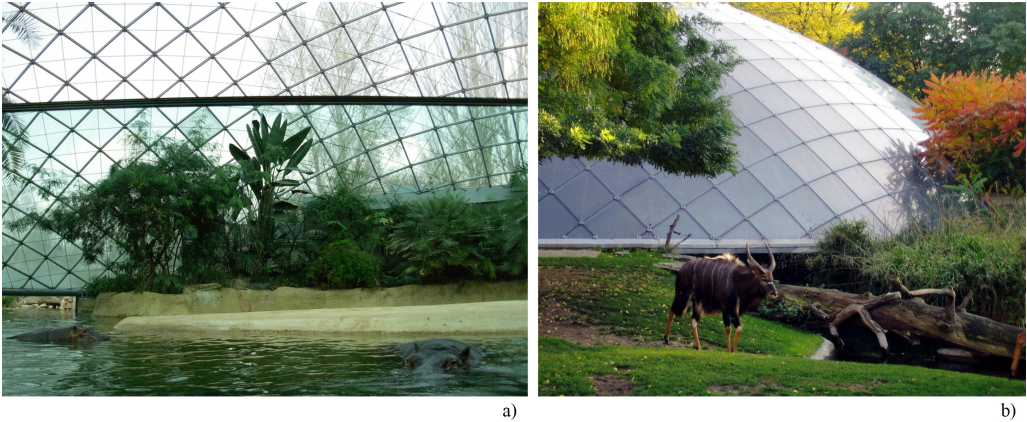


Figure 2.18: *The House for Hippopotamus at Berlin Zoo, a) interior view and b) exterior view. The curved shape was designed such that it could be made from planar quad panels. Schlaich Bergermann Partner, 1996*

that can be manufactured from planar quadrangular panels sheets. Master builder Rafael Guastavino Sr. also used translational surfaces in his tile vaults. First, his craftsmen built the edge arches and to later disassemble the centering, letting it slide along the arches as a temporary falsework while filling the void, see Figure 2.19. Simple building elements can be incorporated into grid shells as well, shown in the double layer timber grid shell in Mannheim, Figure 2.20, by Frei Otto, Ian Liddell and Edmund Happold. The grid is an equal mesh net built out of straight timber laths. The grid was built flat on the ground to be lifted, bent and locked into place, giving the shell action. Equal mesh nets are nets where the lengths of the edges of each cell in the grid are of the same length, also called Chebyshev nets after the Russian mathematician Chebyshev (1887/1946). Chebyshev applied, what he called the mathematics by Gauss, to solve the matter of cutting patterns on clothes. One can see this as a purely mathematical problem of dressing a surface with a certain pattern. As mentioned in section 2.1.3, it is not possible to decide the properties of the form and the pattern using the components of the metric tensor, $a_{\alpha\beta}$, and the components of the surface tensor $b_{\alpha\beta}$. That is due to the three compatibility equations, usually referred to as the Gauss-Codazzi equations (Stoker 1969). In a Chebyshev net one specify the metric tensor components as (C. J. Williams 2014):

$$a_{11} = L^2 \quad (2.44)$$

$$a_{22} = L^2 \quad (2.45)$$

$$a_{12} = L^2 \cos \omega \quad (2.46)$$

Where the length L is constant and ω is the angle between the two basis vectors. The Gauss theorem becomes (C. J. Williams 2014):

$$K = -\frac{1}{L^2 \sin \omega} \frac{\partial^2 \omega}{\partial \theta^1 \partial \theta^2} \quad (2.47)$$



Figure 2.19: Master builder Rafael Guastavino standing on a recently finished arch during the construction of the Boston Public Library, 1889

If the angle ω is constant, the surface must have zero Gaussian curvature, meaning that it is either flat or something that can be formed from a flat sheet of paper without deforming it, such as rolling it to a cylinder. So for other types of curved surfaces, this angle must be allowed to vary. However, it possible to combine these geometrical properties with the physical properties described in membrane theory, as in form finding. The three tensors, $a_{\alpha\beta}$, $b_{\alpha\beta}$ and $n^{\alpha\beta}$ has nine unique components and there are six equations; the Gauss-Codazzi equations (2.20), (2.23), (2.24), and the three equilibrium equations (2.26), (2.27). Thus, a solution require three choices which can be used to describe sought properties of the form, pattern or state of stress. In the case of the Mannheim grid-shell, an equal mesh net are described as (Adiels 2016):

$$a_{11} = L^2 \tag{2.48}$$

$$a_{22} = L^2 \tag{2.49}$$

$$n^{12} = 0 \tag{2.50}$$

Equation (2.50) sets the shearing to zero, constraining the state of stress to follow lines in

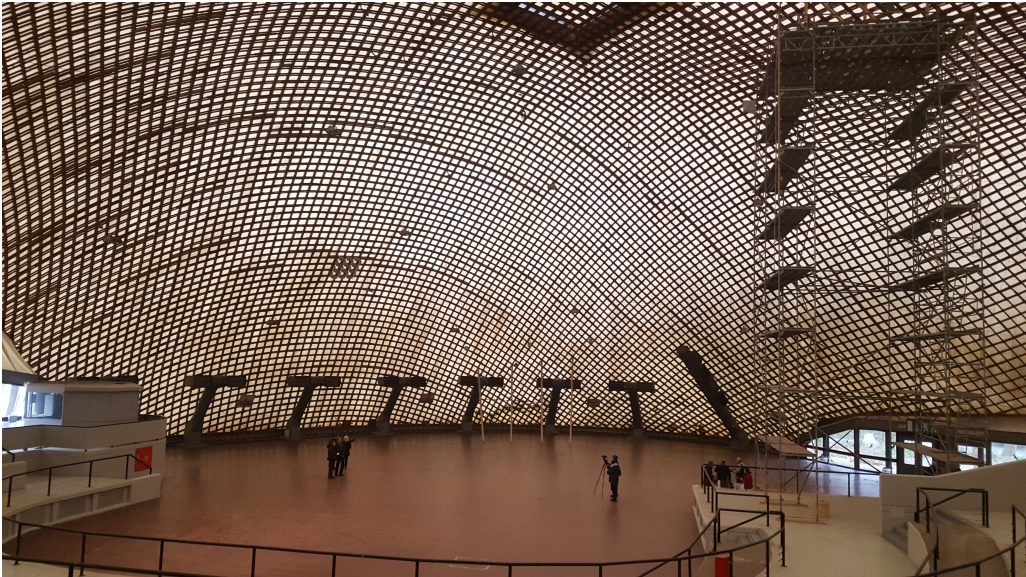


Figure 2.20: *Timber grid shell in Mannheim Multihalle, Germany*

the grid. Such that the sheet of paper described above turns into a fishing net allowing to be a curved surface, i.e. Gaussian curvature not zero. Thus, it is possible solves the remaining six unique components of the three tensors using numerical methods such as dynamic relaxation. Williams (1980) uses a similar approach to cutting patterns of inflated membrane structures but instead using geodesic coordinates.

This last example ties back to the beginning with the weaver, of which Struik (1987) describes gave birth to geometry, described with the same type of equations that also describe the space-time fabric of the Universe.

2.2 A sustainable building culture

This section will cover the aspects of the building culture and the impact and connection to sustainable development. Furthermore, the Davos declaration calling for a high-quality Baukultur signed by the European Ministers is introduced is presented. Moreover, the meaning of and the components of craftsmanship is described and placed in a contemporary context. Furthermore, the hand and head relationship and the connection between creativity and learning is studied. Lastly, it treats the activities in which we work together and the place of the medieval workshop in a modern setting.

2.2.1 What is a sustainable building culture?

As Bill and Melinda Gates (2019) and states one of the major challenges for the building industry is to find a way to reduce the GHG emissions with respect to the environment



Figure 2.21: *Temporary roof structures over the Biete Mariam Rock Church in Lalibela, Ethiopia, funded by the European Union*

and climate change (IEA 2019). As Hedenus et al. (2018) describe, wicked problems such as climate change are not solved through single parameter nor by a single actor or a single technical advancement; it is more complex than that. It is also important not to forget the economic and social dimension of sustainable development talking about climate change. Thus, Hedenus et al.(2018) state, to be successful with environmental goals, incorporating all three dimensions of sustainability, will require broad collaborations and three areas necessary for success: *systems thinking*, *cross-disciplinary work* and *insights in ethics*. With systems thinking, they mean that the system contains several parameters or aspects that are linked in a complex weave. It includes an understanding of the context. In an architectural context, it might be to adapt the design to local labour, knowledge, skills, available technologies and local materials (Block, Davis, et al. 2010). In complement to the environmental benefits, it can potentially contribute to the economic and social dimension of sustainability by maintaining knowledge and skills developed over a long time. One might call this developing and maintaining a good building culture. To address the importance of good building culture, one can use the UNESCO protected The Rock-hewn Churches of Lalibela in Ethiopia as an example. The European Union funded temporary roof structures or shelters whose purpose was to reduce the deterioration from water onto the churches. The local community is experiencing that the heavy steel structures covering the churches, Figure 2.21, are doing more harm and are afraid they will collapse



Figure 2.22: *Mapungubwe Interpretation Center*. Team: *Peter Rich Architects, Michael Ramage at Cambridge University and John Ochsendorf at MIT*

(Woldeyes 2018). They also feel powerless and incapable of solving these problems or take the structure down themselves. From the *Preliminary Report: Conservation Concerns for the Lalibela Rock Hewn Churches*:

The E.U. funded shelters have introduced a vicious cycle of dependency on foreign experts. Clearly, it is beyond the capacity of the local people to sustain or remove such protection measures. (Woldeyes 2018, p.17)

In the report, the local communities' expresses the frustration they feel being excluded in the design process and dependent on external actors that do not keep their promises. Similar concerns by the local community can be read in the report presented by UNESCO/ICOMOS/ICCROM (2018). Thus, the option of dismantling shelters are considered in the report. Aside from the tragedy of their cultural heritage that are at risk of being damaged, it also lowers the trust in institutions and external collaborators, referred to as the vertical relations by Hedenus et al. (2018). Examples of the opposite are *The Mapungubwe Interpretive Centre*, Figure 2.22, in South Africa and the low-cost family dwelling built in Ethiopia by Sustainable Urban Dwelling Unit (SUDU) (Block, Davis, et al. 2010), where the local community has been invited in the construction process, potentially increasing the so-called horizontal relations described in Hedenus et al. (2018), and utilised local resources such as compressed earth tiles. Ramage et al. (2010) describes how ecological and economic benefits have been integrated in the project in Mapungubwe:

At Mapungubwe, the labour intensive construction reduced polluting machinery (sourced from far) and replaced it with small format construction methods that have minimal impact on the surrounding environment. This intensive construction involved skills training which has had a positive impact on the socio-economics of the local area, consistent with government strategies for targeting development to local communities. The government-funded poverty reduction programme employed a 60 people to make tiles for a year. Constructing the vaults trained over 100 people and employed 10-40 people at any one time over the course of 8 months. By using thin tile vaults instead of reinforced

concrete at Mapungubwe, we saved an estimated 9 m³ of steel, resulting in an embodied energy savings of almost 120,000 kg CO₂ emissions for manufacture alone, and using local earth bricks instead of fired clay obviously saved the energy that would have been used to fire over 200,000 tiles. (Ramage et al. 2010, p.22)

It shows how not only architects but engineers can have a holistic view and make designs adapted to the context, which can contribute to all dimensions of sustainable development. From the two examples, it is clear that a building culture needs to include the design and construction and the associated processes of the making. In order to reach the environmental goals, described in Hedenus et al. (2018), it is important to have a good building culture but how to measure and define it? Another issue is that the cultural values, in general, are rarely defined in an international political context. That is one reason behind the 2018 Davos declaration, signed by the European ministers of culture, aimed to formalise a framework regarding such goals within the built environment and the need for holistic solutions incorporating the immeasurable values essential for neighbourhoods their inhabitants.

2.2.2 Davos declaration and Baukultur

To raise the awareness of the importance of culture for future sustainability, the European Ministers of Culture signed the Davos Declaration 2018 (Swiss federal Office of Culture 2018b). The ministers call for high-quality *Baukultur*, a word used in German that is linked to architectural quality, but more inclusive. *Baukultur* also addresses that it is not only the final product that is important but also the process behind it, how it is made and how it contributes to the common good. The two examples in section 2.2.1 are evidence on this. In the Davos declaration 2018 The concept of a *Baukultur* is defined as (Swiss federal Office of Culture 2018b):

1. The existing construction, including cultural heritage assets, and contemporary creation must be understood as a single entity. The existing construction provides an important *Baukultur* reference for the future design of our built environment.
2. All activities with an impact on the built environment, from detailed craftsmanship to the planning and execution of infrastructure projects that have an impact on the landscape, are expressions of *Baukultur*.
3. *Baukultur* not only refers to the built environment but also to the processes involved in its creation.

The first point highlights one of the privileges of architects, structural engineers, craftsmen, and craftswomen. Through preserved buildings and structures, it is possible to connect to and learn from dead colleagues of previous generations. Even though the future is unknown, it is possible to evaluate the past. For instance, in the United Kingdom, many masonry bridges have survived which are still in service, even though they were not designed for the current loads, and they have in some senses, according to McKibbins et al. (2006) performed better over time than many modern in concrete and steel:

Masonry arch bridges can be viewed as among the most sustainable structures ever to have been built. Many have already been in service for hundreds of years without significant repair or strengthening works — exceeding the design life requirements of modern structures. By contrast, many of the steel and concrete bridges built in the last century have required considerable expenditure on maintenance and repair or even replacement within the first 30—40 years of service. A recent review of funding required for bridge and retaining wall maintenance carried out by the Bridges Group of the County Surveyors Society (CSS, 2000) which involved several methods of assessment, suggested that the annual maintenance cost of masonry arch bridges appeared to be much lower than for other bridge types, and half that of steel bridges with reinforced concrete supports. Other studies have produced similar results (Bouabaz, 1990; CSS, 1999). (McKibbins et al. 2006, p.25)

The lessons from McKibbins et al. (2006) would have been difficult if the bridges were not preserved. The long term consequences spanning hundreds or thousands of years are difficult to estimate in theory or through experiments in the lab. One way of seeing historic structures is as long-term experiments; to continuously learn from and reflect current practices and structures against them. As in the example in Mapungubwe, they designed based on historic principles similar to the masonry bridges, using labour intensive but also structurally efficient forms to be able to build with earth tiles that are structurally weak in tension but require less energy in manufacturing.

The third point involves both the design and the construction process. In the context document to the Davos declaration, they motivate public inclusion due to:

Including the population in decision-making processes promotes the identification of communities with their built environment and strengthens their sense of shared responsibility for their surroundings; on the other hand, however, it also requires the population to have an awareness of questions of quality and construction and the ability to understand them. (Swiss federal Office of Culture 2018a, p.8)

In Mapungubwe the inclusion of the locals, according to Ramage et al. (2010), added value not only to the structure but to the community in both social and economic aspects. The report from Lalibela (Woldeyes 2018) highlighted the consequences of not including the local community in either the design or construction process.

The second point in the Baukultur definition involves detailed craftsmanship. According to professor Sennett (2016) there is an important difference between craft and craftsmanship. “A craft is usually thought of as a manual activity. Craftsmanship is thought of as quality work. And more than that, doing good work for its own sake ... Craftsmanship is a quality embedded in the making” (5:18). In the next section, some lessons from the culture of craftsmanship should be addressed and what to learn in an emerging era of digital craftsmanship.

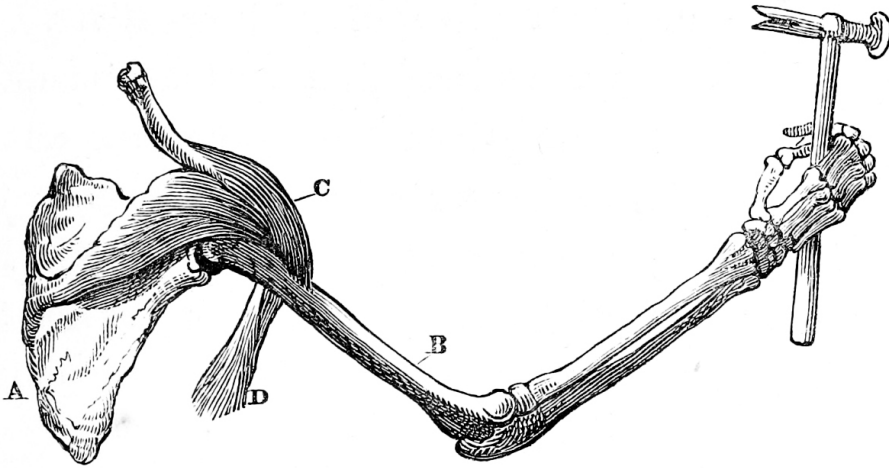


Figure 2.23: *It is not only the hand, but the entire mechanism together with the arm and the dialogue with the brain that has been vital in the human evolution (Bell 1834)*

2.2.3 The hand and brain relationship - Towards a digital craft

Sennett (2008) define craftsmanship as the will to do good work for the sake of good work, going beyond the economic benefits of the individual. The quality of work that is rewarding and makes the craftsman develop his skills. It can go beyond the point in which it becomes an unhealthy obsession for him or herself. In the Swedish and German language, a craftsman is in etymological meaning a person working with their hands. Though, Sennett does not differentiate between a carpenter and a doctor in his craftsmanship definition. However, Sennett and neurologist the Frank R. Wilson mentions the importance and success story of the *hand to head marriage*. This is described in the book *The Hand - How Its Use Shapes the Brain, Language and Human Culture* by Wilson (1998) showing how the hand possibly has played a significant role in the development of languages, social cultures, and human cognition. The idea of the significance of the hand and the head relationship is not new. The Scottish anatomist Charles Bell described the hand as an instrument of the mind and its importance for our 'universal dominion' (Bell 1834). Charles Darwin is credited to point out the essential evolutionary stage in our development of upright posture freeing our hands to do other things (Darwin 1871). With the hands free from supporting our weight, the hand developed for more advanced and intricate features. However, to benefit from the hand, the entire mechanics of the arm also needed redevelopment. The more complex mechanical system of the hand and arm the brain, like a computer, needed to increase its capacity to accommodate this added functionality and freedom of movement (Wilson 1998), Figure 2.23. Therefore, Wilson describes the possibility that the brain and the hand has developed simultaneously with each other, and hence it exists is a mutual exchange between them, a dialogue. Wilson

also addresses the connection to creativity, and possibly why it is rewarding on a personal level.

The more one looks, the more it appears that the revolutionary hand-brain marriage qualifies as one of the defining and unifying themes of human paleoanthropology, of developmental and cognitive psychology, and of behavioral neuroscience ... Seymour Sarason has illuminated the crucial link between the hand and the intelligent action in his exploration of the meaning of creativity. The creative impulse, which is deeply personal, is a critical element at the core of all learning. (Wilson 1998, p.291)

One of the main messages in Wilson (1998) might be that is difficult, or impossible, to dissect the knowledge of the brain from the body. The knowledge involves the entire body since that is how it have been programmed as we have developed. He ends his book with the advice to teachers or parents that want to increase their children's or students curiosity and learning *to head for the hands*, as in Figure 2.24. Another aspect that



Figure 2.24: Weaver and artist, Alison Martin, teaches bachelor students at the Architecture and Engineering program the, in a workshop around traditional weaving and digital tools organised by the author together with D. Jonsson, S. Malmsten, A. Martin, I. Näslund, R. Oval, E. Poulsen and C. J. K. Williams

Sennett (2008) emphasises is the difference and interplay between problem solving and *problem finding*. The craftsman is not only interested in solving the problem, but for each problem solved, it reveals new avenues of problem or investigations to deal with. In such way, the craftsman and craftswoman constantly develops knowledge and skills in a life long learning.

The good craftsman, moreover, uses solutions to uncover new territory; problem solving and problem finding are intimately related in his or her mind. For this reason, curiosity can ask, "Why?" and well as, "How?" about any project. The craftsman thus both stands in Pandora's shadow and can step out of it. (Sennett 2008, p.11)

In the aspect of learning Sennett (2008) highlights the importance of repetition in skill development. Sennett refers to a quote by architect Renzo Piano from *Why architects draw* by Robbins (1997). In which Piano describe the repetitive and iterative nature of drawing and redoing in the design process. A process Piano compares to that of a craftsman:

Drawing is one of the moments of the theoretical process of architecture. It is a concrete process. You start by sketching, then you do a drawing, then you make a model, and then you go to reality—you go to the site— and then you go back to drawing. You build up a kind of circularity between drawing and making and then back again. This is very typical of the craftsman's approach. You think and you do at the same time. You draw and you make. And I find it quite interesting that drawing as a pure instrument of a circular process between thinking and doing, drawing is in the middle but it is revisited. You do it, you redo it, and you redo it again. (Robbins 1997, p.126)

This is similar to what Donald Schön(1992) describes as *reflection in action*, a kind of conversation or dialogue the architect, the designer or the craftsman has with their creation in the making:

This process of seeing-drawing-seeing is one kind of example of what is meant by the phrase designing as a reflective conversation with the materials of a situation. (Schön 1992, p.5)

Sennett (2008) argues that the experimental rhythm of skill development is the trial and error method working with the resistance, in doing so reflect and get a better understanding of the problem and process. That the resistance is important in making people learn and think about what they are doing, discovering the many possibilities of solving the problem. Sennett argues that the multiple ways of solving the same problem separate the craftsmanship from a one-way mechanical solution (Sennett 2016). Similarly, Schlaich (1991) argues that equally qualified structural engineers will find different structural solutions given the same task and scope. Sennett (2008) describes that the same type of reflection in action and rhythm is seen in code development, taking the open-source Linux programmers, crafting in code as an example:

The code is constantly evolving, not a finished and fixed object. There is in Linux a nearly instant relation between problem solving and problem finding. Still, the experimental rhythm of problem solving and problem finding makes the ancient potter and the modern programmer members of the same tribe. (Sennett 2008, p.11)

Wilson (1998) has two quotes from two backhoe operators describing that the backhoe becomes an extension of the arm and they become *one with the machine*, as in Figure 2.25. Wilson also includes an interview with Anton Bachleitner, director of the Düsseldorf Marionette Theater. Bachleitner expresses that the puppeteer needs to feel the puppets' movements on the ground to make them feel realistic. He adds that the best puppeteers can live in the puppet's head and look through their eyes. Can the digital craftsman or programmer develop the same bond with his machine and his code, as an extension of his hands and mind?



Figure 2.25: *Crane operator can exhibit the feeling of becoming one with the machine and that the hydraulic arm becomes as an extension of their real arm*

2.2.4 Machines, a friendly tool or an enemy?

Are machines a friendly tool or an enemy replacing work of the human hand? This question is posed by Sennett (2008). The last decade's architects and engineers have become more dependent on computers and digital tools and aids in their job. It makes their day to day work easier. However, history shows that all professions that have embraced machines have seen them be replaced (Sennett 2008), and we are now entering a time where machine learning and artificial intelligence infiltrate the creative domain. In Wilson (1998) there is an expressed danger in distancing from the 'real world', through a digital layer, that learning and knowledge incorporate the whole body. However, Sennett



Figure 2.26: *The roof at Cambridge Mosque consisting of a complex free-form timber framework, composed of single and double curved glulam beams. Team: Marks Barfield Architects, SJB Kempter Fitze AG, Blumer Lehmann and Design-to-Production*

argues that it is probably best not to fight against the machines but learn how to work with them. A similar position can be read in the 2018 Davos declaration, new technologies and local and traditional, should not be opposites, but rather coexist:

Thus, Baukultur refers to both detailed construction methods and largescale transformations and developments, embracing traditional and local building skills as well as innovative techniques. (Swiss federal Office of Culture 2018b, p.9)

In an architectural context, innovative techniques might include interactive digital tools linked to computer-aided design (CAD), computer-aided engineering (CAE) or computer-aided manufacturing (CAM), and digitally controlled manufacturing technologies, such as 3d-printers (Rippmann et al. 2018), robotics (Dörfler, Sandy, and Giftthaler 2016) and CNC-machines. In such a case, one can use two examples to show two different approaches where traditional skills have been integrated with innovative techniques or technologies. The first example is the new mosque in Cambridge designed and built using free-form glulam timber members produced by Blumer-Lehmann, Figure 2.26. It is a project

where advanced digital modelling and digital manufacturing, have played a vital role, similar to the traditional stereotomy in carpentry. The project included former carpenters now utilising their knowledge working as structural engineers, computational specialists. The project was presented at a seminar at the Chalmers University of Technology in 2019. Their former experience as carpenters was highlighted as an important aspect in their current profession. Johannes Kuhnen, working with the digital craftsmanship at *Design-to-Production*:

As a trained carpenter, I realised early enough what production is really about. Then I studied architecture and learned programming – so that today, in cooperation with fabricators, I am able to implement robust processes for digital production. (Chalmers 2019)

However, one aspect to regard is the democratic one, of ownership of technology and tools. The technology used in the previous example might not be affordable nor accessible to everyone. There is a democratic aspect of, for instance, bricklaying where the tools, unlike other similar crafts, have not changed much. With a trowel, a hammer, a bucket and a spirit level, it is possible build most parts of a house. Thus, there is another option where cheap digital technology can help or assist the skilled craftsmen still utilising their tacit knowledge in manual labour, with cheaper technology and the possibility of sharing code, drawings and software freely still using the highly flexible head, body and hands of a human. A recent example is human-machine interaction and augmented reality by craftsmen. Mitterberger et al. (2020) show an approach where an operator uses sensors connected to a computer, which later through a screen gives the bricklayer visual guidance on the right position of the brick. The two different examples show two different strategies to include the tacit knowledge and skills of craftsmen enabling complex geometrical assemblies.

2.2.5 Architecture as a workshop culture

The word *workshop* in a contemporary context usually has two meanings. It can be a craft or art workshop, or space or facility with tools and machinery to build larger or smaller objects. It can also be a large factory space. The second meaning is more of a gathering or meeting for a group activity, using a tool or method to explore, answer or discuss specific questions together, an activity for exchanging, sharing, or developing knowledge together. In architectural history, the first meaning and have been essential for craftsmen and craftswomen working together to pass on and learn a craft (Sennett 2008; Shelby 1972). The kind of temporary meetings can be connected to the conferences assembled to solve matters of importance in cathedrals' design and construction in Florence or Milan during the 14th and 15th century (Ackerman 1949; Heyman 1995; Prager and Scaglia 1970). However, group activities like this seem to go even further back in our history and may have been more critical in human evolution than one can imagine. Wilson (1998) describes the work by anthropologist Peter C. Reynolds, who suggest that the design and construction of specific advanced tools needed collaboration, and therefore means of communication. That the group activities has helped to develop languages and social cultures:

Reynolds suggests that complex tools, such as axes and knives, may in fact have been customarily manufactured by small groups of people working together, each performing some part of the task ... Any such cooperative efforts would have probably taken the form of hand signals and other bodily gestures or vocalisations, or both. In other words, cooperative tool manufacture could have provided a crucial precondition for the evolution of the language. An emerging language based in the growth of cooperative tool manufacture would have fostered the evolution not only of a more sophisticated tool manufacture but also a more complex social culture and a more refined language. (Wilson 1998 p.33)

Sennett (2008) describes and compares different types of workshop cultures during different times in history, such as from the medieval workshop, the Renaissance workshop and the violin maker Stradivarius. He defines a workshop as:

A more satisfying definition of the workshop is: a productive space in which people deal face-to-face with issues of authority. This austere definition focuses not only on who commands and who obeys in work but also on skills as a source of the legitimacy of command or the dignity of obedience. In a workshop, the skills of the master can earn him or her the right to command, and learning from and absorbing those skills can dignify the apprentice or journeyman's obedience. In principle. (Sennett 2008, p.54)

In this description, it possible to include a specialist group in a company or a research group, in which employees stay for a shorter or longer period to learn the skills from the group, the professor or the senior. This has been common in the history of the building, where journeymen travelled from different construction sites to learn from the master builder, maybe to one day become a master.

Addis (2007) writes about a studio workshop system when explaining the workshop culture in Italy during the Renaissance. Filippo Brunelleschi was one of the first develop, or graduate, from that workshop culture. Addis describes these studios more as an engineering apprenticeship than an artist studio. Brunelleschi, trained as a goldsmith learned to make clocks requiring complex mechanism as well as a deep understanding of the metals' material properties and how to manipulate and work with them. Addis describes how Brunelleschi developed a so-called 'engineer's eye' through his observations and practice within the workshop. He later used his trained eye for details as a master builder with great success, with the dome of Santa Maria del Fiore and Basilica di San Lorenzo.

In the culture of programming and code developing the workshop has two common forms — either the open-source coding or shared projects among friends and colleagues. There is also a shorter type of workshop referred to as a *hackathon*, to be described as a more experimental activity in order to test or develop new ideas. In architecture, there has been a merge of code developing and manufacturing. There are research cultures like the Block Research Group (BRG) at ETH Zurich, Centre for Information Technology and Architecture (CITA) at the Royal Danish Academy and Institute for Computational Design



Figure 2.27: *Smartgeometry at Chalmers University of Technology, 2016*



Figure 2.28: *Smartgeometry at Chalmers University of Technology, 2016*

and Construction (ICD), Institute of Building Structures and Structural Design (ITKE) and Institute for Lightweight Structures and Conceptual Design (ILEK) in Stuttgart, coming from Stuttgart culture of the Institute for Lightweight Structures (IL) founded

by Frei Otto. Other types of workshops are not tied to a specific university or company. One of them is *Smartgeometry*, a yearly organised symposium which contains a four-day workshop, similar to a hackathon, where researchers from both academy and companies participate. The workshop consists of several minor clusters examining different themes or questions related to architecture and technology. Researchers apply it to organise such clusters to try novel ideas or approaches with participants. There is a level of teaching and learning from each other when creating something together, potentially generating new research questions or insights (B. Peters and T. Peters 2013). Year 2016 Smartgeometry was organised at the Chalmers University of Technology, Figure 2.27 and 2.28, where the author was one of the local organisers (Smartgeometry n.d.). The author has used this type of experimental workshop that combines digital tools with manufacturing as a role model for teaching in collaboration with other researchers, artists, craftsmen and craftswoman, architects and engineers, Figures 2.29 and 2.30. These workshops have been documented and can be found at (Adiels n.d.a).



Figure 2.29: *Asymptotic grid shell under construction, built with students in the course Parametric Design - Digital Tools with bachelor students at the Architecture and Engineering program in 2019. The author was the part of the design team together with I. Näslund, J. Isaksson, H. Moubarak and C. J. K. Williams*



Figure 2.30: *Asymptotic grid shell as an exhibition space, built with students in the course Parametric Design - Digital Tools with bachelor students at the Architecture and Engineering program in 2019. The author was the part of the design team together with I. Näslund, J. Isaksson, H. Moubarak and C. J. K. Williams*

3 Art and Science - Research and design

Before discussing research methods and methodology, a general reflection on research, and especially the connection between art, or architecture, and traditional science will be made.

3.1 The blind scientist blowing bubbles

Here, for instance, we have a book, in two volumes, octavo, written by a distinguished man of science, and occupied for the most part with the theory and practice of bubble-blowing. Can the poetry of bubbles survive this? Will not the lovely visions which have floated before the eyes of untold generations collapse at the rude touch of science, and yield their place to cold material laws? (Maxwell 1874, p.119)



Figure 3.1: *Soap Bubbles* by Jean-Jacques de Boissieu

James Clerk Maxwell, a distinguished man of science himself, made this comment in his review of *Statique expérimentale et théorique des liquides soumis aux seules forces moléculaires* by the blind Belgian physicist *Joseph Plateau*. Most mathematicians know

the *Plateau problem* as finding a minimal surface based on a defined a boundary curve in space. It is possible to find the partial differential equation under which conditions a surface has a minimal surface area using the calculus of variation (Strauss 2008). Joseph-Louis Lagrange showed this already in 1762 (Hyde et al. 1997), the issue is to find a function $z = f(x, y)$ such that full-fills the requirement:

$$\left(1 + \frac{\partial^2 f}{\partial y^2}\right) \frac{\partial^2 f}{\partial x^2} - \frac{\partial f}{\partial x} \frac{\partial f}{\partial y} \frac{\partial^2 f}{\partial x \partial y} + \left(1 + \frac{\partial^2 f}{\partial x^2}\right) \frac{\partial^2 f}{\partial y^2} = 0 \quad (3.1)$$

Plateau proved in 1849 that the solution could be found experimentally using a soap-film spanning the void of a closed curve formed by a steel-wire. Plateau’s work has been important in understanding the forms of nature through physics and mathematics. Zoologist D’Arcy W. Thompson (1917) refereed to Plateau in *On growth and form*. Thompson believed that, in general, no organic forms existed that did not live in compliance with ordinary physical laws. Thompson’s work was influential to architect Frei Otto and structural engineer Edmund Happold in their pursuit of designing lightweight structures. (Walker and Addis 1997). However, is possible to perform research, or be inspired to derive questions from something as childish as blowing soap-bubbles? It seems that Platue is not unique in this sense. Platue includes a short review of previous scientific work using bubbles and soap films. According to Platue, Boyle was the first to to direct his attention to its properties followed by others such as Hooke and Newton, who described such experiments in his *Optics* (Plateau 1873/2005). Furthermore, Maxwell (1874) writes most poetically about the act of blowing soap bubbles and Plataue refers to the Etruscan children painted on a vase in the Louvre blowing bubbles. Plataue three times refers to “as children knows” and tells how the scientist Morey one evening was approach by a small girl who “showed him a similar perfectly regular line of from 22 to 23 small bubbles, having each one approximately a third of inch (8mm) length and a quarter of inch (6mm)” (Plateau 1873/2005, p. 260), almost as if they were talking about their own experiences. Similarly, Plateau describes his own fascination and the beauty of the experiments themselves

All these experiments are extremely curious; there is a particular charm to contemplate these thin shapes, almost reduced to mathematical surfaces, which are adorned with brilliant colours, and which, in spite of their extreme brittleness, persist for so a long time. (Plateau 1873/2005, p.83)

Before Maxwell (1874) goes into the review of Plataue work, Maxwell gives this quite interesting comment: “But we must now attempt to follow our author [Plataue] as he passes from phenomena to ideas, from experiment to theory” (p.119). Interestingly, Maxwell writes about the research process; from the phenomena or experiment to formulating questions and theories, which contrasts to traditional the scientific method, which is usually described the other way around. A more contemporary example working in such fashion described by Maxwell is the artist *Andy Goldsworthy*, Figure 3.2. Goldsworthy is an artist creating ephemeral sculptures using building blocks found in nature such as straws, icicles or stone rubble. An essential aspect of these sculptures is the interplay and interaction with the surrounding environment. In the documentary *Rivers and Tides*



Figure 3.2: *Sculpture by artist Andy Goldsworthy*

(Riedelsheimer 2001), Goldsworthy is observed creating these fragile sculptures in a tense atmosphere, where collapse is perilously close. Goldsworthy says

When I make a work I often take it to the very edge of its collapse, and that is a very beautiful balance. (57:00)

There are similarities to research in the sense of testing the limits of a material, or a design. To work with a defined method for each work but also focusing on specified phenomena to be examined. Goldsworthy concludes “The very thing that brings the work to life is the thing that will cause its death.” (10:30).

There has been quite an extensive debate regarding artistic research and its place in science. The same goes with architecture and design and their connection to engineering. One part of the debate is regarding the knowledge produced and how it is transmitted to other applications since most designs are unique and made for a specific setting or context. It might be worth summarising parts of that discussion in the next section.

3.2 Research in art and design

A suggestion for a research structure in the field of art and design has been given by Frayling (1993). This section will take departure in his article *Research in Art and Design* which is often cited by researchers in the field. Frayling (1993) describes three different categories of research in art and design:

1. Research into art and design
2. Research for art and design
3. Research through art and design

(1) *Research into art and design*, is the most straightforward, or uncomplicated, and includes historical research and various theoretical aspects of art and design. This is the most common category of research of the three.

(2) *Research for art and design* is probably the less clear one, or as Frayling states, research with a small 'r'. It is where the research is manifested within the artefact.

Research where the end product is an artefact - where the thinking is, so to speak, embodied in the artefact, where the goal is not primarily communicable knowledge in the sense of verbal communication, but in the sense of visual or iconic or imagistic communication. (Frayling 1993, p.5)

Frayling has a reference to an interview with Picasso in which the artist does not think his work is research. Frayling, however, opens for, or at least see a possibility, that it might be classified as research. What Picasso calls a gathering of reference material used to in his preparation might have similarities with research. Both Frayling and Arlander (2014) refers to the expressive art like dance and film for this type of research: "And yet many of the preparations for a production involve activities that are similar to research – such as archive research and experimentation. It is only a question of degree that separates them from more formal research processes." (Arlander 2014, p.33). Maybe it is possible to think of medieval or renaissance workshop or studio culture in which the research of the materials and the object itself closely integrated as described by Sennett (2008). In the field of architecture, it is possible to refer to Antoni Gaudí. Gaudí was commissioned to design the church in Colonia Güell 1898 and construction initiated in 1908, time which Gaudí should have used to inquire, research and develop the design (Tarrago 1985). The church in Colonia Güell never got finished and only the crypt exist. According to his associates, the church was a laboratory for his more known project, La Sagrada Familia, which is still under construction (Collins 1960). According to Collins (1960), Gaudí did

not leave any written material, and what is left are statements by his collaborator and others. Others have done articles to explain Gaudí's innovation, such as the architect Juan Rubio Bellver (1913) who worked with Gaudí and described the work at the Church at Colonia Güell. Most notably, in the church's design process, a hanging chain model was employed as a design tool. This is similar to a hanging chain, which in represents the form in pure tension in balance with the load, which inverted becomes a self supporting arch in compression. This was described already by Hooke in the 17th century and the hanging chain had been employed in the analysis of the Saint Peter's Basilica in Rome by Poleni (1748). However, Gaudí used it as a design tool in the design process and the model represented a much more complex three-dimensional network of forces. This is not easily transferred to a concrete design and there exist drawings in which they tried to visualise the building based on the model (Rubió i Bellver 1913). Today we usually refer to this as form finding, as described in section 2.1.4.

(3) *Research through art and design* is the second most common research category, even though not as frequent. He refers to three groups within this category: *materials research*, *development work* and *action research*. In the first group, Frayling refers to titanium sputtering and colourisation of metals and jewellery. Sputtering is a physical method in which energetic electrons are blasted onto a target surface to remove some of the metal atoms to compose a vapour. The vapour can then be applied as a thin film onto a substrate. The second group Frayling exemplifies as customising technology that enables some sort of novelty, where the results are communicated. The third group is related to the design process. The researcher documents her or his practical experiments performed in a studio or laboratory, and the resulting report contextualises it. In the paper *The Debate on Research in the Arts* Borgdorff (2007) elaborates on the categories by Frayling (1993) but instead use the terms in a modified manner (in the same order as Frayling): (a) research on the arts, (b) research for the arts and (c) research in the arts. In the last category (c) *research in the arts* Borgdorff refers to last category as the most controversial, and he adds a connection to Donald Schön's description of 'reflection in action'.

In the article '*In Nature's School: Faraday as an Experimentalist*' by D. Gooding (1985) on the famous scientist Michael Faraday it is possible to argue Faraday exhibited 'reflection in action'. As Gooding (1985) describes: "Faraday had the extraordinary ability to capture and hold this state of not being sure how to proceed. He used the ability to criticise his own experiments as well as those of others" (p.132). Frayling (1993) also has a hypothesis that the creative artist and the experimental scientist has much in common, mentioning the work of David Gooding, but also the book *Double Helix* by Dr James Watson:

Where the artist has difficulty persuading people of the connection of art with research, the scientist (whose research expertise has until recently been taken for granted) has exactly the same problem with creativity - which is generally seen as the prerogative of the artist rather than the scientist. This is partly why the process of discovering has been virtually ignored until recently, and why the activity of fine art is of increasing interest to historians of science. Look at *The Double Helix*: it could almost be an artist's autobiography. (Frayling 1993, p.3)

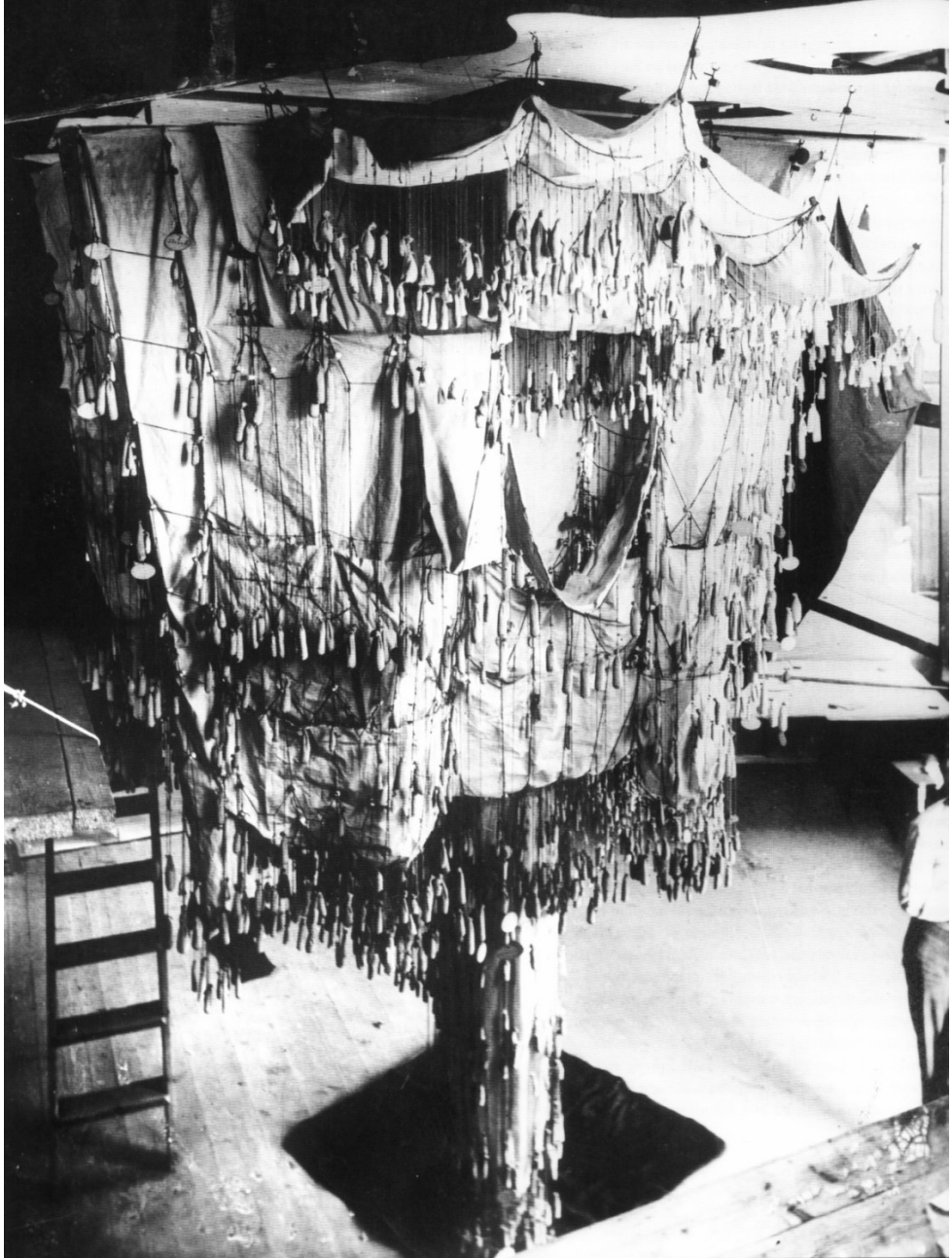


Figure 3.3: *Gaudí's hanging chain model used in the design of the Church at Colonia Güell*

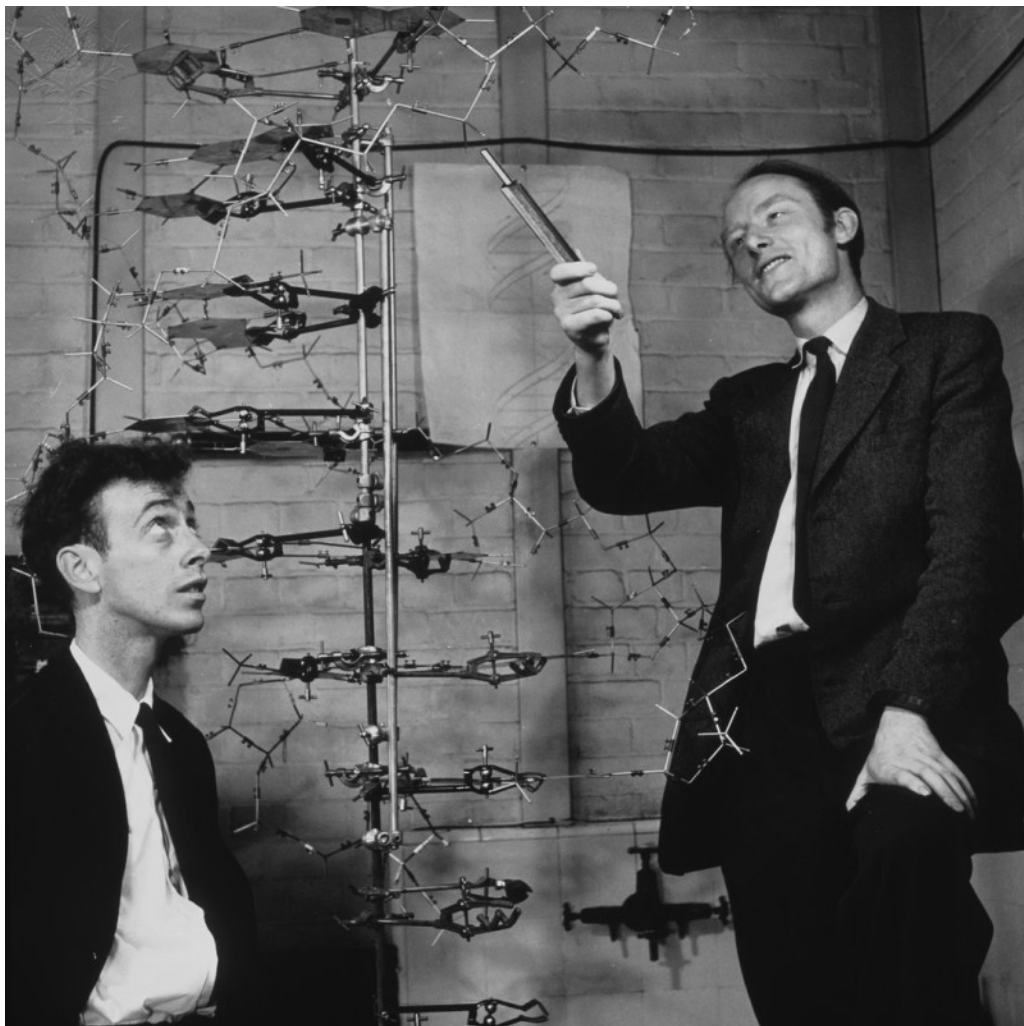


Figure 3.4: *Watson and Crick standing next to their model describing the helical structure of DNA*

The Double Helix is Watson's memoir on discovering the spiral structure of DNA, describing the work by him, Crick, Wilkins and Franklin. At the beginning of the book, Watson (1968/2010) states that research rarely is a linear process as outsiders often perceive it. Much of the progress is often based on human interactions in which personalities and cultural traditions are essential. The book illustrates a research process where theory development is closely integrated with performing experiments and building physical models, Figure 3.4. Similarly, Gooding (1985) highlights the importance of the experiments in Faraday's learning and understanding. Faraday seemed to learn a lot from his sketches, representations, and experiments that feed into his theories and results.

This can be compared to the iterative process described by architect Piano in section 2.2.3, sketches, drawings and models are developed to examine alternatives in order to find a well-elaborated proposal. Gooding is surprised that Faraday's learning process in this respect has not been further investigated earlier. According to Gooding, Faraday's most identifying skills was that he was good at learning how to do experiments. Faraday mastered this skill to such an extent, combined with transparency in his process, when demonstrating the phenomenon it fell out so naturally, nearly masking his involvement and the equipment's influence, almost as a magician as Gooding states.

Faraday's success as a discoverer and demonstrator reinforced confidence in the connection between doing experiments and learning about nature. He came to symbolise the educative possibilities of experiment and its role in building empirical foundations for scientific theory ... Many of those who have studied Faraday's experiments treat them as having identities fixed by their theoretical and pedagogical significance or by the technological implications of their outcomes. This has made Faraday's experiments appear, on the whole, less exploratory and adaptive and more theory-led than they usually were. (Gooding 1985, p.131)

Gooding (1985) ends his article by stating three stages in which Faraday's experiments evolve and develops. Where the experiment takes a different form depending on the intended knowledge extraction and information generation regarding the phenomenon, which relates to the timeline in his research process:

The first is the invention of strategies for discovery and the representation of new information. This takes place in the private context of the laboratory. The second stage is the development of strategies of proof or disproof, in which procedures, their rationales, and the interpretation of results are tried. Finally, the experiment is perfected as a demonstration, in which otherwise unobservable, recondite effects are made manifest to lay observers. (Gooding 1985, p.132)

Returning to the question on artistic research, is all art or design considered research? As both Frayling and Borgdorff state, everything that is art is not research. Borgdorff (2007) comes to this conclusion on when art practice becomes research:

Art practice qualifies as research if its purpose is to expand our knowledge and understanding by conducting an original investigation in and through art objects and creative processes. Art research begins by addressing questions that are pertinent in the research context and in the art world. Researchers employ experimental and hermeneutic methods that reveal and articulate the tacit knowledge that is situated and embodied in specific artworks and artistic processes. Research processes and outcomes are documented and disseminated in an appropriate manner to the research community and the wider public. (Borgdorff 2007, p.14)

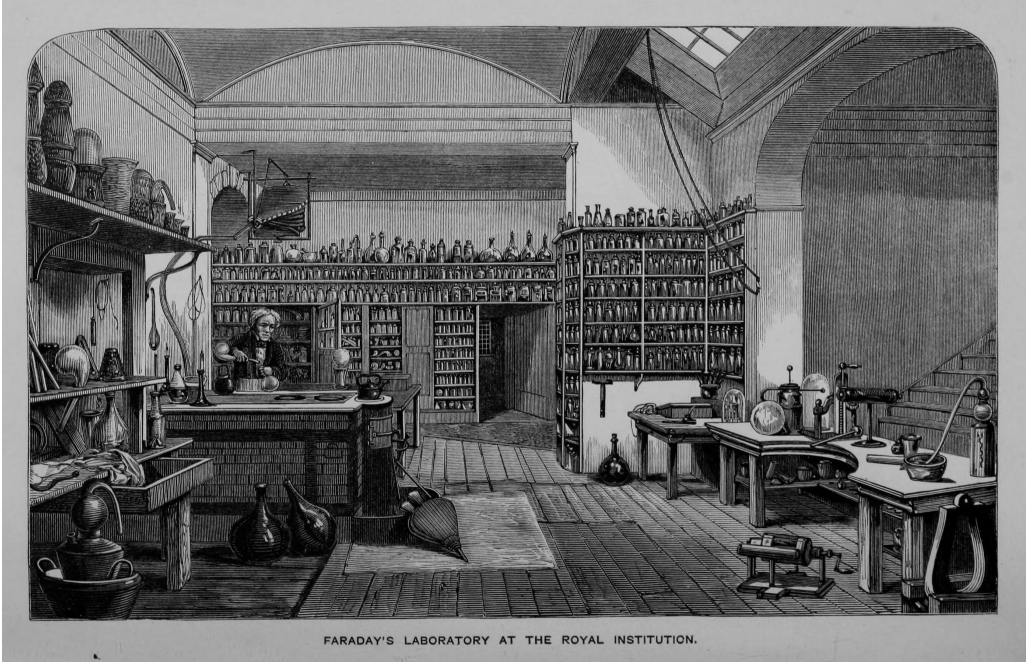


Figure 3.5: *Michael Faraday's laboratory (Jones 1870)*

An interesting aspect in Borgdorff's definition is that he states that the question is the starting point. However, reading about scientists like Faraday or Plateau there seem to be a more complicated connection between the research questions and the experiments, more of an interplay or connection where they develop together (Gooding 1985; Maxwell 1874). In comparison to Borgdorff, Arlander (2014) has an advice to the artistic researcher on three possible starting points: *the question, the method or the material*. Choosing one of them, gives freedom to work with the other two:

Attempting to formulate and fix all of them – question, method and material – in advance and keep to the research plan throughout the process is often pure idealism (and sometimes even damaging) in an artistic research process where every aspect can be in a state of flux. Most artists are able to embrace uncertainty in their creative process, and this could be an asset to fall back on. (Arlander 2014, p.39)

The uncertainty mentioned in the last sentence is similar to what Gooding describes on Faraday's ability to work in the unknown. Adding another layer to the proposals for a research structure in Frayling (1993) and Borgdorff (2007) is what in Hauberg (2011) refers to as *Research by design*. It has been used in the context of architectural research. It has some similarities to 'research through art and design' but more practised based and where the design and the research are further closely integrated. Furthermore, the knowledge generated while designing. Hauberg (2011) describes research by design as:

Research by design is any kind of inquiry in which design is a substantial part of the research process. In research by design, the architectural design process forms a pathway through which new insights, knowledge, practices and products come into being. Research by design generates critical inquiry through design work that may include realised projects, proposals, possible realities and alternatives. Research by design produces forms of output and discourse proper to disciplinary practice, verbal and non-verbal that make it discussable, accessible and useful to peers and others. Research by design is validated through peer review by panels of experts who collectively cover the range of disciplinary competencies addressed by the work. (p.51)

Continuing on the connection between 18th and 19th-century researchers and artistic research; a relevant historical example of what *research by design* could be is taken from the third Eddystone lighthouse outside Plymouth, designed and built in the middle of the 18th century. It was designed by the scientist and the so-called 'father of civil engineering' John Smeaton. From the beginning, Smeaton was an instrument maker and, like Faraday, skilled in making and preparing experiments (Smith 1981). He turned into engineering was one of the founders of the Society of Civil Engineers in 1771. The design process and construction of the lighthouse is well documented in his *A narrative of the building and description of the construction of the Eddystone Lighthouse...* (Smeaton 1791). Before Smeton's lighthouse, there had been two previous lighthouses on the same rock. The first lighthouse was built between 1696 and 1699 by Henry Winstanley was destroyed shortly thereafter in a storm in 1703, taking Winstanley with it. The second lighthouse built between 1706-1709 by John Rudyerd was more successful than its predecessor and stood for many years until it burned down in 1755. When given the commission of designing and building a new lighthouse, Smeaton managed to retrieve models and drawings from the previous designs (Mainstone 1981). The main structural system in both lighthouses was designed in timber, which had proven unsuitable in such harsh and moist conditions due to rot, worm attacks, and fire risk. Rudyerd's structure had circular or a cone shape built in a combination of wood and stone. Externally it had a skin of wood that would protect the inner structure. The bottom half of the structure was a mix of separate layers of solid oak logs, and Cornish Moorstone laid in succession. The hill had cut out in steps, and the structure was anchored with iron brackets in the bottom timber bed. Furthermore, in the centre, a wooden mast or pole was placed. Smeaton referred to it as a *piece of shipwright* (Smeaton 1791). Even though it was mainly in wood, the stone Smeaton believed was key to Rudyerd's lighthouse's long life. The stone's weight kept water from seeping in between the timber joints and keeping the structure from overturning by heavy waves; a similar principle found in Romanesque churches where the pure mass ensure stability. Therefore, along with the previous issues, Smeaton believed, that his lighthouse needed to be built entirely in stone.

Mr. Rudyerd was enabled to make a solid basement of what height he thought proper: but in addition to the above methods, he judiciously laid hold of the great principle of Engineery, that WEIGHT [*sic*] is the most naturally and effectually resisted by WEIGHT [*sic*]. (Smeaton 1791, sec. 40)

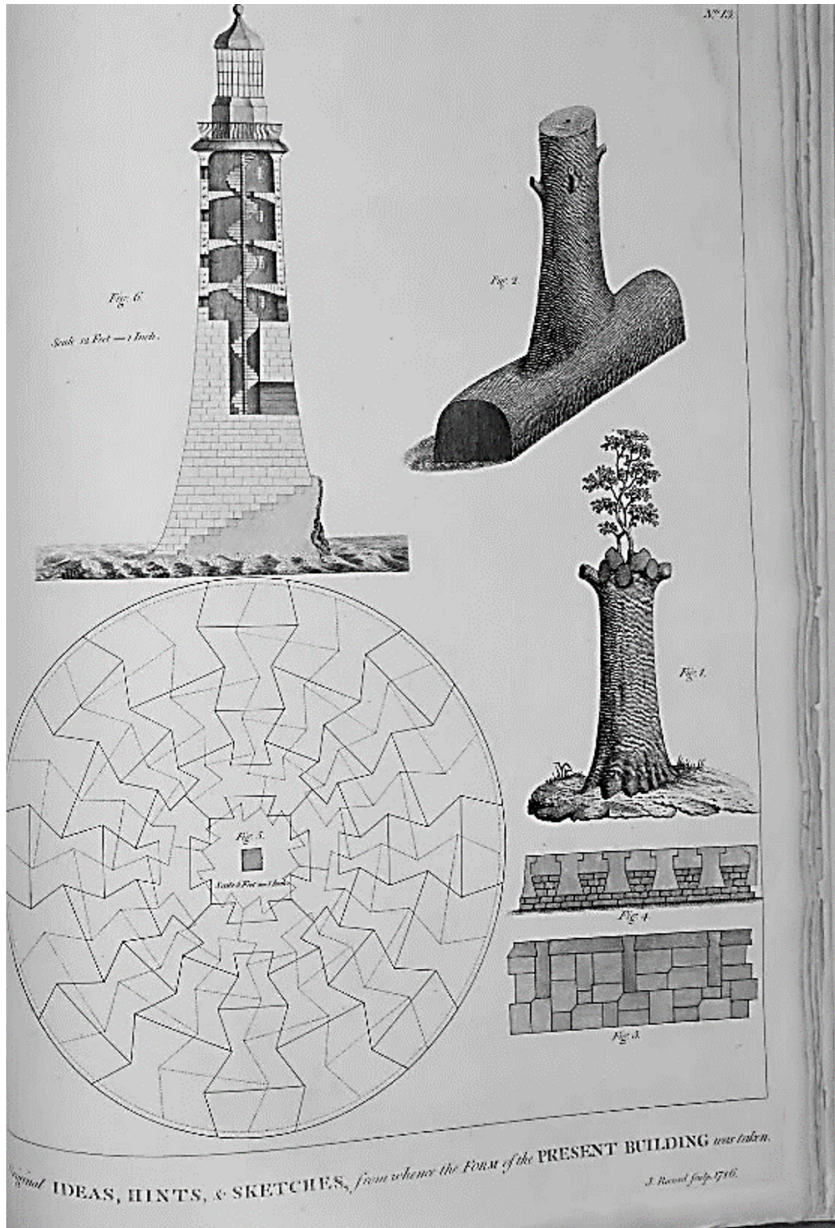


Figure 3.6: *Early sketches by Smeaton for the design of the third Eddystone lighthouse. Smeaton based the shape of his lighthouse based the idea of a tree and the novel masonry jigsaw puzzle based on the interlocking stone pavement in London and mentions in Belidor. (Smeaton 1791)*

However, this conclusion resulted in several problems that Smeaton was forced to address and handle. The most urgent issues were how to anchor the structure to the rocks and make the masonry tower stable during construction since lime mortar cannot settle in such moist conditions. Smeaton imagined a structure as 3d jigsaw puzzle using dovetailing, usually found in timber-work, based on a drawing found in Belidor's *Architecture hydraulique* (1737–53) and stone patterns in pavements in London (Smeaton 1791). It became too cumbersome to solve the vertical joints between the courses. Therefore, Smeaton only applied dovetailing within each course. Smeton instead used oak trenails and marble joggles in the form of cubes to connect two adjacent courses and avoid sliding between them. Smeaton read old manuscripts by both Alberti and Vitruvius to 'rediscover' the pozzolana, the volcanic stone, which added to non-hydraulic lime mortar, making it settle underwater. Smeaton has an entire chapter in his narrative called *Experiments on water cements* in which he formulates four questions:

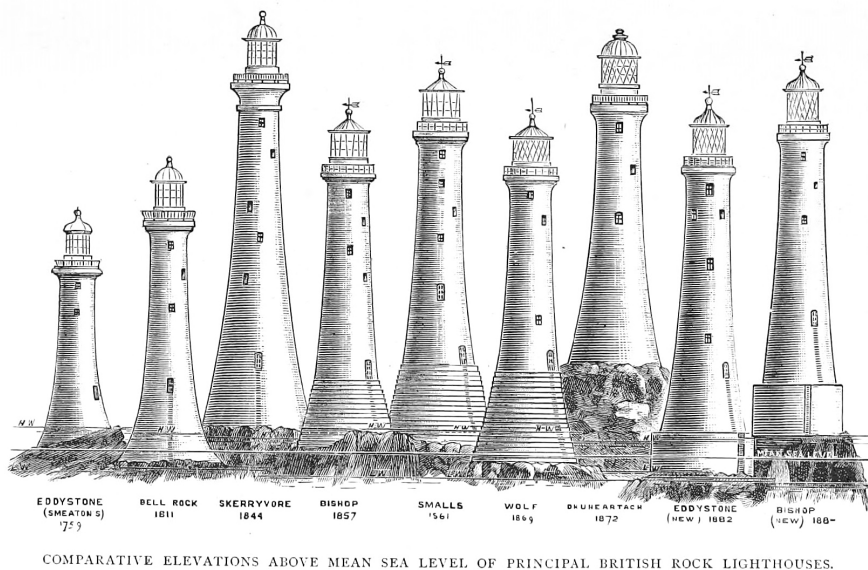
1. What difference in the effect results from lime burnt from stones of different quarries in point of hardness?
2. What difference results in the strength of the mortar when made up with fresh, or with Sea Water, the compositions being immersed in the same water?
3. What difference results from different qualities of limestone, so far as I could procure the specimens?
4. Whether Tarras Mortar, after having been once well beaten, becomes better by being repeatedly beaten over again?

It is in the third question of which Smeaton performed various experiments and discovers the natural hydraulic properties using limes from limestone with a significant quantity of clay. This is the beginning of modern concrete, and Smeaton's lighthouse design was copied or most influential for the coming lighthouses, Figure 3.7. Robert Stevenson (1824) writes with admiration of Smeaton and describes Smeaton's narrative as a kind of text-book for his design of Bell Rock's lighthouse.

Returning to Maxwell's review on the work on Plateau, he poses this question on the poetics of the boy blowing bubbles and the research trying to explain the phenomena:

Which, now, is the more poetical idea—the Etruscan boy blowing bubbles for himself, or the blind man of science teaching his friends how to blow them, and making out by a tedious process of question and answer the conditions of the forms and tints which he can never see? (Maxwell 1874, p.119)

Suppose the boy represents Goldsworthy and Plateau being the blind scientist. Maybe the distance between is not as big as we thought after-all, and the poetics might be as great.



To face page 24.

Figure 3.7: *Elevations and timeline of various British rock lighthouses, Smeaton's lighthouse left (Edwards 1884).*

3.3 Limitations and research methodology

Returning to the general questions in the introduction:

How can the current building culture be challenged by a reconsideration of historical and recent knowledge in geometry

1. How can the current building culture be challenged by a reconsideration of historical and recent knowledge in geometry?
2. How can the current building culture be challenged by a development of a digital craftsmanship for sustainable architectural design and production?

The questions were contextualised in chapter 2. In section 2.1 the influence of geometry in architecture, structural engineering, and construction through the history was shown. An overview of the development of knowledge in geometry was also given. Section 2.2 highlighted the urgent challenges for a sustainable building culture, how the international society express these challenges, and how an expanded craftsmanship culture in a digital context could serve as a tool. Characteristics like the close hand and head relationship, the personal control and responsibility for the process, and the proudness of what has been achieved, was discussed. Two different approaches were presented of how to combine traditional craftsmanship with digital craftsmanship and technology; either using advanced digital manufacturing machines or using technology to assist and aid the work

of craftsmen and craftswomen.

Timber and bricks are the materials that has been chosen as a focus. In the history of architecture and construction, they are the two most classical buildings materials. They are also relatively easy to process or modify using simple tools. Bricks are designed in size and weight for the hand while similarly timber can be made in various sizes. Timber is accessible in regions like North Europe and North America (Forest Europe 2015; Pryce 2005). At the same time, bricks have and can be made in almost all regions of the world in different forms (Campbell 2003). For instance, in Sweden, there existed 500 hundred brickyards at the beginning of the 20th century (L.-E. Olsson 1987). The historic references and long time experience of the two materials as well as the local accessibility of at least one on them almost worldwide, make them to a suitable choice of materials for the investigations in this thesis.

Research methods was chosen from the traditional scientific approach as well as from the artistic research process described in 3.2. A literature review was performed in both historical and contemporary architecture and mathematics as well as theory in geometry and its connection to physical phenomena related to architectural design. Theory development was used as a qualitative approach described in (Hammond and Wellington 2021) for exploring, explaining, and uncovering phenomenon; and generating new theoretical insights in geometry in connection to architecture. The theory was evaluated by performing numerical simulations and digital experiments through programming computer programs or scripts linked to architects and engineers' digital toolbox and digital environments, such as *Rhinoceros3D* and *Grasshopper3d*. Design inquires, or design challenges were used to arrange experiments around research questions and generate new research questions — the type of action research described in the category of Research through art and design by Borgdorff (2007). The design and applications were intended for the conceptual and early-stage design process and physical prototypes in controlled environments. Film and moving pictures were employed to document the process and its associated experiments. There is also a second aspect of capturing and making movies. It was used as a forum or tool to discuss new insights or aspects in these buildings and experiments with others. It could be the architectural qualities, theories from craftsmen how things were made, mechanical phenomena in the models or possible methods to analyse the behaviour.

In the following sections, the research questions are redefined to a more detailed inquiry as well as how the research methods have been applied to answer the research questions. Since the two categories of research questions differ in research methodology, they are described separately.

3.3.1 Research question 1

The first of the general research questions will be further condensed into two more specific questions:

1. How can the current building culture be challenged by a reconsideration of historical and recent knowledge in geometry?

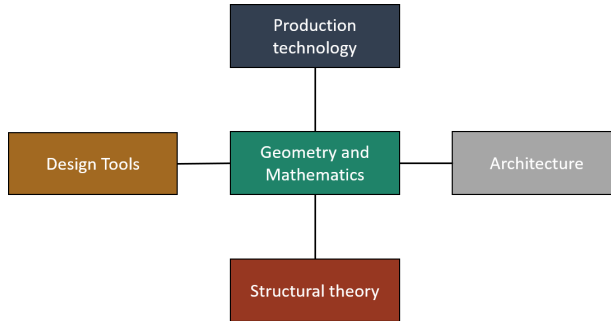


Figure 3.8: *The literature review was emphasised how geometry and mathematics have been linked to applications in architecture and structural engineering in the categories: design tools, structural theory, production technology and architecture (space).*

- i How can we use differential geometry design structural forms and patterns that consist of simple building elements. More specifically, how can we apply brick patterns on shells and vaults?
- ii Is there a way to describe a shape of a shell, or family of surfaces/certain properties of surfaces, that balance aesthetics, structural performance and buildability? Surfaces of constant have several advantages, particularly in controlling the ratio of rise to span of surfaces with varying span. More specifically, is it possible to apply Biot-Savart law from potential theory to generate surfaces of constant solid angle?

Question 1.i is investigated in paper A, and research question 1.ii is investigated in paper D, and the following explains the research methodology used to find and later answer these specific questions.

The literature review was conducted through a historical overview through two aspects:

1. The development of geometry as a mathematical field and the influence of geometry for developments in physics.
2. The relation of geometry in the architectural design and construction in history until today.

The first type of literature review was performed by studying early developments in geometry in Egypt and Greece until the developments of differential geometry. The most literature studies in mathematical theory were in differential geometry from Gauss to the geometry used by Einstein in the theory of relativity. The literature have been chosen based on classical and established books and authors in the field of mathematics such as Struik (1988), Stoker (1969), Pressley (2009) and Carmo (1976). For the between geometry and to continuum mechanics mechanical engineering the works of Green and Zerna (1968), as well as Timoshenko (1934; 1959).

The second aspect is the application of geometry in design tools, structural assessment, production technology and architecture (space), see figure 3.8. The scope was limited

through a choice of various examples to be reviewed based on the previous parameters. The examples are mainly in the field of masonry and brick shells and timber gridshells. They were chosen based on the relevance for the research questions as well as impact, novelty or influence in the development of architecture, structural engineering and construction, see figure 3.9. To get an overview of the development the various examples were put into a matrix with the different categories, similar to Addis (2007), Figure 3.10 shows an example of Eddystone lighthouse.

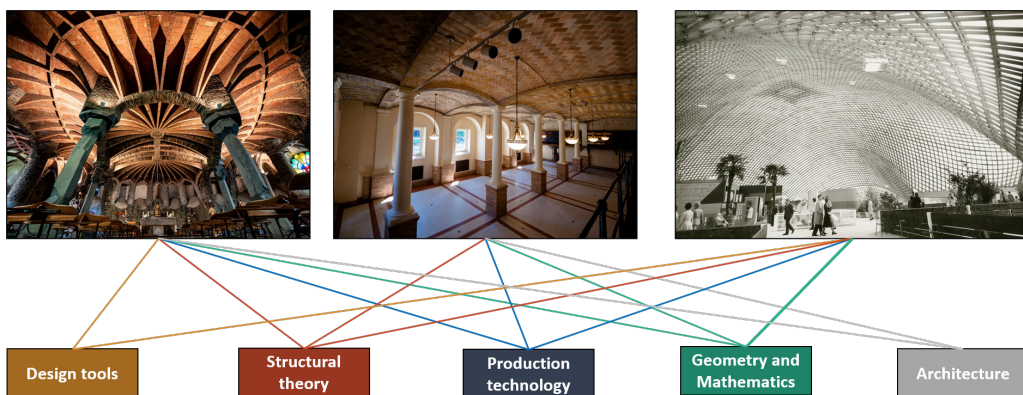


Figure 3.9: In the literature review, various built examples were examined using the the various parameters.

The literature review over architectural examples as well as the review of theory in differential geometry and physics was used in the theory development. It explored the historical material, the written records or tacit knowledge embodied in drawings or the built examples. The literature review over the theory in differential geometry was used to develop the theory to form new insights of historic structures as well as in the design of new structures. The simulation involves numerical methods to solve partial differential equations as well as geometrical programming packages such as *Rhinocommon* in the commercial software *Rhinoceros3d*. The evaluation of the simulation is done by performing digital experiments generating various digital models and comparing it to the theory through the digital model’s geometrical properties and measurements. This research methodology used in paper A is described through Figure 3.11.

3.3.2 Research question 2

2. How can the current building culture be challenged by a development of a digital craftsmanship for sustainable architectural design and production?
 - i How can digital craftsmanship incorporate material and geometrical constraints, local skills and available technologies in the design and construction process? More specifically, how can digital craftsmanship and physical prototypes in the design of an exhibition space be built of flat planar laths in just two days







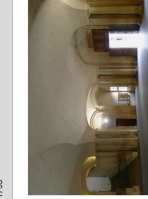

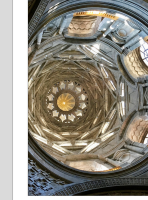

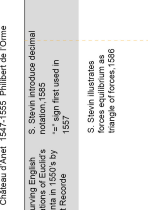
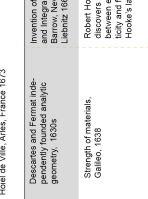
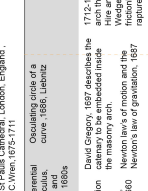
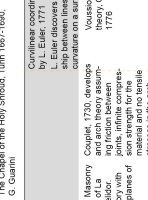
	1550-1600	1600-1650	1700-1750	1750 - 1810	
Geometry and Mathematics	 <p>First surviving English book on statics Elements in 1504 by Robert Recorde</p> <p>S. Stevin introduces decimal "sign" first used in 1557</p> <p>S. Stevin illustrates force equilibrium as triangle of forces, 1586</p> <p>Château d'Anet 1547-1555 Philibert de l'Orme</p>	 <p>Discusses and Fermat introduces analytic geometry, 1630s</p> <p>Strength of materials, Galileo, 1638</p> <p>Hôtel de Ville, Paris, France 1673</p>	 <p>Calculating circle of a curve, 1650, Leibniz</p> <p>St Paul's Cathedral, London, England, c. 1675-1711</p> <p>David Gregory, 1697 describes the catenary to be embedded inside the masonry arch</p> <p>Robert Hooke discovers relation between force and force, Hooke's law, 1660</p> <p>Newton's law of gravitation, 1687</p> <p>Hooke identifies the relationship between the hanging chain and the inverted arch in compression, 1675</p>	 <p>Conformal coordinates used by L. Euler discovers the relationship between lines of principal stress and principal strain, 1776</p> <p>Vossler's station theory, 1776</p> <p>Coulpet, 1730, develops and arch theory assumption of the weight theory with frictionless planes of action strength for the arch</p> <p>1712-1725 Masonry and arch theory assumption of the weight theory with frictionless planes of action strength for the arch</p>	 <p>Bell Rock Lighthouse, Angus, Scotland, 1807 - 1810.</p> <p>Stirling's Lighthouse at Eddystone rocks 1756-1759</p> <p>Ruysdael's Lighthouse at Eddystone rocks, 1720-1725</p> <p>Winstanley's lighthouse at Eddystone rocks, 1696</p> <p>Great Fire of London, 1666</p> <p>Winstanley's lighthouse at Eddystone rocks, 1696</p> <p>Winstanley's lighthouse at Eddystone rocks, 1696</p>
Structural theory					
Production technology					
Material development	 <p>Theodotus first mentioned by Leonard Digges, 1611</p>				
Design tools	 <p>The unpublished manuscript of Rodrigo Gil de Hontañón gives different geometrical and arithmetic rules to design different structural elements, c. 1550.</p>				
Architecture					
Buildings	 <p>Château d'Anet 1547-1555 Philibert de l'Orme</p>	 <p>Hôtel de Ville, Paris, France 1673</p> <p>St Paul's Cathedral, London, 1667-1690, G. Guarini</p> <p>The Chapel of the Holy Shroud, Turin 1697-1890, G. Guarini</p>	 <p>Eddystone Lighthouse, 1756-1759</p> <p>Bell Rock Lighthouse, Angus, Scotland, 1807 - 1810.</p>		
Books and literature	 <p>Le Premier Tome de l'architectonique de Philibert de l'Orme, 1587</p> <p>Manuscript of Rodrigo Gil de Hontañón, c. 1550</p> <p>De Roboribus et Hydrostaticis, 1587</p> <p>A geometrical treatise named partimento, Leonard Digges, 1571</p>	 <p>Dialogue concerning two new sciences, 1638, René Descartes, La Gemmeille, 1637</p> <p>Philosophie naturelle Principes de Mathématique, 1687</p> <p>Statique, 1686, S. Stevin</p> <p>Geometrical treatise named partimento, Leonard Digges, 1571</p>	 <p>Traité de mécanique, P. Varignon, 1715</p> <p>La Théorie Et la Pratique de la Construction des Machines, 1729</p> <p>Cours des P.A. Fresner, 1727-29</p> <p>Winstanley's lighthouse at Eddystone rocks, 1696</p>	 <p>The Principles of Mechanics, William Emerson, 1758</p> <p>Recherches sur la courbure des surfaces, 1760, L. Euler</p> <p>Ruysdael's lighthouse at Eddystone rocks, 1720-1725</p>	
Events					

Figure 3.10: A matrix has been used in literature review of the development in architecture and mathematics through history, based on a set of parameters. This particular matrix is connected to the developments in connection to the Eddystone lighthouse by Smeaton

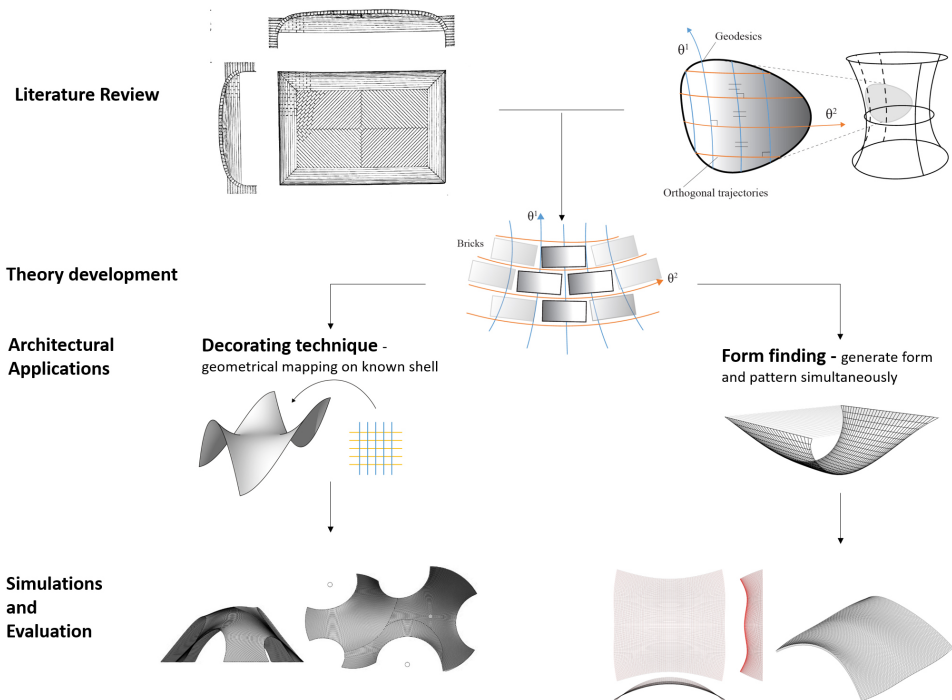


Figure 3.11: *Conceptual image of the methodology used in paper A and paper D. At the top shows the literature review in both field of architecture and the field of mathematics and geometry. The theoretical framework in geometry is developed to explain or create new insights of these historic structures with the possibility to apply it in contemporary projects. The last step is to evaluate the theory and the possibility to use in the architectural design process.*

with a group of students? More specifically, how can digital craftsmanship be developed to enable the design of an exhibition space to be built of flat planar timber laths in just two days with a group of students?

This research question is connected to paper B and C. These papers reports and reflect upon the design and construction of two indoor pavilions.

The specific research question was formulated almost as a challenge where the constraints and limitations defined from the beginning were used as method to make choices in the design process and force new ideas that can be developed. There is an unknown parameter using a group, in this case, bachelor level students in architecture and engineering, where the skills and experience in building and construction vary in the group. This level of uncertainty, or lack of precision compared to perfectly crafted elements and operations, directly relates to choosing resolutions and exactness in the structural analysis and the detailing. The literature review was based on historical and contemporary references from structures as well as research pavilions with similar challenges or geometrical constraints. Literature in differential geometry was revived to find geometrical concepts that work

with flat planar objects and the theoretical constraints or freedoms in the form. From a range of theoretically viable concepts, a rough evaluation was done to narrow the selection. The evaluation was based on time and feasibility to construct the elements, economy, utilising the group most efficiently, safety, time and feasibility to assemble and erect the structure.

These criteria were applied in an iterative circular design process where digital drawings and models, were tested against smaller and larger physical models, and material parameters. Similar to the design method described by Piano in section 2.2.3. Moving pictures was used to document manufacturing (time to build) as well to capture the phenomena occurring during model tests. This was an iterative process where model tests and manufacturing methods informed and challenged the digital design. A proposal was made with a set of manufacturing tools or technologies associated with the construction from the iterative design process. From that point, the digital craft took place to prepare and generate all the necessary production drawings and production data to communicate with the fabrication process with the persons and machines during the experiment.

During two days, the experiment was conducted. Before the experiment, the participants had been informed about the design process, the mathematics behind the concept, and the shared open-source code. The group were presented to various tasks associated with the production drawings and were free to form smaller units. Each unit was responsible for structuring their working process and deciding how to use assigned manufacturing tools, but with the design team's help. After the structures were manufactured, assembled and erected and the exhibition was over the experiment was evaluated through a qualitative assessment based on questions such as: was the structure built on time, did everything fit together, how was the coordination among the group, could the instruction been better, how did the details look, did any elements break during construction? The structure was later used a big test model where the structural analysis and behaviour hypothesis was tested by loading and pushing the structure. Rough measurements were done to check the resemblance with the digital model or expected difference. An open seminar was arranged before the structure was taken down. Students, researchers and professionals were invited to a discussion where participants were allowed to give their opinion regarding improvements, new research questions and new insights.

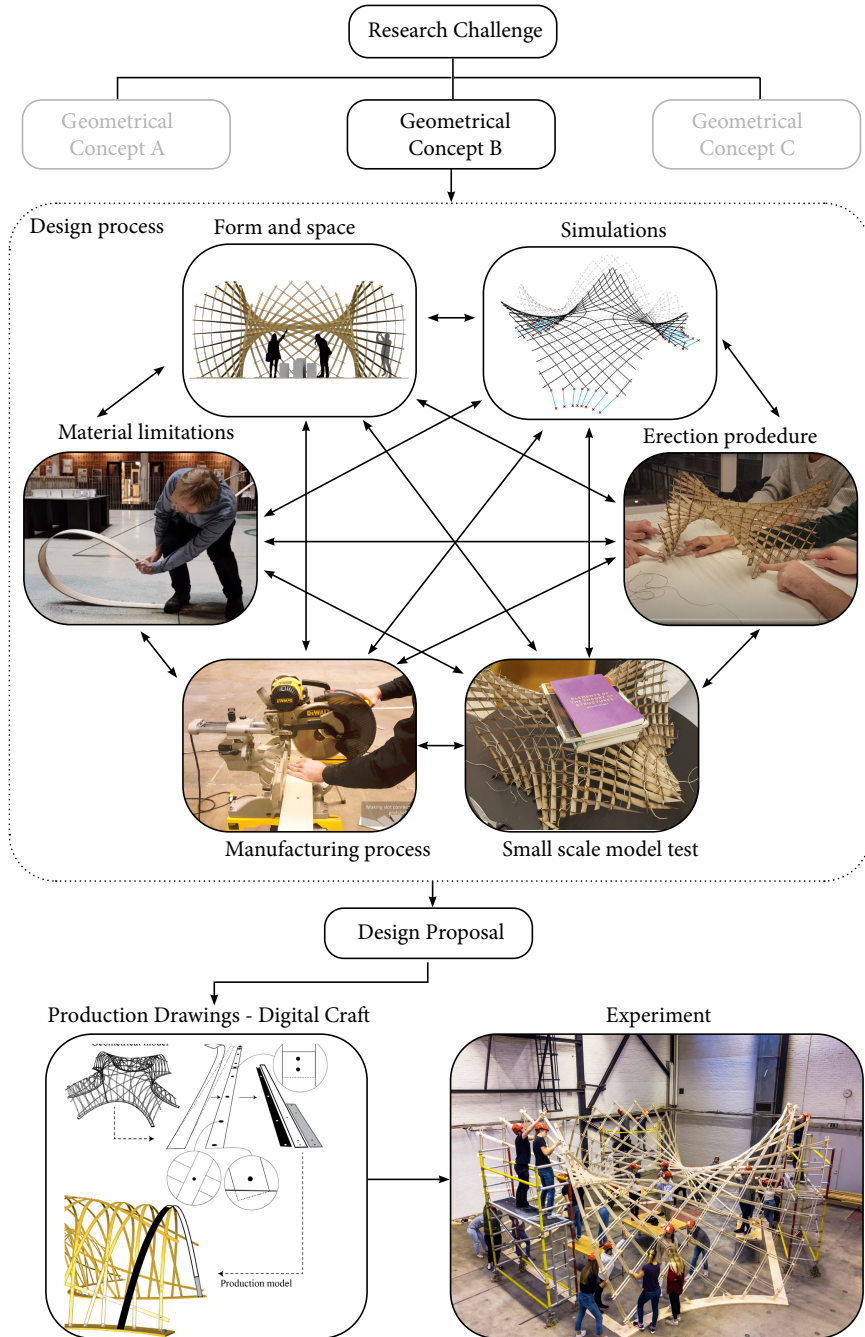


Figure 3.12: *Conceptual image of the methodology in question 2*

4 Summary of papers and other important works

4.1 Paper A

Brick patterns on shells using geodesic coordinates

The first paper present two separate strategies for generating brick patterns on free form shells and vaults using geodesic coordinates. The brickwork is specified by a surface on which there is a geodesic coordinate system satisfying the condition for a constant distance between bed joints. The first strategy integrates the generation of the geodesic coordinates in a form finding procedure derived from the geometrical and mechanical properties of a shell. The geometric and structural equations are solved using dynamic relaxation. The second strategy can be applied on an arbitrary surface separating the form finding and brick pattern generation enabling adaption to different constraints in the design process.

Contributions by Emil Adiels

Emil Adiels, was the primary writer of this paper and developed the code, implemented the method and generated the results of the second strategy in the paper. The idea was developed by Chris Williams, Emil Adiels during his master thesis. This paper extends from those investigations but with further developed numerical methods. The paper was presented by Emil Adiels at the IASS 2017 symposium in Hamburg.

4.2 Paper B

Design , fabrication and assembly of a geodesic gridshell in a student workshop

The second paper describes the design, fabrication and assembly of an 11x11m gridshell built of plywood laths during a two and a half day workshop in a new undergraduate course about parametric design and digital fabrication. The question was how to use full-scale prototyping to summarize and integrate the learning outcomes in this course. The design was incorporated in a full parametric model including automated design checks and the generation of all necessary production.

Contributions by Emil Adiels

Emil Adiels, was the primary writer of this paper and presented the paper at the IASS 2018 symposium at MIT in Boston. The preparation of the experiment including the design, building models and prototypes, acquiring materials and tools, writing code, informing the participants and generating production drawings was performed by Emil Adiels together with the other authors.

4.3 Paper C

The design , fabrication and assembly of an asymptotic timber gridshell

The third paper describes and discuss the design, fabrication and assembly of an asymptotic gridshell built of plywood laths. The overall question concerns how geometry, structural action, and efficient production can interplay and inform spatial design. The experiment was conducted during a two-day workshop where architects, engineers and researchers with specialization in structural and digital design cooperate with undergraduate students in a compulsory parametric design and digital fabrication course. The gridshell shape was based on an Enneper surface of threefold rotational symmetry with a boundary baseplate inscribed within a circle of 4.5m radius. Utilizing the concept of asymptotic curves, which are surface curves whose osculating plane coincides with the tangent plane of the surface, the structure was built using planar straight laths of plywood made using manually operated drills and saws.

Contributions by Emil Adiels

Emil Adiels, was the primary writer of this paper and presented the paper at the IASS 2019 symposium in Barcelona. The preparation of the experiment including the design, building models and prototypes, acquiring materials and tools, writing code, informing the participants and generating production drawings was performed by Emil Adiels together with the other authors.

4.4 Paper D

Surfaces defined by the points at which a closed curve subtends a constant solid angle

The fourth paper examines an appropriate form for a shell, that can balance aesthetics, structural performance and build-ability, with a proposal for the use of surfaces with constant solid angle. The paper describes a method to generate such surface by applying the Biot-Savart law, which describes the electromagnetic field caused by constant electric current in wires. The surface was generated with a Delaunay triangulation. Thus, future studies would include incorporation of other types of patterns facilitating buildability.

Contributions by Emil Adiels

Emil Adiels was part dialogue and discussion which developed the idea and theory behind the paper with Chris Williams. Chris Williams together with Emil Adiels wrote the paper.

4.5 Publication I

The historical and technological development of masonry structures

This work aims to study technical development masonry and brickwork structures in relation to architecture. Due to its durability, masonry buildings can remain for several hundred and sometimes over a thousand years. Therefore, a considerable part of the historic buildings and important cultural buildings that still exist are of masonry. Thus, masonry structures have much cultural value, but can also due to long life span be important for sustainable construction in the future. The method is based on selecting built examples and parameters related to the knowledge and tools at the time of design and construction. The chosen parameters are used to evaluate the current ability and idioms regarding *geometry and mathematics, structural theory, design tools, production methods, material development, and architecture*. This work is centred around five examples from different periods: the cathedral of Saint-Denis, the dome of Santa Maria del Fiore, the third lighthouse of Eddystone by John Smeaton, the Boston public library and the unfinished crypt in Colonia Güell by Antoni Gaudí. Each example is placed within its historical context and evaluated based on the chosen parameters.

This work is expected to be published in 2021 and has been funded by ARQ, a research foundation by White architects, www.arqforsk.se

Contributions by Emil Adiels

Emil Adiels is the main writer of this work.

4.6 Publication II

The composition of matter, space, time and structure in masonry and concrete vaults

Between 2018 and 2019 a series of buildings was captured in motion pictures. The buildings are mainly shells structures of masonry, brick or concrete. The structural benefits of vaults and domes are well known. However, they also possess unique architectural and spatial qualities. They are often a result of an architectural aspiration idea that, in the best examples, exist in an interplay with the load-bearing structure. The difficulty is communicating the architectural aspiration and the qualities, such as materiality, spaciousness and light to someone who has not or ever will experience it. Traditionally it is done through text and pictures, but is it the best way? It led to the research question of *how to communicate the spatial experience and spatial qualities of these spaces?* An experience that is both personal and subjective, so the challenge is to portray that feeling embodied in the architecture. The chosen method of answering this question was using motion pictures accompanied by music. During trips around the world, chosen objects were filmed and later edited with added music. At the moment of writing, the result is ten movies of ten different buildings, which are 1.5 - 3 minutes in length. The movies

were aired and presented during the Advances in architectural conference in 2018, and are available at (Adiels 2020). An interview was made in relation and concerning the work and purpose and can be found at (Adriaenssens 2019).

Contributions by Emil Adiels

Emil Adiels prepared the shooting of the films including trips, equipment. The movies were made by Emil Adiels including the shooting, editing and distribution.

5 Discussion

This section will reflect upon the results and insights provided in the thesis. I will also address the contribution concerning the challenges regarding sustainability and possible directions for future work.

5.1 Research questions and results

The first question was: *how can the current building culture be challenged by a reconsideration of historical and recent knowledge in geometry?*

Two studies have been performed that is more theoretical are presented in paper A, and paper D. Two experiments have been performed in paper B and C which both utilised simple building elements as a restriction in the design.

Paper A suggested the application of geodesic coordinates to describe the bed joints described in drawings of shells, and how it can be implemented in new designs of shells. In my opinion, it gives a better understanding of the embodied knowledge of how craftsman and craftswoman envisions the design, without necessarily automating their work. The methods presented can be used to design new structures as well as understand existing ones. In a design process, they could enable a dialogue between an architect and a craftsman where both aesthetics, structural performance and construction are inter-playing. A reasonable criticism is that we have interpreted drawings. Thus, future studies could involve the feedback from craftsmen and craftswomen. The presented strategies can, however, be applied to more than brick patterns. Recent papers by (Motamedi et al. 2020) and (Carneau et al. 2019) have applied it in the context of 3d printing. So there might be other technologies and new applications of this in the future.

Paper D shows that surfaces of constant solid angle as a possible compromise between aesthetics, structural performance and buildability. It might be a new type of surface, but it can very well exist under a different name in different fields. Thus, the paper highlights one of the challenges with shells structures in coping with complex geometrical boundary conditions. There is a possibility in further studies to describe how more elaborate geometrical patterns can be applied that facilitate the construction and manufacturing. While paper A and paper D are more theoretical and simulated using digital models, Paper B and Paper C were intended to explore how it can be applied early in a design process, from design to manufacture. In those two papers, we had to use the regular 6mm birch plywood boards cut into straight laths to use the boards most efficiently and reduce waste. The pavilions show how geometry can still enable elaborate designs even with limitations regarding the building elements when practised early in the process.

The second question was: *how can the current building culture be challenged by developing digital craftsmanship for sustainable architectural design and production?*

Two design inquiries and experiments were arranged and executed to investigate how digital tools can be applied in a design and construction process using simple building

elements and simple tools presented in paper B and paper C. Those experiments were temporary, smaller in scale than projects in industry, and they were performed under particular conditions. Still, some conclusions can be made regarding how digital craft can assist in navigating, managing and utilising the constraints and the limitations related to an architectural context during a design and construction process.

Sennett (2008) describes craftsmen and craftswomen who work *with the resistance* rather than against it. Similarly, before construction, a significant part of the investigations was to understand the context and the limitations and use it as an instrument for decisions in the design process. The success was that we worked with many parameters simultaneously in the early phase of the design process and continuously tested it against the limitations and constraints. We alternated between digital models and physical models during this process, extracting information of one to inform the other. Similar to the process described by Renzo Piano in section 2.2.3. In our case, the parameters were the form and space, the pattern, the analysis, and the manufacturing. As philosopher Bornemark (2018) describes, parameters are often linked in an intricate weave difficult to measure isolated from the others. Hedenus et al. (2018) use the word *systems thinking* to describe working with many interconnected parameters. During this process we also tested our ideas against craftsmen and craftswomen at the university, and got help to improve the manufacturing process.

Another important aspect was to choose the proper *resolution* in the different stages in the design process. It refers to the resolution or level of detail in the digital modelling, calculations and physical models. In the beginning, we worked with rough conceptual digital models to build rough physical models to save time. Before performing structural analysis, we asked ourselves what we wanted to know and how accurate it based on the execution and tolerances. Often it was the simple test with the actual materials and the small scale models that made us confident to proceed in a specific path. Some might find it funny, or even unserious seeing engineers bend and twist plywood laths. Nevertheless, these tests were probably more accurate in this case since the processing of elements was likely to vary during the experiment. For instance, a drilled hole could get closer to the edge than we would like. That uncertainty or tolerance in the production has to go into the structural analysis, and a FEM analysis might do more harm than good. I am not saying that bending the elements is always applicable. However, it is sometimes worth asking how accurate the numerical analysis is, it is easy to be tricked by pretty colours or point at an analysis done in a computer as a truth. Sometimes, a simple physical model says more than a thousand digital interpretations or computer analyses. This was especially true when it came to understand the kinematics during erection, which we found challenging to simulate properly. There is a potential danger in distancing from the physical world working only with digital models and computer analysis. Similarly, Wilson (1998) describes the importance of kids playing outdoors, throwing real baseballs rather than virtual ones to understand the world better. Some aspects of that is also true for structural engineers. Still, we performed FEM analyses of the entire system to check against the material test and the smaller models' behaviour. The analysis gave a rough estimate of the deflection, giving people enough height to stand. It was tradeoff since we needed to limit material and the height to work more safely from the ground. One of the project's criticisms could be that it is hard to perform exact measurements of the

transition from the digital model to the physical model. It became more of an overall assessment. In this case, with so many limitations in time and built by students, it was not easy to be more accurate, and it was not the primary investigation.

Another critical aspect of the digital craft was to *simulate* the production process in advance before the construction and manufacturing phase. It made it possible to swiftly see errors in the design and the computer code, potential difficulties during manufacturing and erection and estimate the material costs, during design changes. *Symmetry* and *repetition* were two characteristics in the design we noticed limited material, the number of drawings and confusion on site, which was vital to facilitate swift production from plywood boards to finished construction in just two days. Time is an essential factor, and in that regard, these experiments are similar to what is critical in a real project. It also was vital to add *flexibility*. Meaning that some things will likely go wrong, and during the experiments it was crucial to handle that on-site. We had elements that broke, but since we made everything on-site, it was a just a ten-minute delay to create a new one. If we had prefabricated everything, it would potentially be a costly delay in both time and money, which we could not afford. In all the manufacturing processes, we had a strategy associated with the production drawings and data. However, the group responsible for the specific task could modify it or choose a different method for solving the task. In the end, they had much better knowledge of how to do it most efficiently. In other words, we applied a strategy of giving enough instructions, in terms of drawings and digital models, to apply their judgement. According to Bornemark (2018), who studied the healthcare system, processes or instructions purely designed to leave out professionals' good judgment often satisfies the lowest quality level. Similarly, it is worth to invest in people, incorporate their professional judgement, and give the craftswoman or the craftsman, whether it is a nurse, a teacher or a carpenter, enough structure and resources to apply their skills. Mattias Tesfaye (2013), a bricklayer, describes craftsmanship and quality work as an expression of people living in freedom holding a responsibility to the community. In our case, we gave our students the freedom to choose their solution; similarly, it comes with a contract to their classmates to do their best to reach the common goal. We very much encouraged our students to take initiatives. A key aspect of our workshop was to find that balance in the digital craft. It was essential to motivate people to make them feel responsible and committed. One of our biggest fears was that they would not feel part of the project since they were not involved during the design process, similar to the Lalibela roof structures. However, in the end, it was not the design teams project; it was collective ownership with everyone involved; that was my feeling. The computer code behind the project which was distributed was written in an environment they mastered, possibly adding to the sense of shared ownership. However, many students who evaluated the course, which the workshop was part of, were positive regarding the workshop. Even though delegating responsibilities during the experiment was mainly successful, we in the design team were those with the most complete holistic view of how all pieces fitted together and thus the final *responsibility*. Thus, sometimes we had to tell students to redo work, and it is during these, sometimes difficult, decisions the responsibility for the whole is necessary.

Lastly, In Swedish we have the word *närvaro* which means being focused and present. One part is being present on site which was very important in supporting and help the

participants. It also include monitoring and respond to minor issues before they go out of control, but other times the pure presence is enough to keep the stress level down. Possibly the type of presence lacking at Lalibela. The other part is exercising the similar focus and presence during the design process which is more difficult to describe. Meaning that we had visualised and performed the experiment and its different stages several times in our minds already in the design process. The combination of visually see and modify the digital models and the drawings combined with building physical models before the workshop helped to grasp the experiment mentally. It could be similar to feeling described by Anton Bachleitner, director of the Düsseldorf Marionette Theater, in section 2.2.3, being present and at another place at the same time. However, it helped in the final tweaking, the last 5%, which takes proportionally much more time and energy than the previous 95%. Only if genuinely present the details and their importance and connection to the whole become truly clear. When seeing craftsmen and craftswomen work, I experience the same focus and commitment in their presence.

5.2 Sustainability - Digging where we stand

This thesis's introduction referred to the building industry's current and future challenge in connection to climate change. According to Melinda and Bill Gates, a city equivalent to New York City needs to be built every month until 2060 to accommodate the world's rising population. This thesis has described the structural benefits of shells structures and studied methods of facilitating the construction, one of the difficulties working with these structures. Under suitable conditions; these efficient structures can reduce the material required. Furthermore, the long life of Gothic Cathedrals, according to Professor Heyman (1995), is due to the low stresses, which is as a result of the efficient load paths. The example from The Mapungubwe Interpretive Centre showed that it is possible to use material of lesser structural properties and require less energy in the production. The project is relatively recent, so it will be interesting to see how well it performs over time.

However, the statement by Melinda and Bill Gates includes not only a challenge regarding GHG emissions but also the other dimensions connected to sustainability. Examples from Lalibela and the Mapungubwe Interpretive Centre show that it is much crucial *how* we solve a problem, and how it can create more problems or add value. Hence, the importance of establishing and contributing to a good building culture, as described in the 2018 Davos declaration, is much essential. If the roof structures in Lalibela are going to be dismantled, as discussed in the report by UNESCO/ICOMOS/ICCROM (2018), it has required much resources and time but with little, if any, added value. Thus, rebuilding a relatively new structure adds to the amount already described by Melinda and Bill Gates. It also seems to have caused the local communities much distress and probably distrust against international organisations and institutions, which is described as vertical relations connected to the social dimension of sustainable development in Hedenus et al. (2018). Thus, it can result in unexpected consequences in the future, indicating the importance of structural engineering. The Mapungubwe Interpretive Centre is a good example of the possibility of adding value, making people independent, and giving them

the tools to solve and maintain their structures and buildings, much crucial for both the economic and ecological dimension of sustainability. Similarly, an important aspect of the experiments in the papers presented in this thesis was to challenge ourselves to adapt to the situation's conditions and limitations. Furthermore, involve and teach people and hopefully contribute to a better building culture. If the 2018 Davos declaration will be successful or have much impact is difficult to say. There is a difficulty in measuring and monitoring a healthy building culture and put it into practice. Yet, it is often visible if one is part of the culture. According to Rosling et al. (2018), raising people's living standard might also decrease the population growth. Thus, solutions for the common good might reduce the quantity we need to build, described by Melinda and Bill Gates, a potential win-win for the climate and ourselves.

There is also this issue of materials, do we have to build in steel or concrete? All materials, timber, steel, reinforced concrete, and masonry have their particular use, which has been so in history and likely so in the future. Another aspect is learning to work with materials and limitations that we are not used to. When we worked with 6mm thick plywood boards, there were times where I wished that we had something better to work with, but since we could not afford it, we were forced to find a solution. It could be that engineers and architects in the future need to dig where they stand, using the resources in their neighbourhood. That is similar to the situation of the Gothic master builders. According to Viollet-le-Duc (1856) Gothic master builders had to use and work with the materials that were in their reach and learn how to process it and use it most efficiently and intelligently. Using the stone, soil and timber, they managed to build structures that have survived for nearly a thousand years.

By the end of the twelfth century, builders had moved and cut such a large quantity of stones that they had come to know exactly their properties, and to use these materials, because of these properties, with a very rare sagacity. So, it was not, as it is today, an easy thing to obtain ashlar; the means of transport and extraction were insufficient, it was necessary to provide oneself on the ground; it was not possible to obtain stones from distant origins: it was therefore by means of local resources that the architect had to raise his building, and often these resources were weak. We do not take enough account of these difficulties when appreciating the architecture of these times, and we often blame the architect, we consider as a childish desire to raise constructions surprising by their lightness, which is in reality only an extreme shortage of resources.¹ (Viollet-le-Duc 1856, p.127)

This aspect is as relevant today but receives as little attention as it did then. Similarly, it might be that materials will be higher valued in the future and that we cannot transport them very far, and as a consequence, the structures need to be more efficient and elaborate. Thus, it can be a comforting thought to think of our dead colleagues, the Gothic master builders, who managed to build such wonders with things within their reach. Sweden has a large amount of timber locally available. However, at the beginning of the 20th century Sweden had 500 brickyards (L.-E. Olsson 1987) in Sweden, and bricks were made less

¹Translated with the help of Dr. Robin Oval

than 100 km from Gothenburg. Thus, it is a shame that masonry for a long time has been neglected in both academia and practice in Sweden in the aspect of locally sourced building materials. Many of these structures have been in service for a long time and been able to handle unforeseen new conditions. There is less than a handful of structural engineers in Sweden that know how these structures work, and they are such an important part of history and our building stock, and they are much misunderstood. Thus, masonry and brickwork might still have a role to play in the future. Returning to the quote by Alexander et al. (1977)

The central problem of materials, then, is to find a collection of materials which are small in scale, easy to cut on site, easy to work on site without the aid of huge and expensive machinery, easy to vary and adapt, heavy enough to be solid, longlasting or easy to maintain, and yet easy to build, not needing specialised labor, not expensive in labor, and universally obtainable and cheap. (p.956)

Is it an imaginary material, or it is, as Carolyn Haynes (2019) state just a good description of a brick?

5.3 Conclusion

Geometry is still an excellent tool for problem-solving to be used in a design process, as it has ever been. The most important is to reestablish the historical connection between geometry and physics which have been successful in designing but also translating abstract phenomenons into theories. Geometry is our own construct and is more closely related to our mind and body than we can imagine. Thus, geometry is the key and should be the language in which architects, engineers and craftsmen and craftswomen communicate and convert their ideas. With geometry, the architect depicts space, the engineer imagines the equilibrium surfaces, the craftswoman weaves her patterns, and the physicist visualises the Universe, as it should be.

Digital tools combined with digital craftsmanship were essential to execute our experiments. It would have been difficult, or impossible, to exercise that level of control over the design, produce all the necessary information and data and visualise and communicate the different steps during the experiments. The possibility to simulate the experiments digitally before the experiments were crucial in getting a holistic perspective and mentally prepare. All of which is important when in the making of quality work and contributing to a healthy building culture. However, it was vital to combine it with physical models and prototypes to grasp the structural behaviour and evaluate its feasibility. It was often physical models and physical tests that made us confident to proceed in a specific path or made us change direction. Nonetheless, the experiments highlight the strength of combining digital tools and geometry early in the design process to facilitate the integration between space, structure, construction, and rapid manufacturing.

5.4 Future research

There are several directions in which the work can continue from this thesis and I will mention a few:

1. *Geometry*. There is more work to be done in field of differential geometry concerning architecture and engineering. For instance, the last paper on surfaces on constant angles can be taken further by applying different patterns.
2. *Masonry bridges* - According to McKibbins (2006) old masonry bridges have been more much more durable in comparison to modern concrete bridges. If to find a substitute for reinforced concrete in infrastructure projects masonry might be an alternative. There are two aspects which are linked to history, which might be worth reconsidering. The first one is to use geometry to work with these structure in three dimensions to utilise membrane action as much as possible and find ways to manufacture and erect these masonry bridges. The second aspect is to look at the interaction between the fill and the shell. In masonry bridges and viaducts there is a large portion of soil fill inside, in which the masonry shells act as a container for the fill. Fill have sometimes been treated just as an added weight for stability, but there could be much more to explore regarding the soil and structure interaction.
3. *Digital craftsmanship - The hand and head marriage*. Many craftsmen I have spoken to, including my father, like their work. There might exist a parallel path of the future, where people want to continue work with their hands and body because, if believing Wilson (1998), we are biologically developed that way. That would be different from the workshops we do with our students, working more closely with craftsmen and craftswomen. Developing something together utilising their experience and tacit knowledge would be an interesting and possible path.

Picture credits

Unless nothing else is stated, the pictures are either the authors or under public domain. Several images in this thesis have been licensed under public domain or Creative Commons. Information regarding the different licenses can be found here:

© 1.0: <https://creativecommons.org/publicdomain/mark/1.0/deed.en>
©0 CC0 1.0: <https://creativecommons.org/publicdomain/zero/1.0/>
©i CC BY 2.0 2.0: <https://creativecommons.org/licenses/by/2.0/>
©i© CC BY-SA 3.0: <https://creativecommons.org/licenses/by-sa/3.0/>
©i© CC BY-SA 4.0: <https://creativecommons.org/licenses/by-sa/4.0/>
©i©© CC BY-NC-ND 2.0: <https://creativecommons.org/licenses/by-nc-nd/2.0/>

Figure 1.1

over a bed of pins (ii), photo by Ciro Mondueri licensed under ©i CC BY 2.0, <https://flic.kr/p/yVJC1>

Figure 2.1a

Jar (Hu), licensed under ©0 CC0 1.0 by The Metropolitan Museum of Art. <https://www.metmuseum.org/art/collection/search/44723>

Figure 2.5

Armadillo Vault, photo by Iwan Baan licensed under ©i©© CC BY-NC-ND 2.0, <https://flic.kr/p/MdvmiH>

Figure 2.17

Construcción de uno de los cajones para el Puente de Sancti Petri. I-ETM-018-07_02, photo used with permission from the Archivo Torroja, <http://www.cehopu.cedex.es/etm/pict/I-ETM-018-07.htm>

Figure 2.18a

it's hippo feeding time!, photo by nayrb7 licensed under ©i CC BY 2.0, <https://flic.kr/p/FzGBf>

Figure 2.18b

Zoo Berlin, building for hippopotamusses, exterior., photo by Manfred Brückels licensed under ©i© CC BY-SA 3.0 <https://commons.wikimedia.org/w/index.php?curid=12608719>

Figure 2.19

Rafael Guastavino stands on recently laid tile arch along Boylston Street, construction of the McKim Building, photo by Boston Public Library licensed under ©i CC BY 2.0 <https://flic.kr/p/4D3P2Y>

Figure 2.21

Beta Maryam, Lalibela, Ethiopia, photo by Bernard Gagno licensed under ©i© CC BY-SA 3.0 <https://commons.wikimedia.org/w/index.php?curid=28198310>

Figure 2.22a


Vue du Limpopo en Afrique du Sud, photo by South African Tourism licensed under  CC BY 2.0 <https://commons.wikimedia.org/w/index.php?curid=67747409>

Figure 2.22b

Mapungubwe, Limpopo, South Africa, photo by South African Tourism licensed under  CC BY 2.0 <https://flic.kr/p/xg6B8y>

Figure 2.25


Photo by Nederlandse Spoorwegen licensed under  CC0 1.0 <https://commons.wikimedia.org/w/index.php?curid=91981159>

Figure 2.26


Cambridge Central Mosque main prayer hall in May 2019, photo by cmglee licensed under  CC BY-SA 4.0, <https://commons.wikimedia.org/w/index.php?curid=91981159>

Figure 3.1


Soap Bubbles by Jean Jacques de Boissieu, distributed under licence  CC0 1.0 by The Metropolitan Museum of Art, <https://www.metmuseum.org/art/collection/search/343540>

Figure 3.2

Oak room roof, photo by Mark Dries licensed under  CC BY-NC-ND 2.0, <https://flic.kr/p/2gWMSuH>

Figure 3.3

Maqueta polifuncional de la iglesia de la Colonia Güell, de Antoni Gaudí (1898-1908), distributed under Public Domain, <https://commons.wikimedia.org/w/index.php?curid=4524156>

Figure 3.4

Watson and Crick with their DNA model. [Photography]. Retrieved from Encyclopædia Britannica ImageQuest. https://quest.eb.com/search/132_1256566/1/132_1256566/cite

References

- Ackerman, J. S. (1949). "Ars Sine Scientia Nihil Est" Gothic Theory of Architecture at the Cathedral of Milan. *The Art Bulletin* **31.2**, 84–111. ISSN: 00043079. DOI: 10.2307/3047224.
- Addis, B. (2007). *3,000 Years of Design, Engineering, and Construction*. Phaidon Press; p. 640.
- Adiels, E. (2019a). *Test rig for evaluating the capacity of the laths*. on Vimeo. URL: <https://vimeo.com/338556892> (visited on 05/26/2019).
- Adiels, E., N. Bencini, C. Brandt-Olsen, I. Naslund, et al. (2018). *Github repository*. URL: <https://github.com/archengtech/chalmersworkshop-dec2017>.
- Adiels, E. (2016). "Structural influence of the geometry of masonry vaults: Brick tiling patterns for compression shells using geodesic coordinates". MSc Thesis. Chalmers University of Technology. DOI: 10.13140/RG.2.2.23041.71521.
- (2018). *Workshop exploring crafts and structural behaviour of masonry, Mariestad, 2017 on Vimeo*. URL: <https://vimeo.com/254638151> (visited on 05/29/2019).
- (2019b). *Asymptotic Gridshell - Timelapse on Vimeo*. URL: <https://vimeo.com/337822771> (visited on 05/29/2019).
- (2019c). *Evaluating the curvature limit of the laths during the design process of the asymptotic gridshell on Vimeo*. URL: <https://vimeo.com/338520213>.
- (2019d). *Evaluating the global stability of the design of the asymptotic gridshell through small scale model on Vimeo*. URL: <https://vimeo.com/338261338> (visited on 05/26/2019).
- (2019e). *Simulating the erection procedure of the Asymptotic gridshell on Vimeo*. URL: <https://vimeo.com/312943826> (visited on 05/23/2019).
- (2019f). *Test rig for evaluating the capacity of the laths of the asymptotic gridshell*. on Vimeo. URL: <https://vimeo.com/338556892> (visited on 05/29/2019).
- (2020). *The composition of matter, space, time and structure in masonry and concrete vaults*. URL: <https://vimeo.com/showcase/5361926> (visited on 01/25/2021).
- (n.d.a). *Architecture and Engineering Workshops*. URL: <https://vimeo.com/showcase/5361928> (visited on 01/25/2021).
- (Expected 2021). *The historical and technical development of masonry structures*.
- Adiels, E., M. Ander, and C. J. K. Williams (2019). "Surfaces defined by the points at which a closed curve subtends a constant solid angle". *Proceedings of the Diderot Mathematical Forum*.
- Adiels, E., M. Ander, and C. J. K. Williams (2017). "Brick patterns on shells using geodesic coordinates". *IASS Annual Symposium 2017 "Interfaces: Architecture . Engineering. Science"*. September, pp. 1–10.
- Adiels, E., N. Bencini, C. Brandt-Olsen, A. Fisher, et al. (2018). "Design , fabrication and assembly of a geodesic gridshell in a student workshop". *IASS Symposium 2018 "Creativity in Structural Design"*, pp. 1–8.
- Adiels, E., C. Brandt-Olsen, J. Isaksson, I. Näslund, K.-G. Olsson, et al. (2019). "The design , fabrication and assembly of an asymptotic timber gridshell". *Proceedings of*

- the IASS Annual Symposium 2019 - Structural Membranes 2019. October. Barcelona, pp. 1–8.
- Adiels, E., C. Brandt-Olsen, J. Isaksson, I. Näslund, and E. Poulsen (2019). *GitHub repository*. URL: <https://github.com/archengtech/chalmersworkshop-dec2018> (visited on 05/26/2019).
- Adiels, E. (2019g). *Plywood structure from asymptotic curves of an Enneper surface on Vimeo*. URL: <https://vimeo.com/311905217> (visited on 05/23/2019).
- Adriaenssens, S. (2019). *What I am thinking: movie maker and masonry specialist Emil Adiels*. URL: <https://formfindinglab.wordpress.com/2019/02/28/what-i-am-thinking-movie-maker-and-masonry-specialist-emil-adiels/> (visited on 07/07/2020).
- Adriaenssens, S., M. Barnes, et al. (2014). “Designed of a strained timber gridshell”. *Shell Structures for Architecture: Form Finding and Optimization*. Routledge, pp. 89–102.
- Adriaenssens, S., L. Ney, et al. (2012). Finding the form of an irregular meshed steel and glass shell based on construction constraints. *Journal of Architectural Engineering* **18.3**, 206–213. ISSN: 10760431. DOI: 10.1061/(ASCE)AE.1943-5568.0000074.
- Airy, G. B. (1863). On the Strains in the Interior of Beams. *Philosophical Transactions of the Royal Society of London* **153**, 49–79. URL: <https://www.jstor.org/stable/108789>.
- Aish, F. et al. (Apr. 2015). The Use of a Particle Method for the Modelling of Isotropic Membrane Stress for the Form Finding of Shell Structures. *Computer-Aided Design* **61.C**, 24–31.
- Alexander, C. et al. (1977). *A pattern language : towns, buildings, construction*. Center for environmental structure series: 2. Oxford U.P. ISBN: 0195019199.
- Allen, E. and W. Zalewski (2009). *Form and Forces: Designing Efficient, Expressive Structures*. WILEY, p. 620. ISBN: 9780470174654.
- Anderson, S., ed. (2003). *Eladio Dieste: Innovation in Structural Art*. New York: Princeton Architectural Press. ISBN: 9781616890025. URL: http://archnet.org/library/documents/one-document.jsp?document%7B%5C_%7Ddid=4784.
- Arlander, A. (2014). “On Methods of Artistic Research”. *Method - Process - Reporting: Articles, reviews and reports of the ongoing development on artistic research*. Chap. 1, pp. 26–39.
- Axelrad, E. L. and F. A. Emmerling (1988). Vector and tensor form of intrinsic shell-theory relations. *International Journal of Non-Linear Mechanics* **23.1**, 9–23.
- Bannister, T. C. (1968). The Roussillon Vault : The Apotheosis of a ” Folk ” Construction The Roussillon Vault The Apotheosis of a ” Folk ” Construction. *Journal of the Society of Architectural Historians* **27.3**, 163–175.
- Barnes, M. R. (1988). Form-Finding and analysis of prestressed nets and membranes. **30.3**.
- (1977). “Form finding and analysis of tension space structures by dynamic relaxation.” PhD thesis. City University London.
- Bell, C. (1834). *The hand; its mechanism and vital endowments, as evincing design*. London : W. Pickering.
- Benvenuto, E. (1991). *An Introduction to the History of Structural Mechanics. Part II: Vaulted Structures and Elastic Systems*. Springer New York. ISBN: 9781461277514.

- Billington, D. P. (1965). *Thin shell concrete structures*. McGraw-Hill.
- Bix, R. A. and H. J. D'Souza (2020). *Analytic geometry*. URL: <https://www.britannica.com/science/analytic-geometry> (visited on 2020).
- Block, P., L. Davis, et al. (2010). Tile vaulted systems for low-cost construction in Africa. *African Technology Development Forum* **7.1**, 4–13.
- Block, P. and J. Ochsendorf (2007). Thrust network analysis: A new methodology for three-dimensional equilibrium. *Journal of the International Association for Shell and Spatial Structures* **48.155**, 167–173. ISSN: 1028365X.
- Block, P., T. Van Mele, et al. (2017). *Beyond Bending: Reimagining Compression Shells*. Detail Business Information GmbH.
- Borgdorff, H. (2007). The Debate on Research in the Arts. *Dutch Journal of Music Theory* **12.1**, 1–17.
- Bornemark, J. (2018). *Det omätbaras renässans – en uppgörelse medpedanternas världsherravälde*. Stockholm: Volante. ISBN: 978-91-88869-24-1.
- Calladine, C. R. (1982). The theory of shell structures: Aims and methods. *International Journal of Mechanical Sciences* **24.4**, 219–230.
- Campbell, J. (2003). *Brick: A world history*. London: Thames & Hudson Ltd. ISBN: 0-500-34195-8.
- Capecchi, D. (2012). *History of Virtual Work Laws*. Springer-Verlag Italia.
- Carmo, M. do (1976). *Differential geometry of curves and surfaces*. DOI: 10.1007/978-3-319-39799-3.
- Carneau, P. et al. (2019). “An exploration of 3d printing design space inspired by masonry”. *IASS Symposium 2019, "Form and Force"*. October. Barcelona. DOI: 10.5281/zenodo.3563672.
- Chace, A. B. and H. P. Mannin (1927). *The Rhind Papyrus Volume 1: British Museum 10057 and 10058*. Oberlin, Ohio, USA: Mathematical Association of America.
- Chalmers (2019). *The Structural Design Day: Freeform Timber Structures – Architecture and Manufacture-aware Design*. URL: <https://www.chalmers.se/sv/centrum/konstruktionscentrum/kalendarium/Sidor/Design--och-konstruktionsdagen-2019.aspx> (visited on 01/08/2021).
- Chebyshev, P. L. (1887/1946). On the cutting of garments. *Uspekhi Mat. Nauk* **1**.Issue 2(12), 38–42. DOI: 10.18287/0134-2452-2015-39-4-459-461..
- Collins, G. R. (1963). Antonio Gaudi : Structure and Form. *Perspecta* **8**, 63–90.
- (1960). *Antonio Gaudí*. New York: George Braziller Inc.
- (1968). The transfer of thin masonry vaulting from Spain to America. *Journal of the Society of Architectural Historians* **27.3**, 176–201. ISSN: 0037-9808.
- Cosserat, E. and F. Cosserat (1909). *Théorie des corps déformables*. A. Hermann et fils.
- Cremona, L. (1872). *Le figure reciproche nella statica grafica*. ita. Milano: Tipografia di Giuseppe Bernardoni, 44 S., [1] Bl. 5 Taf., 24 cm CN – ETH-Bibliothek Zürich, Rar 1127. DOI: 10.3931/e-rara-18757. URL: <https://doi.org/10.3931/e-rara-18757>.
- Crisfield, M. (1997). *Non-linear finite element analysis of solids and structures*. 2nd ed. Vol. 2: Advanced Topics. Wiley.
- Culmann, C. (1866). *Die graphische Statik*. ger. Zürich: Meyer & Zeller, Text- und Tafelband, Textbd.: 23 cm, Tafelbd.: 24x34 cm CN – ETH-Bibliothek Zürich, Rar 4547:

- TEX ex. A. DOI: 10.3931/e-rara-20052. URL: <https://doi.org/10.3931/e-rara-20052>.
- Darwin, C. (1871). *The Descent of man*. D. Appleton and Co. ISBN: 9783540773405. URL: <https://archive.org/embed/descentman00darwgoog>.
- Day, A. S. (1965). An introduction to Dynamic Relaxation. *The Engineer*.
- Delataille, É. (1887). Art du trait pratique de charpente / par Émile Delataille ... URL: <https://gallica.bnf.fr/ark:/12148/bpt6k8505503/f2.item.langFR%7B%5C#%7D>.
- Delorme, P. (1567). Le Premier tome de l'Architecture de Philibert de L'Orme ... URL: <http://www.mdz-nbn-resolving.de/urn/resolver.pl?urn=urn:nbn:de:bvb:12-bsb10195337-1>.
- Derand, F. (1643). *L'Architecture des voûtes, ou l'Art des traits et coupe des voûtes... par le R. P. François Derand,...* S. Cramoisy.
- Dirac, P. A. M. (1975). *General Theory of Relativity*. Wiley.
- (1975). *General Theory of Relativity*.
- Dörfler, K., T. Sandy, and M. Gifthaler (2016). Robotic Fabrication in Architecture, Art and Design 2016. *Robotic Fabrication in Architecture, Art and Design 2016* February 2016. DOI: 10.1007/978-3-319-26378-6.
- Drew, P. (1976). *Frei Otto: Form and Structure*. Westview Press. ISBN: 978-0891585350.
- Edwards, E. P. (1884). *Our Seamarks: A Plain Account of the Lighthouses, Lightships, Beacons, Buoys, and Fog-Signals Maintained on our Coasts for the Guidance of Mariners*. Longmans, Green & Co. URL: <http://access.bl.uk/item/pdf/lsidyv3c6cb808>.
- Einstein, A. (1920). *Relativity; the special and general theory*. Trans. by R. W. Lawson. New York: Hentry Holt and Company. URL: <https://archive.org/embed/cu31924011804774>.
- Eisenhart, L. P. (1947). *An introduction to differential geometry, with use of the tensor calculus*. Princeton University Press.
- Eriksson, F. (1990). On the Measure of Solid Angles. *Mathematics Magazine* **63**.3, 184–187. ISSN: 0025570X, 19300980. URL: <http://www.jstor.org/stable/2691141>.
- Euler, L. (1767). Recherches sur la courbure des surfaces. *Mémoires de l'academie des sciences de Berlin* **16**, 119–143.
- Falk, A. and S. Samuelsson (2004). “Timber plates in tensile structures”. *IASS 2004. Shell and Spatial Structures from Models to Realization*. Ed. by R. Motro. Editions de l'Esperou, pp. 254–255.
- Fitchen, J. (1961). *The construction of gothic cathedrals: A study of medieval vault erection*. Oxford University Press.
- Flügge, W. (1973). *Stresses in Shells*. Berlin: Springer-Verlag.
- Fontana, C. (1694). *Il Tempio Vaticano e sua origine : con gl'edifitii più cospicui, antichi e moderni, fatti dentro e fuori di esso*. In Roma : Nella stamperia di Gio. Francesco Buagni. URL: https://archive.org/details/gri%7B%5C_%7D33125008467413/page/n11/mode/2up.
- Forest Europe (2015). State of Europe's Forests 2015. URL: <https://foresteurope.org/state-europes-forests-2015-report/>.
- Frankl, P. (1962). *Gothic Architecture*. Penguin Books.

- Frayling, C. (1993). Research in Art and Design. *Royal College of Art Research Papers* 1.1, 1–5.
- Fuller, R. B. (1954). *Building Construction [U.S. Patent 2,682,235]*. URL: pdfpiw.uspto.gov/.piw?docid=02682235.
- Gates, B. and M. Gates (2019). *Our 2019 Annual Letter: Things We Didn't See Coming*. URL: <https://www.gatesnotes.com/media/AL2019/PDFs/2019AnnualLetter-EN.pdf>.
- Gauss, K. F. (1825/1827/1902). General Investigations of Curved Surfaces of 1827 and 1825. Translated by Morehead J. C. and Hildebeitel A. M. *The Mathematical Gazette* 2.35. (Original work published 1825 and 1827), 215. ISSN: 00255572. DOI: 10.2307/3604249.
- Geib, P. R. and E. A. Jolie (2008). The role of basketry in early holocene small seed exploitation: Implications of a ca. 9,000 year-old basket from Cowboy Cave, Utah. *American Antiquity* 73.1, 83–102. ISSN: 00027316. DOI: 10.1017/S0002731600041299.
- Glymph, J. et al. (2004). A parametric strategy for free-form glass structures using quadrilateral planar facets. *Automation in Construction* 13.2, 187–202.
- Gooding, D. (1985). “In Nature’s School’: Faraday as an Experimentalist”. *Faraday Rediscovered: Essays on the Life and Work of Michael Faraday, 1791-1867*. Ed. by D. Gooding and F. A. J. L. James. THE MACMILLAN PRESS LTD.
- Green, A. E. and W. Zerna (1968). *Theoretical elasticity*. 2nd. Oxford: Oxford University Press.
- (1968). *Theoretical elasticity*. 2nd. Oxford University Press. ISBN: 978-0-486-67076-8.
- Grøn, Ø. and A. Næss (2011). *Einstein’s Theory : a rigorous introduction for the mathematically untrained*. ISBN: 978-1-4614-0705-8. DOI: <https://doi-org.proxy.lib.chalmers.se/10.1007/978-1-4614-0706-5>.
- Güler, E. (2018). Family of Enneper Minimal Surfaces. *Mathematics* 6.12, 281. DOI: 10.3390/math6120281.
- Hammond, M. and J. Wellington (2021). *Research Methods; The Key Concepts; Second Edition*. Routledge. ISBN: 9780367178734.
- Happold, E. and W. I. Liddell (1975). Timber Lattice Roof for the Mannheim Bundesparkgartenschau. *Structural Engineer* 53.3, 99–135. ISSN: 14665123.
- Harding, J. et al. (2014). The Ongreening Pavilion. *Advances in Architectural Geometry 2014*, 295–308. DOI: 10.1007/978-3-319-11418-7_19. URL: http://link.springer.com/10.1007/978-3-319-11418-7_19.
- Harding, J. E. et al. (2017). “The UWE Research Pavilion 2016”. *Proceedings of the IASS Annual Symposium 2017 “Interfaces: architecture.engineering.science”*. Hamburg.
- Hauberg, J. (2011). Research by Design - a research strategy. *AE... Revista Lusófona de Arquitectura e Educação* 5, 46–56. URL: <https://revistas.ulusofona.pt/index.php/revlae/issue/view/213>.
- Haynes, C. (2019). *Brick: A Social History*. The History Press. ISBN: 978-0750991933.
- Hedenus, F., M. Persson, and F. Sprei (2018). *Sustainable developmen: Nuances and perspectives*. Lund: Studentlitteratur AB.
- Heilbron, J. L. (2020). *Geometry*. URL: <https://www.britannica.com/science/geometry> (visited on 2020).
- Herodotus (440 B.C). The History of Herodotus. Trans. by G. Rawlinson. 2. URL: <http://classics.mit.edu/Herodotus/history.2.ii.html>.

- Heyman, J. (1995). *The Stone Skeleton: Structural Engineering of Masonry Architecture*. Cambridge University Press.
- (2015). *Jacques Heyman, The membrane analysis of thin masonry shells*. URL: https://www.youtube.com/watch?v=DI-1eSI68dM%7B%5C%7Dfeature=youtu.be%7B%5C%7Dab%7B%5C_%7Dchannel=BibliothecaMechanico-Architectonica.
- Hughes, T. J., J. A. Cottrell, and Y. Bazilevs (2005). Isogeometric analysis: CAD, finite elements, NURBS, exact geometry and mesh refinement. *Computer Methods in Applied Mechanics and Engineering* **194**.39-41, 4135–4195. ISSN: 00457825. DOI: 10.1016/j.cma.2004.10.008.
- Hyde, S. et al. (1997). “The Mathematics of Curvature”. *The Language of Shape*, pp. 1–42. DOI: 10.1016/b978-044481538-5/50002-2.
- IEA (2019). *Global Status Report for Buildings and Construction 2019*. Tech. rep. Paris. URL: <https://www.iea.org/reports/global-status-report-for-buildings-and-construction-2019>.
- Joachimsthal, F. (1846). Demonstrationes theorematum ad superficies curvas spectantium. *Journal für die reine und angewandte Mathematik (Crelles Journal)* **30**, 347–350. DOI: <https://doi.org/10.1515/crll.1846.30.347>.
- Jones, H. B. (1870). *The life and letters of Faraday*. London: Longmans, Green & Co. URL: <https://archive.org/embed/lifelettersoffa02jone>.
- Kurrer, K.-E. (2008). *The history of the theory of structures - From arch analysis to the computational mechanics*. Berlin: Ernst & Sohn Verlag für Architektur und technische Wissenschaften GmbH & Co.
- L’Orme, P. de (1567). *Le premier tome de l’ Architecture de Philibert de de l’Orme*. chez Federic Morel. URL: <http://architectura.cesr.univ-tours.fr/traite/Images/Les1653Index.asp>.
- Linkwitz, K. and H. J. Schek (1971). *Einige Bemerkungen zur Berechnung von vorgespannten Seilnetzkonstruktionen*. DOI: 10.1007/BF00532146. URL: <https://www.deepdyve.com/lp/springer-journals/einige-bemerkungen-zur-berechnung-von-vorgespannten-wTkaLYB3e2>.
- Mainstone, R. J. (1981). “The Eddystone Lighthouse”. *John Smeaton FRS*. Ed. by A. W. Skempton. Tomas Telford Limited, pp. 83–102.
- Malek, S. R. (2012). “The Effect of Geometry and Topology on the Mechanics of Grid Shells”. PhD thesis. Massachusetts Institute of Technology, p. 131.
- Manzanares, G. L. (2003). “The XVIIth century: Carlo Fontana’s expertises”. *First International Congress on Construction History*. January. Madrid.
- Maxwell, J. C. (1874). PLATEAU ON SOAP-BUBBLES. *Nature* **X**.242, 119–121.
- Maxwell, J. C. (1864). XLV. On reciprocal figures and diagrams of forces. *The London, Edinburgh, and Dublin Philosophical Magazine and Journal of Science* **27**.182, 250–261. ISSN: 1941-5982. DOI: 10.1080/14786446408643663.
- McKibbins, L. D. et al. (2006). *Masonry arch bridges: condition appraisal and remedial treatment*. Tech. rep.
- McRobie, A. (2017). *The seduction of curves: The lines of beauty that connect mathematics, art, and the nude*. Princeton University Press. ISBN: 9780691175331.

- Mitterberger, D. et al. (2020). Augmented bricklaying. *Construction Robotics* 4.3-4, 151–161. ISSN: 2509-811X. DOI: 10.1007/s41693-020-00035-8. URL: <https://doi.org/10.1007/s41693-020-00035-8>.
- Monge, G. (1798). *Géométrie descriptive*. fre. Paris: Baudouin. DOI: 10.3931/e-rara-4796. URL: <https://doi.org/10.3931/e-rara-4796>.
- Motamedi, M. et al. (2020). “Supportless 3D Printing of Shells: Adaptation of Ancient Vaulting Techniques to Digital Fabrication”. *Impact: Design With All Senses*. ISBN: 9783030298296. DOI: 10.1007/978-3-030-29829-6.
- Nutbourne, A. W. (1984). “A circle diagram for local differential geometry”. *The mathematics of surfaces*. Ed. by J. A. Gregory, pp. 59–71.
- Ochsendorf, J. (2003). Eduardo Torroja and «Cerámica Armada». January.
- (2010). *Guastavino Vaulting: The Art of Structural Tile*. New York: Princeton Architectural Press.
- Olsson, L.-E. (1987). *Tegelbruk*. Riksantikvarieämbetet, Sveriges Tegelinstitut. Sveriges Tegelinstitut.
- Ottosen, N. and H. Petersson (1992). *Introduction to the finite element method*. Pearson Education. ISBN: 0-13-473877-2.
- Paulsson, G. (1936). *Hantverkets Bok: 4, Mureri*. Lindfors bokförlag.
- Paulsson, G. and H. Granholm (1953). *Hantverkets bok. Mureri. 3., omarb. uppl.* Lindfors.
- Peters, B. and T. Peters, eds. (2013). *Inside Smart Geometry: Expanding the Architectural Possibilities of Computational Design*. John Wiley & Sons. ISBN: 978-1-118-52247-9.
- Plateau, J. (1873). *Statique expérimentale et théorique des liquides soumis aux seules forces moléculaires*.
- (1873/2005). Experimental and theoretical statics of liquids subject to molecular forces only. Trans. by K. A. Brakke. (Original work published 1837).
- Poleni, G. (1748). *Memorie Istoriche della Gran Cupola del Tempio Vaticano*, p. 470. URL: <https://www.e-rara.ch/zut/wihibe/content/titleinfo/4079847>.
- Poncelet, J. V. (1822). *Traité des propriétés projectives des figures: ouvrage utile à ceux qui s'occupent des applications de la géométrie descriptive et d'opérations géométriques sur le terrain*. fre. Paris: Bachelier, Libraire, XLVI, 426 S., [1] Bl., 12 Faltafeln, 26 cm (4°) CN – ETH-Bibliothek Zürich, Rar 21112. DOI: 10.3931/e-rara-55268. URL: <https://doi.org/10.3931/e-rara-55268>.
- Pottmann, H., S. Brell-Cokcan, and J. Wallner (2007). “Discrete Surfaces for Architectural Design”. *Curves and Surface Design: Avignon 2006*. Ed. by P. Chenin, T. Lyche, and L. L. Schumaker. Nashboro Press, pp. 213–234. ISBN: 978-0-9728482-7-5.
- Pottmann, H., Q. Huang, et al. (2010). Geodesic patterns. *ACM Transactions on Graphics* 29.4, 1. ISSN: 07300301. DOI: 10.1145/1833351.1778780. URL: <http://portal.acm.org/citation.cfm?doid=1833351.1778780>.
- Poulsen, E. (2015). “Structural design and analysis of elastically bent gridshells - The development of a numerical simulation tool”. PhD thesis. Chalmers University of Technology, p. 77.
- Prager, F. D. and G. Scaglia (1970). *Brunelleschi: Studies of His Technology and Inventions*. Dover publications.
- Pressley, A. (2009). *Elementary Differential Geometry*. Springer London Ltd. ISBN: 9781848828902.

- Prime, W. C. (1860). *Boat life in Egypt and Nubia*. New York: Harper & Brothers. URL: <https://archive.org/embed/boatlifeinegyptn00prim>.
- Pryce, W. (2005). *Architecture in Wood : A World History*. Thames & Hudson Ltd. ISBN: 978-0-500-34318-0.
- Ramage, M. H. et al. (2010). Design and Construction of the Mapungubwe National Park Interpretive Centre, South Africa. *ATDF JOURNAL* 7.1/2, 14–23.
- Riedelsheimer, T. (2001). *Rivers and Tides*.
- Rippmann, M. et al. (2018). Design, fabrication and testing of discrete 3D sand-printed floor prototypes. *Materials Today Communications* 15, March, 254–259. ISSN: 23524928. DOI: 10.1016/j.mtcomm.2018.03.005. URL: <https://doi.org/10.1016/j.mtcomm.2018.03.005>.
- Robbins, E. (1997). *Why architects draw*. MIT Press. ISBN: 0-262-18157-6.
- Robert McNeel & Associates (2017). *RhinoCommon SDK*. <http://developer.rhino3d.com/api/RhinoCommon/>. [Online; accessed 1-April-2017].
- Rosenfeld, B. (1988). *A History of Non-Euclidean Geometry - Evolution of the Concept of a Geometric Space*. Ed. by G. Toomer. New York: Springer Science+Business Media.
- Rosling, O., A. Rosling Rönnlund, and O. Rosling (2018). *Factfulness: tio knep som hjälper dig att förstå världen*. 1st ed. Stockholm: Natur & Kultur.
- Rottlaender, R. C. (1977). On the mathematical connections of ancient measures of length. *Acta Praehistorica and Archaeologica*, 49–51.
- Rubió i Bellver, J. (1913). Dificultats per a arribar a la sintesis arquitectònica. *Anuario de la Asociación de Arquitectos de Cataluña*, 63–79.
- Saint-Exupéry, A. (1939). *Wind Sand And Stars*. New York: Reynal & Hitchcock. URL: <https://archive.org/embed/in.ernet.dli.2015.264850>.
- Salvadori, M. and R. Heller (1963). *Structure in Architecture: the Building of Buildings*.
- Schek, H. J. (1974). The force density method for form finding and computation of general networks. *Computer Methods in Applied Mechanics and Engineering* 3.1, 115–134. ISSN: 00457825. DOI: 10.1016/0045-7825(74)90045-0.
- Scherrer, D. (2015). Ancient Observatories - Timeless Knowledge, 1–43.
- Schlaich, J. and M. Schlaich (2008). Lightweight structures.
- Schlaich, J. and H. Schober (1996). Glass-covered grid-shells. *Structural Engineering International: Journal of the International Association for Bridge and Structural Engineering (IABSE)* 6.2, 88–90. ISSN: 10168664. DOI: 10.2749/101686696780495716.
- Schlaich, J. (1991). “Bridging the Gap: Rethinking the Relationship of Architect and Engineer”. *Bridging the gap: Rethinking the realtionship of architect and engineer*. New York: Van Nostrand Reinhold. Chap. 7, pp. 109–122.
- Schlaich, J. and H. Schober (2005). Freeform Glass Roofs. March, 25–27.
- Schling, E. et al. (2018). “Design and construction of curved support structures with repetitive parameters”. *Advances in Architectural Geometry*. Ed. by L. Hesselgren et al. Gothenburg: Klein Publishing GmbH (Ltd.), pp. 140–165.
- Schön, D. A. (1992). Designing as reflective conversation with the materials of a design situation. *Knowledge-Based Systems* 5.1, 3–14. ISSN: 09507051. DOI: 10.1016/0950-7051(92)90020-G.
- Scriba, C. J. and P. Schreiber (2015). *5000 years of geometry: Mathematics in history and culture*, pp. 1–626. ISBN: 9783034808989. DOI: 10.1007/978-3-0348-0898-9.

- Sennett, R. (2008). *The Craftsman*. Yale University Press. ISBN: 9780300149555.
- (2016). *Richard Sennett: Craftsmanship*. URL: <https://youtu.be/nIq4w9brxTk>.
- Shelby, L. R. (1972). The Geometrical Knowledge Of Mediaeval Master Masons. *Speculum* **47.3**, 395–421. ISSN: 20408072. DOI: 10.2307/2856152.
- Smartgeometry (n.d.). *sg2016 Gothenburg — smartgeometry*. URL: <https://www.smartgeometry.org/sg2016-göthenburg> (visited on 01/24/2021).
- Smeaton, J. (1791). *A narrative of the building and a description of the construction of the Edystone Lighthouse with stone : to which is subjoined, an appendix, giving some account of the lighthouse on the Spurn Point, built upon a sand*. London : Printed for the author by H. Hughs, sold by G. Nicol.
- Smith, N. (1981). “Scientific work”. *John Smeaton FRS*. Ed. by A. W. Skempton. Tomas Telford Limited, pp. 35–57.
- Soriano, E. (2017). Low-Tech Geodesic Gridshell: Almond Pavilion. February.
- Stevenson, R. (1824). An account of the Bell Rock light-house. URL: <https://archive.org/embed/stevensonbell1824stev>.
- Stoker, J. J. (1969). *Differential Geometry*. New York: Wiley-Interscience.
- Strauss, W. A. (2008). *Partial Differential Equations : An Introduction*. 2nd. John Wiley & Sons Inc.
- Struik, D. J. (1961). *Lectures on Classical Differential Geometry*. Addison-Wesley.
- Struik, D. J. (1987). *A concise history of mathematics*. 4 Revised. Dover Publications Inc., p. 256. ISBN: 9780486602554.
- (1988). *Lectures on classical differential geometry*. 2nd. Dover. ISBN: 9780486656090.
- Sun, X. et al. (2016). “Vertex Normals and Face Curvatures of Triangle Meshes”. *Advances in Discrete Differential Geometry*. Ed. by A. I. Bobenko. Berlin, Heidelberg: Springer Berlin Heidelberg, pp. 267–286. ISBN: 978-3-662-50447-5. DOI: 10.1007/978-3-662-50447-5_8. URL: https://doi.org/10.1007/978-3-662-50447-5_8.
- Davos Declaration 2018. Towards a European vision of high-quality Baukultur (2018a). Ed. by Swiss federal Office of Culture. Context document to the Davos Declaration 2018. URL: <https://davosdeclaration2018.ch/media/Context-document-en.pdf>.
- Davos Declaration 2018. Towards a high quality Baukultur for Europe (2018b). Ed. by Swiss federal Office of Culture. URL: <https://davosdeclaration2018.ch/>.
- Tarrago, S. (1985). *Gaudí : literary text, advising, technical and graphical information*. 8. ed. Escudo de Oro. ISBN: 84-378-0146-x.
- Tesfaye, M. (2013). *Kloge hænder*. Gyldendal. ISBN: 978-87-02-15079-7.
- Thompson, D. W. (1917). *On growth and form*. Cambridge University press. URL: <https://archive.org/details/ongrowthform1917thom>.
- Timoshenko, S. (1934). *Theory of elasticity*. McGraw-Hill, p. 416.
- Timoshenko, S. and S. Woinowsky-Krieger (1959). *Theory of plates and shells*. 2nd. McGraw-Hill.
- Timoshenko, S. and S. Woinowsk-Krieger (1959). *Theory of plates and shells*. 2nd. McGraw-Hill.
- Timoshenko, S. P. (1921). LXVI. On the correction for shear of the differential equation for transverse vibrations of prismatic bars. *The London, Edinburgh, and Dublin Philosophical Magazine and Journal of Science* **41.245**, 744–746.

- UNESCO/ICOMOS/ICCROM (2018). *Report of the UNESCO/ICOMOS/ICCROM Advisory mission to Rock-Hewn Churches, Lalibela (Ethiopia)*. Tech. rep. URL: <https://whc.unesco.org/document/169702>.
- Veenendaal, D. and P. Block (2012). An overview and comparison of structural form finding methods for general networks. *International Journal of Solids and Structures* **49.26**, 3741–3753. ISSN: 00207683. DOI: 10.1016/j.ijsolstr.2012.08.008. URL: <http://dx.doi.org/10.1016/j.ijsolstr.2012.08.008>.
- Velimirović, L. S., M. S. Ćirić, and N. M. Velimirović (2011). On the Willmore energy of shells under infinitesimal deformations. *Computers & Mathematics with Applications* **61.11**, 3181–3190.
- Villard, d. H. et al. (1859). *Facsimile of the sketch-book of Wilars de Honecort, an architect of the thirteenth century : illustrated by commentaries and descriptions*. London: John Henry and James Parker. URL: <https://hdl.handle.net/2027/gri.ark:/13960/t87h41r7h>.
- Violet-le-Duc, E. (1856). *Dictionnaire raisonné de l'architecture française du XIe au XVIe siècle*. Vol. 4. URL: <https://archive.org/details/dictionnairerais04byuviol>.
- (1875). *Dictionnaire raisonné de l'architecture française du XIe au XVIe siècle*. Paris : A. Morel. URL: <https://archive.org/details/raisonnedelarchi01viol>.
- Vitruvius (1914). *Vitruvius : the ten books on architecture*. Trans. by M. H. Morgan. Cambridge : Harvard university Press. URL: <https://archive.org/details/vitruviustenbook00vitruoft>.
- Walker, D. and B. Addis (1997). *Happold: The Confidence to Build*. Happold Trust Publications Limited. ISBN: 0419240705.
- Watson, J. D. (1968/2010). *The Double Helix: A Personal Account of the Discovery of the Structure of DNA*. (Original work published 1968). Orion Publishing Co. ISBN: 978-0753828434.
- Williams, C. and A. McRobie (2016). Graphic statics using discontinuous Airy stress functions. *International Journal of Space Structures* **31.2-4**, 121–134. ISSN: 20598033. DOI: 10.1177/0266351116660794.
- Williams, C. J. K. (1986). “Defining and designing curved flexible tensile surface structures”. *The mathematics of surfaces*. Ed. by G. J.A. Oxford: Clarendon Press. Chap. 8.
- (1980). “Form finding and cutting patterns for air-supported structures”. *Air-supported structures: the state of the art*. London: The Institution of Structural Engineers, pp. 99–120.
- (1987). Use of structural analogy in generation of smooth surfaces for engineering purposes. *Computer-Aided Design* **19.6**, 310–322.
- (2014). “What is a shell?” *Shell Structures for Architecture: Form Finding and Optimization*. Ed. by S. Adriaenssens, P. Block, and C. J. Williams. Routledge, pp. 21–31.
- Willis, R. (1842). On the Construction of the Vaults of the Middle Ages. *Transactions of the Royal Institute of British Architects*, 1–69.
- Wilson, F. R. (1998). *The Hand - How Its Use Shapes the Brain, Language and Human Culture*. New York: Vintage Books. ISBN: 0-679-41249-2.

- Winslow, P., S. Pellegrino, and S. Sharma (2008). Mapping two-way grids onto free-form surfaces. *Journal of the International Association for Shell and Spatial Structures* **49**, 123–130.
- Wissler, C. (1917). *The American Indian; an introduction to the anthropology of the New World*. New York: D.C. McMurtree.
- Woldeyes, Y. (2018). Preliminary Report: Conservation Concerns for the Lalibela Rock Hewn Churches. December. URL: <https://espace.curtin.edu.au/bitstream/handle/20.500.11937/75855/76057.pdf?sequence=2%7B%5C%7DisAllowed=y>.
- Wolfe, W. (1921). *Graphical analysis; a text book on graphic statics*. New York McGraw-Hill. URL: <https://archive.org/details/graphicalanalysisi00wolf>.
- Yarker, J. (1909). *The arcane schools : a review of their origin and antiquity; with a general history of Freemasonry and its relation to the theosophic, scientific, and philosophic mysteries*. Belfast : W. Tait, p. 596. URL: <https://archive.org/details/b24886002>.
- Zalewski, W. and E. Allen (1998). *Shaping structures : statics*. John Wiley. ISBN: 0471169684.

