



## **Influence of system operation on the design and performance of a direct ground-coupled cooling system**

Downloaded from: <https://research.chalmers.se>, 2026-04-04 18:40 UTC

Citation for the original published paper (version of record):

Arghand, T., Javed, S., Trüschel, A. et al (2021). Influence of system operation on the design and performance of a direct ground-coupled cooling system. *Energy and Buildings*, 234. <http://dx.doi.org/10.1016/j.enbuild.2020.110709>

N.B. When citing this work, cite the original published paper.

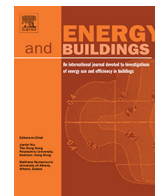

# Influence of system operation on the design and performance of a direct ground-coupled cooling system



Taha Arghand\*, Saqib Javed, Anders Trüschel, Jan-Olof Dalenbäck

Division of Building Services Engineering, Department of Architecture and Civil Engineering, Chalmers University of Technology, 412 96 Gothenburg, Sweden

## ARTICLE INFO

### Article history:

Received 16 June 2020

Revised 13 November 2020

Accepted 29 December 2020

Available online 31 December 2020

### Keywords:

Direct ground cooling

Borehole heat exchanger

Peak shaving

Active chilled beam

Borehole sizing

Borehole fluid temperature

## ABSTRACT

Sizing of borehole heat exchangers (BHEs) for direct ground cooling systems (DGCSs) is a critical part of the overall system design. This study investigates the thermal performance and sizing of a DGCS with two different operation strategies using experimental and simulation approaches. The traditional on/off operation strategy keeps a constant room temperature. The continuous operation strategy has the potential to reduce the building peak cooling loads by precooling the space and having a variable room temperature measures. The experimental results from the laboratory-scale setup show the differences in the hourly room heat extraction rates and the room temperature pattern for the operation strategies applied. The experimental data is also used to develop a simulation model. The simulation results show that applying the continuous strategy reduces the building peak cooling loads and lowers the heat injection rates to the ground. For new BHEs, applying the continuous strategy can result in shorter BHEs, owing to the significantly lower ground heat injection rates. For existing BHEs, applying the continuous strategy can decrease the borehole outlet fluid temperature and thus, increase the cooling capacity of the building cooling system. The findings of this study have implications for developing the widespread use of DGCSs.

© 2020 The Author(s). Published by Elsevier B.V. This is an open access article under the CC BY license (<http://creativecommons.org/licenses/by/4.0/>).

## 1. Introduction

Comfort cooling in buildings is to a large extent based on the use of electricity. Direct ground cooling system (DGCS) (also known as passive cooling or occasionally as free cooling), on the other hand, provides cooling by means of circulating the working fluid through ground heat exchangers, i.e. an array of pipes inserted vertically in the ground. Since this system does not use any refrigeration cycle, only a modest amount of electrical energy is required to run the circulation pumps. Therefore, the energy performance of such a system, defined as the proportion of cooling energy provided by the system to the electricity purchased, has been reported as high as 13–25 [1,2].

One of the main aspects of designing a DGCS is to keep the borehole outlet fluid temperature below a certain level to ensure that enough cooling capacity is available for the building cooling system. Hourly variations in the borehole outlet temperature are influenced by building cooling loads. Rapid increases in building loads would cause an increase in the borehole outlet temperature, since the ground heat transfer rate is slow, owing to its long time constant. Therefore, it is beneficial to reduce the intensity and

duration of building peak loads by applying peak shaving measures.

Generally speaking, peak shaving measures aim at reducing the on-peak electrical demand, utility costs and size of cooling systems by utilising building thermal storage [3,4]. For thermal conditioning of spaces, two common methods for reducing building peak cooling loads are precooling the building structure and applying variable room temperature setpoints [4,5]. Under the pre-cooling method, building structural components and thermal mass are cooled during the off-peak period. The cooled thermal mass absorbs heat during the on-peak period and reduces the peak cooling load. Such a system allows a reduced cooling power since the maximum heat extraction rate is reduced [6,7]. The variable room temperature setpoints method is based on the fact that building energy use and peak loads in building cooling applications are inversely related to the space setpoint temperature. Various studies have reported this approach to have beneficial effects on reducing building energy use [8–10] and building peak loads [11,12].

This study hypothesises that reducing building cooling peaks will reduce the ground peak loads and consequently reduce the borehole maximum outlet fluid temperature (for installed boreholes) or the borehole depth (for under-designed boreholes). This hypothesis is based on previous studies on heat transfer rates of vertical boreholes under fluctuating thermal loads [13–15].

\* Corresponding author.

E-mail address: [arghand@chalmers.se](mailto:arghand@chalmers.se) (T. Arghand).

Typically, in ground heat exchanger design software, such as GLHE-PRO and EED, ground loads are presented as monthly average loads and peak loads to calculate borehole depths. The peak loads are estimated as rectangular pulses with a specified intensity and duration. It has been demonstrated that though the energy content of the peak pulse may not have a lasting effect on the long-term thermal behaviour of the borehole, it highly influences the design exit temperature of the borehole fluid. In other words, the immediate short-term thermal history of heat extractions/rejections by the building peak loads can have a higher impact on the highest borehole outlet temperature than its long-term thermal history [16,17]. Therefore, shaving of building peak cooling loads can reduce the maximum borehole outlet temperature for existing borehole systems or can reduce the required ground heat exchangers' depth for designing new borehole systems.

Only a few studies have been conducted to evaluate the influence of the peak shaving measures on the direct ground-coupled systems. Romani et al. [18,19] adopted a night cooling control approach to a ground-coupled wall cooling system. The study used a two-level room temperature setpoint controller to reduce the ground loads by allowing the room temperature to increase. In the same context, a study by Arghand et al. [20] showed the importance of the room setpoint temperature on the required borehole length and the borehole outlet temperature levels. Other studies by Li et al. [21] and Lyu et al. [22] addressed the advantages of shifting/shaving building peak loads through using a pipe-embedded wall cooling system. However, the influence of reducing building peak loads on the ground loads and sizing the borehole has not been investigated in the previous studies.

To assess this hypothesis, this study investigates a cooling strategy using peak shaving measures to operate a direct ground-coupled active chilled beam cooling system. The objective is to demonstrate the influence of reducing building peak cooling loads on the ground loads and outlet fluid temperature. In order to justify the hypothesis, we study the performance of the cooling system with regard to room temperature, ground loads, ground temperature and system electricity demand, and compare it with a conventional cooling strategy based on strict feedback control.

## 2. Strategies for reducing building peak loads

This section overviews the heat extraction rates in buildings in relation to the cooling strategies used in this study. Details of the cooling strategies will be presented in Section 4.2.

The cooling strategies used in this study adjust the cooling capacity of active chilled beams (ACBs) differently, which in turn influences the heat extraction rates from the building and heat

rejection rates to the borehole. Fig. 1 shows the dynamic space heat extraction rates of a space with two control strategies. The first control strategy (A) is based on a feedback controller keeping the room temperature within the prescribed temperature range by regulating the cooling capacity of room terminal units during the room's occupied hours. As a result, a large-sized cooling system capable of handling short but intense building cooling loads is needed to maintain thermal comfort during the peak periods.

The second cooling control strategy (B) is based on continuous cooling (24 h) and allowing a variable room temperature. Extending the cooling period over the off-peak period enables utilising the building thermal capacity for precooling. This reduces the required building peak heat extraction rate and the ground loads. The cooling method also allows the room temperature to rise during the peak load periods, which in turn reduces the heat extraction rate from the space. The water flow rate and temperature in this system shall be designed to keep the room temperature within the thermal comfort criteria.

The comparison between the two control strategies is designed so that the total amount of heat extracted from the building and rejected to the ground during the cooling season is similar for both cooling methods used in this article. This is because the ground temperature change over the long run is dependent on the total amount of heat extracted from or rejected to the ground in a given time [23]. Thus, the building cooling energy over the cooling season is kept similar for the cases studied. In addition, the direct ground cooling system considered in this article is a thermally balanced ground-coupled system where the annual ground temperature increase is insignificant. In an imbalanced system, the ground temperature change gradually degrades the thermal performance of the ground-coupled system [24,25].

## 3. Model development and validation

We developed a simulation model of a direct ground-coupled cooling system to study the thermal behaviour of the cooling system and the borehole system during the cooling season of 4.5 months. The model was developed based on laboratory experiments and also has been validated against experimental results. The experimental results are also used to explain the hourly heat extraction rates from the test room and the subsequent room temperature.

The experimental part of this section presents the experimental facility and conditions for which the cooling system is tested. The main emphasis is to introduce the two cooling control strategies and show the heat extraction rates from the room with those strategies. The model development section (Section 3.2) explains

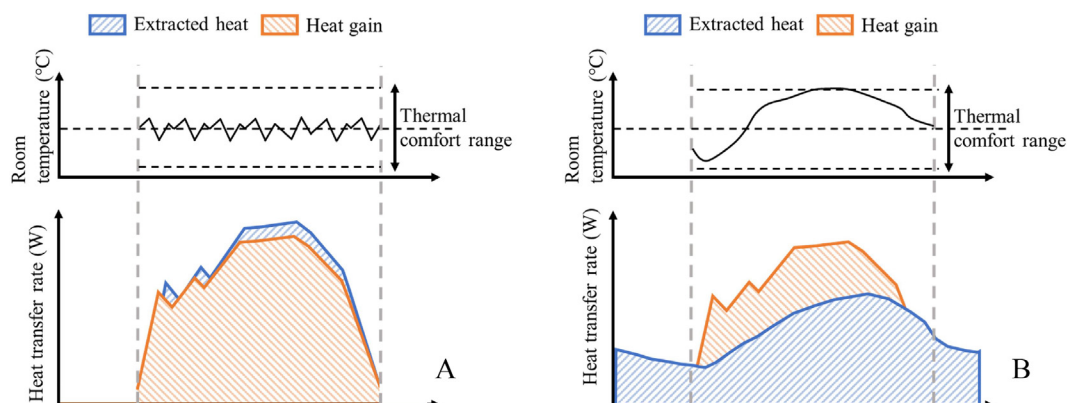

Fig. 1. Conceptual example of heat extraction rates by the cooling strategies evaluated in this article. A) Typical feedback control method to keep the room temperature constant during its occupied hours, B) Continuous cooling (24-hours) and variable room temperature.

the methodology and assumptions used to simulate the laboratory cooling system. Model validation with the experimental results is shown at the end of this section.

### 3.1. Methodology for experimental validation

#### 3.1.1. Experimental facility

The experiments of this study were carried out in a test room resembling a typical single-unit office for one or two occupants. The test room was 12.6 m<sup>2</sup> large (4.2 l × 3.0 W) and had a ceiling of 2.4 m high. The walls were 0.112 m thick and were made up of expanded polystyrene panels finished with gypsum board panels. The test room was in a lab hall and was therefore protected not only from the direct sun radiation but also from the outdoor temperature. The test room was also thermally insulated from the ground using a 30 mm expanded polystyrene sheets and 6 mm of plasterboard with a layer of 22 mm fibreboard on top.

Heat sources in the test room were designed to simulate internal and external heat gains in a typical single-office room. The heat gain sources were electric foil heaters on a wall and ceiling, a thermal dummy and lights, see Fig. 2. To simulate a periodic heat gain condition in the test room, heat gain from the sources was set as either 90 W or 420 W (8.5 W/m<sup>2</sup> or 33.5 W/m<sup>2</sup>).

The test room was cooled by an active chilled beam (ACB) system. ACBs are integrated convective-based room terminal units comprised of a hydronic part and a ventilation part. The main cooling medium is high-temperature chilled water, but air also enhances the cooling capacity of the beam if it is supplied at a temperature below the room air temperature. However, our assessment assumed that the room cooling load was only removed by water since the supply air to the ACB was provided at a room-neutral temperature by recirculating the room air.

High-temperature chilled water to the cooling system was provided through a single U-tube borehole system. The borehole was drilled as close as possible to the experimental facility at the campus of the Chalmers University of Technology in Gothenburg, Sweden. The borehole had an active depth of 80 m and was naturally filled with groundwater, as is common in Sweden [26]. Table 1 summarises borehole parameters and local geological characteristics of the ground. More details about the borehole can be found in [27,28].

Fig. 3 shows an overview of the cooling system, including the borehole, the pipework and control system, and the ACB. The cooling loop was divided into three parts: the ground loop, the middle

**Table 1**  
Ground and borehole system specifications [29].

Parameter (unit)	Specification
<b>Borehole</b>	
Active depth (m)	80
Diameter (mm)	110
Filling material	Groundwater
Thermal resistance (m.K/W)	0.059
Undisturbed ground temperature (°C)	8.3
Soil thermal conductivity (W/m.K)	2.88
<b>U-tube</b>	
Pipe type (-)	Polyethylene, PN8 DN40
Inner diameter (mm)	35.4
Outer diameter (mm)	40.0
Thermal conductivity (W/m.K)	0.42
<b>Circulating fluid</b>	
Type	Ethanol (29.5%)
Thermal conductivity (W/m.K)	0.401
Specific heat capacity (J/kg.K)	4180

loop and the building loop. The loops were connected through heat exchangers. Control valves and pumps in the intermediate and the building loops were connected to a control system to regulate the water flow, if needed. The circulating pump in the ground loop operated to provide a constant turbulent flow condition in the borehole tubes. The operating sequence of the valves and pumps is explained in Section 3.1.2.

The supply and return water temperatures of the ACB and the inlet and outlet fluid temperatures of the borehole were measured using PT-100 screw-in type temperature sensors. The accuracy (bias) of all the PT – 100 thermometers was (0.1 + 0.0017 × measured value) °C. The room air temperature was measured with a probe-type PT-100 sensor placed 1.10 m above the floor, see Fig. 3. A similar sensor was also used to measure the room’s operative temperature. The measuring section of the probe was placed inside a 4.0 cm grey Ping-Pong ball to measure the combined effects of air temperature and mean radiation temperature, in accordance with the findings of Simone et al. [30]. The sensors were calibrated before starting to take measurements.

Water flow measurements were carried out using vortex-type flow meters. The flow meters are shown in Fig. 3. The flow meters had an accuracy of ± 1.5% of the full scale (20 l/min) and a resolution of about 0.2 l/min.

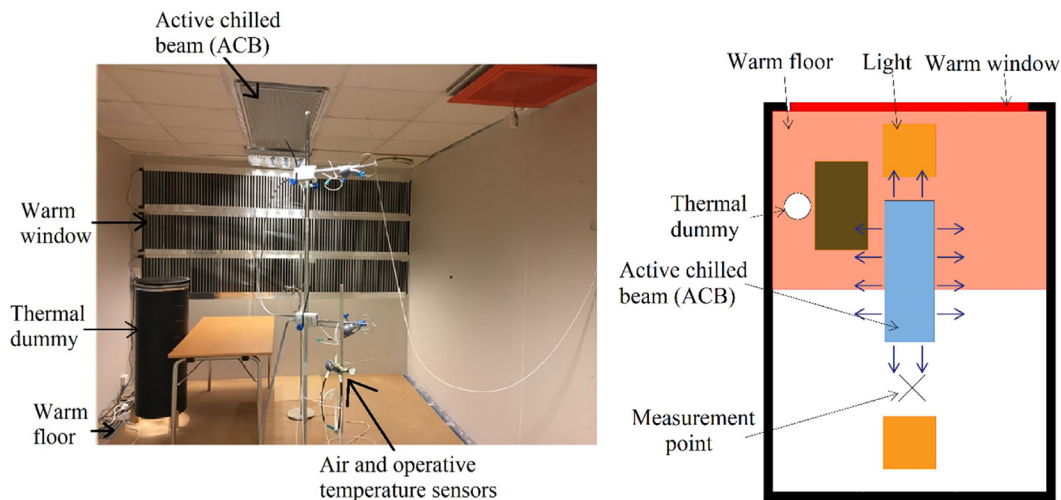

**Fig. 2.** A) Picture of the experimental setup, and B) test-room layout.

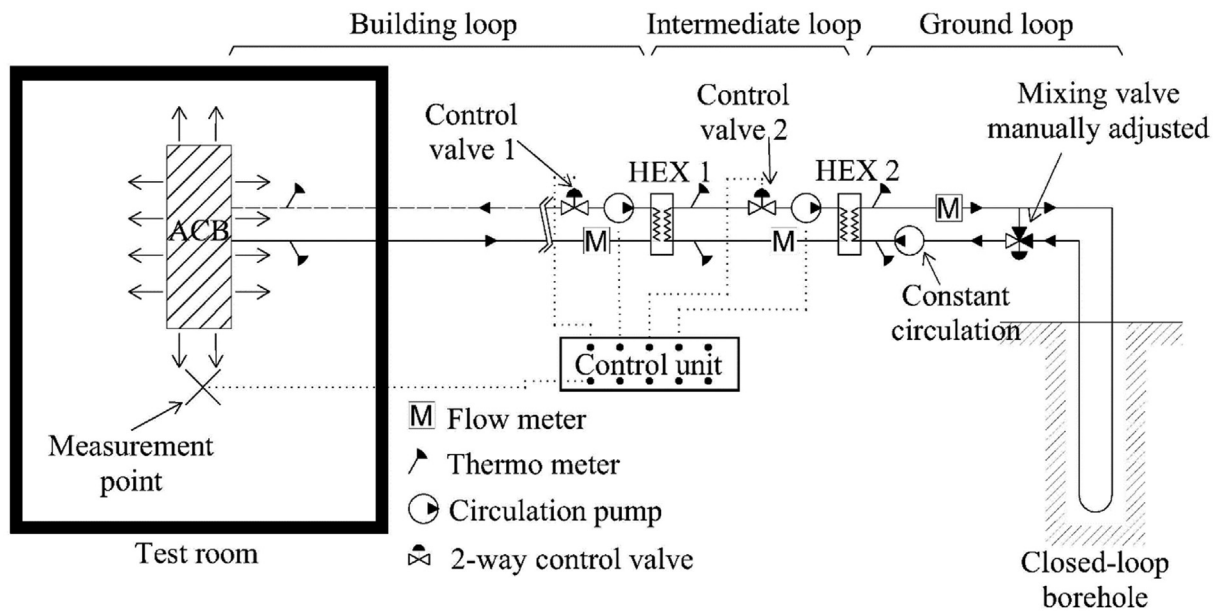

Fig. 3. Schematic of the test room and the control system.

3.1.2. Experimental condition

The main objective of the experimental study is to compare the room temperature and cooling capacity of the ACB controlled by two control strategies, namely intermittent and continuous. The intermittent control strategy included a feedback controller to maintain the room air temperature at 23 °C. The continuous cooling operation strategy provided continuous cooling for the space and the room temperature changed with heat-load intensity variations. The experiments were carried out under a periodic heat gain condition. Although the duration of the experiments was limited to 4 h, outcomes are still helpful to comprehend the thermal behaviour of the cooling system during its daily operation.

The intermittent cooling strategy used a feedback controller to keep the room temperature within a prescribed temperature range by adjusting the ACB's cooling capacity. This cooling control strategy was implemented using a two-way control valve, denoted as "control valve 1" in the building loop in Fig. 3.

To implement the continuous cooling operation strategy, the water flow rate to the ACB was kept constant and the corresponding control valve in the building loop was kept open. However, the control valve in the intermediate loop, denoted as "control valve 1" in Fig. 3, was regulated to keep the supply water temperature at the ACB constant. Note that the supply water temperature with continuous operation strategy was 1 °C higher than that with the intermittent method. The lower water temperature reduced the cooling capacity of the ACB. However, the total amount of heat taken away from the room was similar for one low and high heat gain cycle. Table 2 summarises the input parameters of the cooling system.

To simulate a transient thermal condition in rooms due to changes in heat gains, the heat sources in the room were operated periodically. The low and high heat gain levels of 90 W (8.0 W/m<sup>2</sup>) and 420 W (33.5 W/m<sup>2</sup>), respectively, were operated for 120 min each. It is worth mentioning that for each experiment, the borehole outlet temperature and the ACB supply water temperature were kept constant. Variations in the supply temperatures would have changed the cooling capacity, and, in turn, the rate of heat extraction from the space.

Table 2

Experimental supply parameters for the laboratory cooling system.

Operation strategy	Intermittent	Continuous
ACB's cooling capacity control method	On/off supply water flow rate	Constant water flow rate and constant supply water temperature
Primary air temperature (°C)	Similar to room temperature	Similar to room temperature
Primary air flow rate (l/s)	25.2 ± 0.1	25.0 ± 0.1
Supply water flow rate (l/min)	0/5.6 ± 0.2	5.6 ± 0.3
Supply water temperature (°C)	19.8 ± 0.4	20.8 ± 0.1
Borehole outlet temperature (°C)	11.3 ± 0.1	11.6 ± 0.0

3.1.3. Experimental results

Fig. 4 shows room heat extraction rates by ACB as calculated based on the measured water flow rate and the measured temperature difference between the supply and return water of the coil. Fig. 5 shows the measured temperature in the test room under the intermittent and continuous operation strategies. Heat gains [32] shown in Figs. 4 and 5 represent the consumed electrical

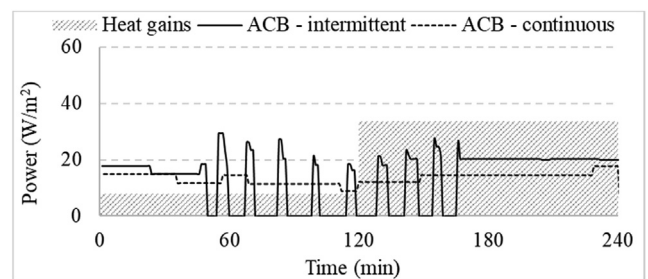
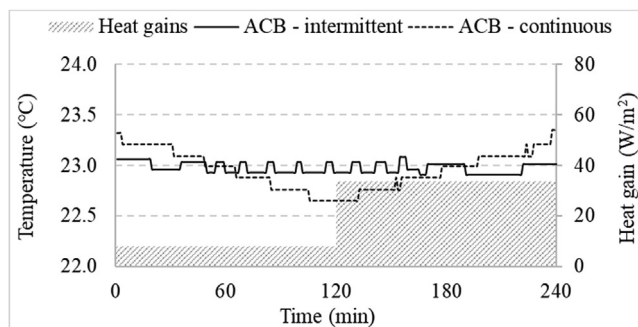

Fig. 4. Room heat extraction rate by ACB with continuous and intermittent operation strategies. The heat extraction rates are calculated based on the difference between the supply and return water temperatures obtained from the laboratory experiments. Heat gain refers to the consumed electrical power of the heat sources in the room.



**Fig. 5.** Experimental room temperature with the intermittent and the continuous operation strategies. Heat gain refers to the consumed electrical power of the heat sources in the room.

power of the heat sources in the room. However, there exists a lag between the measured heat gain and the actual heat released to the room. The lag is mainly due to the thermal mass of the heat sources, particularly the warm structural elements, and partly due to the radiant heat. Moreover, some part of the heat gains is lost through room envelope and infiltration. Consequently, the cooling power needed to keep the room temperature at a constant temperature differs from the room heat gains as seen in Figs. 4 and 5.

The heat extraction rate with the intermittent control strategy represents an interrupted pattern, as the control valve adjusts the cooling capacity of the beam by controlling the water flow intermittently. The control system aims at keeping the room temperature constant at 23 °C. During the low heat gain period, the time interval between opening and closing the control valve gets longer by the end of the low heat gain period, since the room cooling load decreases. This can be seen in both the intensity and duration of the heat removed from the space (Fig. 4). If the room cooling load is not high enough to increase the room temperature above 23 °C, the control valve stays shut and no heat is removed from the room. With the continuous control strategy, the ACB is supplied with constant water flow at a constant temperature (about 21 °C), resulting in continuous heat extraction from the room.

There is some discrepancy between the heat production by the sources and heat extraction by the ACB. The magnitude varies over time, as the experiment is performed under a transient heat gain condition. However, under the steady-state condition, the heat losses are estimated to be 130 – 140 W. The major part (~ 110 W) is due to the thermal transmission through the test room envelope. A small part (~ 20 W) is due to infiltration losses. An even smaller part (~ 5 – 10 W) is due to ventilation losses.

An uncertainty analysis is performed to estimate the impact of multiple uncertainties on the experimental study. Measurement uncertainties are estimated as the root sum of the squares of the uncertainties due to the systematic errors. Systematic errors usually originate in measurement instruments, and experimental setup, etc. Uncertainties in the calculated ACB cooling capacity are due to uncertainties in water temperature and water flow measurements. The uncertainties in water density and specific heat are negligible [31]. Based on the thermometers' accuracy of  $\pm 0.1$  °C, and the temperature difference across the ACB of about 0.7 K, the uncertainty in the temperature measurements can be estimated to be  $\pm 20\%$ . The uncertainty in flow measurements is about  $\pm 5\%$ . Thus, the uncertainty of the ACB cooling capacity calculations is estimated to be  $\pm 20\%$ .

It is necessary to mention that the differences in the heat extraction rates shown in Fig. 4 are not large. This is mainly due to short periods of low and high heat gains, the low thermal mass of the room structure and furniture, and a low-intensity heat gain

pulse. In practice, external heat gain from solar radiation would cause a considerable difference between the heat extraction rates when using the intermittent and continuous strategies.

Fig. 5 shows the room temperatures recorded in the test room under both the intermittent and the continuous strategies. Room temperature with the intermittent control strategy was constant at the setpoint of 23 °C during the low and high heat gain condition. Small overshoots or undershoots are mainly due to the on/off flow rate of the water into the coil. However, the continuous control strategy results in a varying room temperature of about  $\pm 0.7$  K. This variation would be even greater if the high heat gain period were longer and/or its intensity was greater. In practice, this condition arises in the presence of intense solar radiation or when there is a drastic change in a room's occupancy rate.

Figs. 4 and 5 show a similar trend in changes in room temperature and the heat extraction rate with the continuous strategy. The heat extraction rate from space is directly proportional to the difference between the room temperature and the coil mean water temperature. A higher room cooling load, due to the increase of the heat gain, causes the room temperature to rise, which, in turn, increases the heat extraction rate from the space. The opposite pattern can be seen during the low heat gain period. Therefore, in order to define the amplitude of the variation of the room temperature with the continuous operation strategy, the water temperature and flow rate should be designed in relation to the minimum and the maximum cooling loads of the room.

The experimental results presented in this section compare the heat extraction rate and room temperature under the continuous control strategy and the intermittent control strategy. Section 3.2 shows the application of these control strategies for operating the ground-coupled system.

### 3.2. Model development

The simulation presented in this article was carried out using the building performance simulation software IDA ICE version 4.8. This software has been validated against measurements under the framework of various standards, including CIBSE TM33 [33], ANSI/ASHRAE 140 [34] and EN 13791[35]. In addition, the model developed in IDA for this study was validated against the experimental data acquired from the tests outlined in Section 3.1.

The model of the cooling system consists of two main parts: the test room model and the borehole system model. The room model involves simulating the heat transfer processes of the room and the cooling system. Input parameters of the cooling system and the control system were taken from the experimental study. Input parameters regarding thermal characteristics of the heat sources, e.g. convective heat fraction of the lighting and building material thermal characteristics, e.g. U-value and density, have been taken from literature and adapted to the model to bring its predictions in line with the experimental observations.

The main input data used for modelling the perimeter of the test room and the ACB system is summarised in Table 3. The IDA ICE model used the same construction material as the test room. The heat sources in the room were simulated using electric foil heaters and lighting. The convective heat fraction of the recessed fluorescent luminaire lighting was taken 0.3, according to [36]. The exterior side of the internal walls was exposed to the spaces with an air temperature of 20.5 °C, equal to the exterior air temperature of the test room in the experimental setup.

The ACB model in IDA ICE 4.8 consists of two sub-models for simulating the hydronic and the ventilation parts of the ACB. The hydronic part of the model calculated the cooling capacity of the water circuit based on the water flow rate and the logarithmic difference between the mean coil water temperature and the room air temperature. As in experiments outlined in Section 3.1.2, the water

**Table 3**  
Simulation input data for validating the DGCS for the test-room model.

Parameter (unit)	
<b>Perimeter</b>	
Wall thickness (m)	0.11
Wall U-value (W/m <sup>2</sup> .K)	0.33
Ceiling U-value (W/m <sup>2</sup> .K)	0.62
<b>Active chilled beam</b>	
Design cooling capacity (W)	810
Primary airflow rate (l/s)	25
Primary air temperature (°C)	Room temperature
Exhaust airflow rate (l/s)	25
Supply water flow rate (l/min)	5.6
Supply water temperature (°C)	19.9 (intermittent strategy) 21.0 (continuous strategy)
ACB cooling capacity control method	On/off water flow rate (intermittent strategy) Supply water temperature (continuous strategy)

flow rate in the ACB was constant with the continuous strategy and intermittent with the intermittent strategy. The main input data used for the ACB simulation is summarised in Table 3.

The IDA ICE borehole model utilises a finite difference technique and superposition to calculate several temperature fields which altogether generated a 3-D temperature field around the borehole [37]. The following temperature fields were modelled and simulated for each borehole [38]:

- 1-D vertical heat transfer model for the heat carrier fluid circulating through the U-tube
- 1-D heat transfer model for borehole filling material computing heat exchange rates between the borehole filling material with the surrounding ground and the liquid inside the U-tube
- 2-D heat transfer model in cylindrical coordinates around the U-tube to simulate the heat exchange rates between the U-tube and the borehole filling material

In addition, the borehole model makes some assumptions, including uniform vertical temperature and geological structure for the surrounding ground, the constant thermal resistance of the borehole and the insignificant influence of vertical and horizontal groundwater flow.

In this study, the input design parameters for the borehole model are similar to the experimental data shown in Table 1.

### 3.3. Validation results

Validation of the model, carried out by comparing its output with the room air temperature, is described in this section. The simulation condition was a periodic heat gain condition, as described in Section 3.1.2.

Fig. 6 shows that the model performs well for simulation of the heat transfer in the room. The simulated room temperature with the intermittent and the continuous strategies deviated only ± 0.1 K from the actual room temperature. The small discrepancy between the experimental and simulation results was due to the difference in the actual and simulated heat gains in the room, as previously discussed in Section 3.1.3. However, it did not have much influence on the results of the energy simulations.

## 4. Extended simulation model and results

Development and verification of the model introduced in Section 3.2 aimed at simulating heat transfer rates in the test room and the borehole system based on the given experimental results. In this section, we extend the model of the laboratory cooling system to include the effect of solar radiation for an open-plan office

on a realistic scale. We describe the extended model in the following section.

### 4.1. Extended simulation model

The simulated office zone consisted of an open-plan office on the first floor of a building facing south. The office was 88.7 m<sup>2</sup> large and exchanged heat with outside through three external walls and a floor. Windows with a total area of 12.6 m<sup>2</sup> (window to wall ratio of 33%) were on the southern wall, and no internal or external shading was applied (see Fig. 7). The input parameters of the extended model can be found in Table 4.

The internal heat gain sources included occupants, lights and office equipment, which altogether generated 22 W/m<sup>2</sup> of internal heat during the period from 6:00 to 18:00 on weekdays. Thermal characteristics of the lights and the electrical equipment, such as the convective fraction of heat gains for lights and long-wave radiation fraction of the equipment, were kept unchanged from the

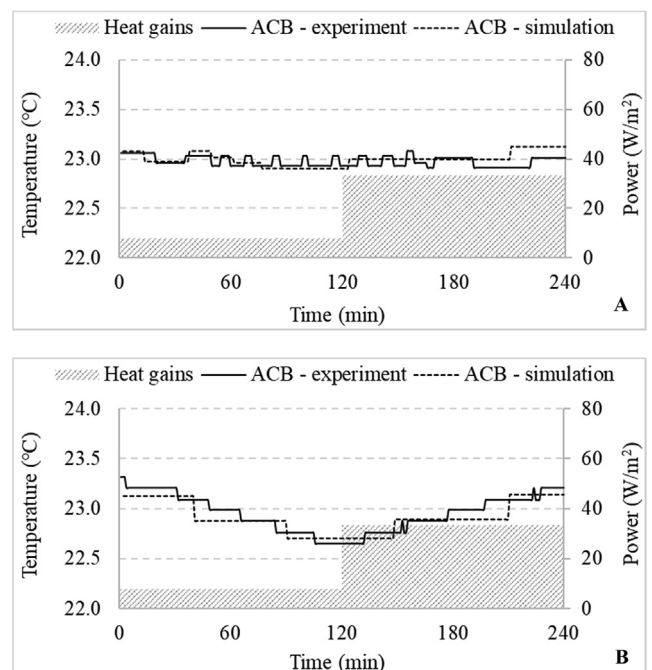

**Fig. 6.** Measurement data and simulation results on the room air temperature with A) the intermittent operation strategy and B) the continuous operation strategy. Heat gain refers to the consumed electrical power of the heat sources in the room.

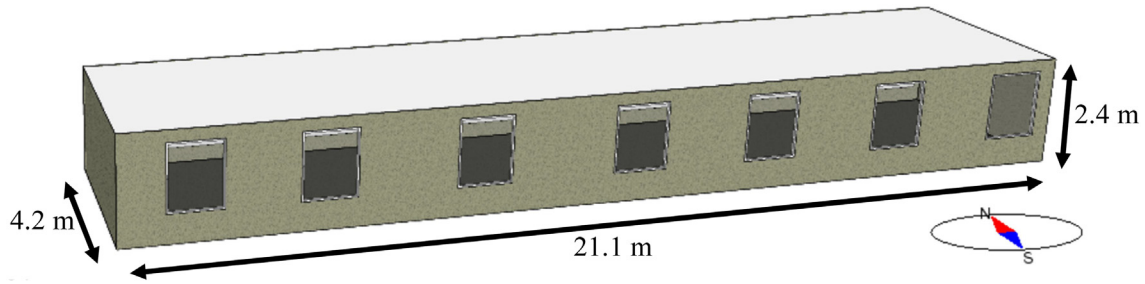

Fig. 7. Plan view of single-perimeter zone of an office building.

**Table 4**  
Description of the input parameters of the extended simulation model.

Parameter (unit)	
<b>External walls</b>	
Dimensions (m)	21.1 × 2.4, 4.2 × 2.4 (W × H)
U-value (W/m <sup>2</sup> .K)	0.33
Thickness (m)	0.27
<b>Internal walls</b>	
Dimensions (m)	21.1 × 2.4 (W × H)
U-value (W/m <sup>2</sup> .K)	0.54
Thickness (m)	0.11
<b>Windows</b>	
Number of windows	7
Dimensions (m)	1.5 × 1.2 (H × W)
U-value (W/m <sup>2</sup> .K)	1.19
G-value (%)	43
<b>Borehole</b>	
Depth (m)	200
BHE fluid mass flow rate (kg/s)	1.5
Other specifications	See Table 1
<b>Active chilled beams</b>	
Number of ACBs	7
Primary airflow rate	Variable based on the cooling method, see Table 5
Supply water temperature (°C)	Variable based on the cooling method, see Table 5
Other specifications	See Table 3

test-room model. The simulated office is located in Gothenburg, Sweden, and the simulation period was from 14 May 2018 to 22 September 2018.

Ground geological thermal properties and borehole thermal characteristics in the extended model were similar to the original model with the exception of the borehole active depth and fluid flow through the borehole loop. A deeper borehole and larger borehole flows were considered to ensure that the borehole system could provide enough cooling capacity for the building cooling system.

**Table 5**  
Cooling methods and main input design parameters of the cooling system in the simulation model.

Operation strategy		Intermittent operation	Continuous operation
Operating hours	6:00–19:00	24 h	
System specifications during working hours (6:00–18:00)	Primary airflow rate (l/s.m <sup>2</sup> )	2	2
	Supply water temperature (°C)	16	19.5
	Circulating water flow rate (l/s)	0 / 0.5	0.5
	Pump/Fan status	on / on	on / on
System specifications during non-working hours (18:00–06:00)	Primary airflow rate (l/s.m <sup>2</sup> )	0	0
	Supply water temperature (°C)	–	16
	Circulating water flow rate (l/s)	0	0.5
	Pump/Fan status	off / off	on / off

#### 4.2. Operational strategies of the cooling system

The simulation model was operated with either intermittent or continuous cooling control strategies to assess the thermal performance of the ground-coupled ACB system. The cooling system operated only on working days and was off during weekends, regardless of the cooling control strategy. The term ‘working hours’ (6:00–18:00) refers to the period when the staff was present in the office and office equipment was operating. On the other hand, the term ‘operating hours’ specifies the operation period of the cooling system.

The intermittent control strategy operated the ground-coupled ACB system between 6:00 and 19:00. The operation period of the system was one hour longer than the working hours, to ensure that accumulated heat in the zone was removed. The cooling capacity of the ACBs was controlled by the on/off supply water flow controller. In this control strategy, the signal from the room temperature drove the control valves’ actuator intermittently to keep the room temperature at 23.0 °C.

The operational period of the cooling system with the continuous control strategy was 24 h, but its operational parameters differed during working (6:00 – 19:00) and non-working (19:00 – 06:00) hours. The primary airflow rate was only supplied during working hours. During non-working hours, the pumps kept circulating cold water to the beams to cool the space by natural convection. During non-working hours, the supply water temperature to the beams was decreased to 16 °C. Furthermore, during non-working hours, the supply water temperature to the beams was decreased to 16 °C to provide greater cooling capacity. The supply temperature from the borehole was regulated to the desired level using the three-way mixing valve installed in the borehole loop (see Fig. 3). The continuous control strategy enabled the room temperature to vary within the thermal comfort range, as previously explained in Section 2.

Table 5 summarises the operational strategies of the cooling system.

**Table 6**

Main metrics featuring energy performance of the cooling system and the room temperature during the occupied period (06:00–18:00) with the continuous and intermittent cooling operation strategies simulated for the period between 14 May 2018 and 22 September 2018.

Operation strategy	Cooling energy (MWh)	Maximum heat removed (W/m <sup>2</sup> )	Maximum room air temperature (°C)	Minimum room air temperature (°C)
Intermittent	3.21	55.4	23.5	22.9
Continuous	2.58	39.6	25.1	22.3

4.3. Simulation results

The cooling performance and electricity demand of the cooling system were simulated for the period between 14 May 2018 and 22 September 2018. Total cooling extracted from the ground was  $3.57 \pm 0.01$  MWh for both cases studied. This is especially important when it comes to investigating the long-term ground temperature change since the ground temperature over the long term changes depending upon net heat extracted from or rejected to the ground.

4.4. Ground loads

Table 6 provides valuable information about the cooling system’s energy use and the temperature level of the simulated office during its occupied hours. With the intermittent control strategy, approximately 90% of the total cooling energy, i.e. 3.21 MWh out of 3.57 MWh, needs to be provided during the occupied hours by the borehole system. On the other hand, only 72% of the total cooling energy has to be provided during the occupied hours with the continuous control strategy. The rest of the cooling energy is provided during the non-occupied hours. Given the fact that the total cooling energy is similar for all cases, cooling energy provided by the borehole is distributed over a longer period of the day under the continuous control strategy.

Table 6 also shows the correlation between the maximum room temperature and maximum heat removed from the room. To keep the room temperature constant, a greater amount of heat needs to be removed from the room during the peak period compared to when the room temperature is allowed to increase during the same period. The variable room temperature reduces, to a great extent, the ground loads, as well as the required borehole depth.

Fig. 8 compares the ground loads covered by the borehole during the occupied hours with the two control strategies. The results show that the average value and the peak value of the ground load were significantly higher when using the intermittent rather than the continuous operation strategy. This is because a large amount of cooling must be provided during the 12-hour occupied period when the system operates with the intermittent control strategy. With the continuous cooling operation strategy, the same amount of cooling is extracted over a period of 24 h. Note that the ground

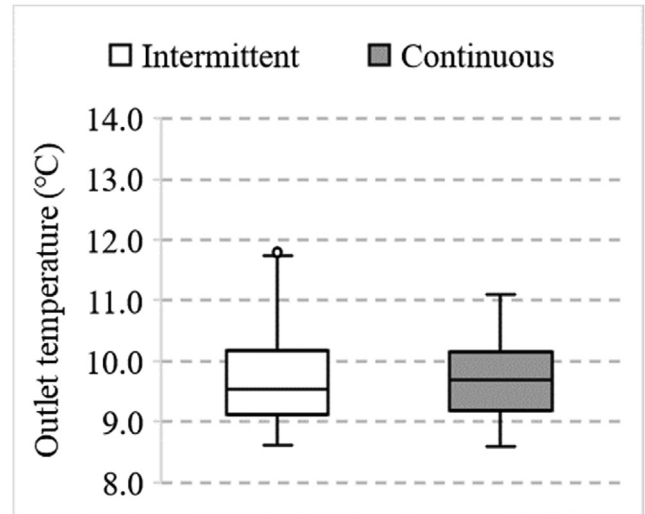

Fig. 9. Borehole outlet fluid temperature during the simulation cooling season between 14 May 2018 and 22 September for the extended office model. The considered undisturbed ground temperature is 8.3 °C.

load during the unoccupied hours (18:00–06:00) was zero with the intermittent strategy, while it was approximately 0.40 kW with the continuous strategy.

The maximum ground load occurred on 29 August 2018, and its intensity was 4.88 kW and 3.51 kW under the intermittent and continuous strategies, respectively. Comparing the peak loads in Fig. 8 shows that sizing the borehole system would substantially benefit from the peak load reduction originated in the combined effect of precooling the space and letting the room temperature increase during the peak loads.

4.5. Borehole outlet temperature

Fig. 9 shows the distribution of the outgoing borehole fluid temperature in the form of boxplots. Each central box of a boxplot presents the interquartile range, with a horizontal line at the median

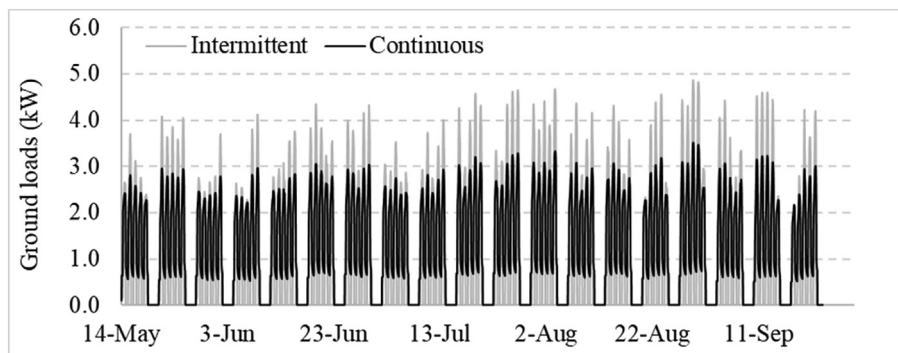

Fig. 8. Ground loads for the extended office model with the intermittent and continuous cooling strategies. The ground loads are calculated based on the fluid flow rate in the borehole and the temperature difference between the borehole inlet and outlet fluid.

and the lower and the upper quartiles representing the 25th and 75th quartiles at the bottom and top of each box. The whiskers define extra quartile values, with the dot symbols representing the outliers, if any. The results present the temperatures for the whole simulation period, including occupied and non-occupied periods and weekends.

The highest borehole outlet temperature in Fig. 9 is 11.9 °C for the intermittent strategy and 11.1 °C for the continuous strategy. The borehole outlet temperature is mainly influenced by the intensity and duration of the building cooling load. The maximum temperatures occurred on the peak cooling day. Given that the duration of the maximum ground load is equal for all cases (see Fig. 8), the peak load intensity majorly influences the borehole outlet temperatures. Therefore, we can conclude that the peak borehole outlet temperature is expected to be lower with the continuous cooling operation strategy.

The lower temperature range of the system, i.e. the interval between the minimum and the first quartile, appears to be similar for both cases. This is important since extending the daily heat injection period to the ground causes a gradual temperature increase in the ground, as previously studied in [39–41]. However, low building cooling loads with the continuous operation strategy likely played the same role in the ground heat recovery as was played by the intermittent heat extraction from the ground with the intermittent control strategy.

4.6. Zone thermal condition and comfort

Since precooling may cause thermal discomfort problems for the occupants, it is crucial to analyse the lowest temperature that appeared during the occupied hours. Room operative temperature is picked to assess the thermal environment, as recommended by ISO 7730 [42], ISO 15251 [43] and ASHRAE 55 [44].

Fig. 10 shows the distribution of the room operative temperature during the occupied period in the form of boxplots. The lowest operative temperatures in the room are 22.8 °C and 22.1 °C for the intermittent and the continuous control strategies, respectively. The lowest temperatures occur early in the morning before the internal heat gains warm up the space. The lower room operative temperature with the continuous strategy is attributed to the pre-

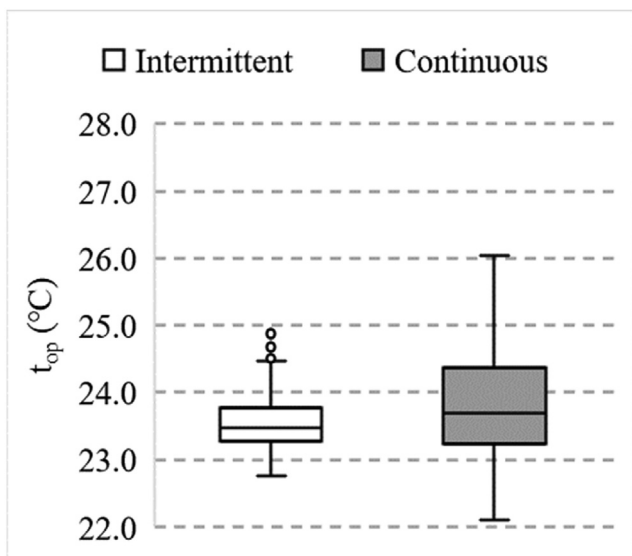

Fig. 10. Room operative temperature ( $t_{op}$ ) during the occupied hours (06:00 to 18:00) with the continuous and intermittent operation strategies simulated for the period between 14 May 2018 and 22 September 2018.

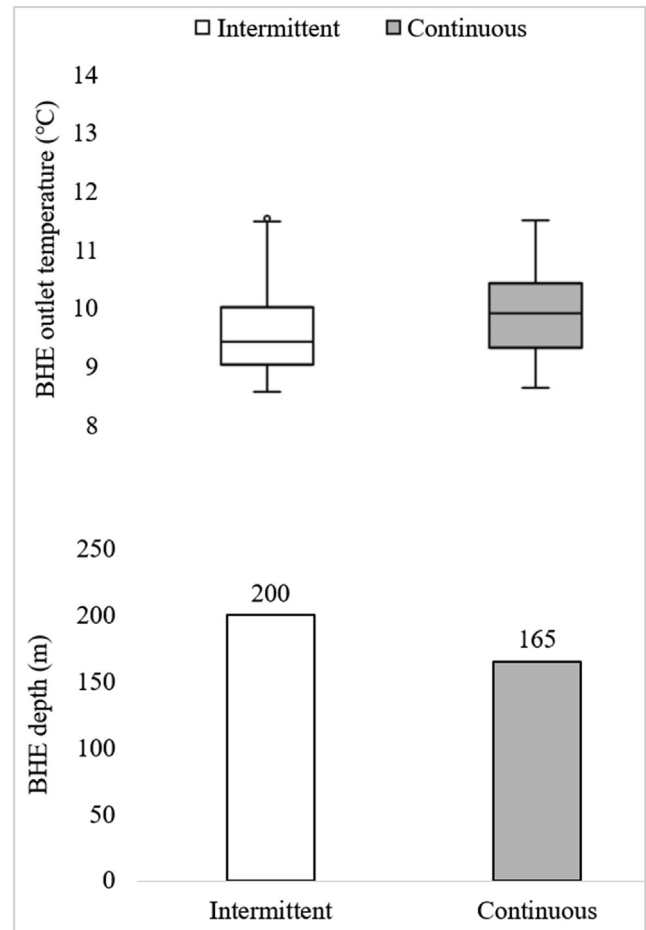

Fig. 11. Modified sizes of the BHE calculated based on the actual heat injection rate to the ground to obtain similar maximum outlet fluid temperature. The undisturbed ground temperature is 8.3 °C.

cooling of the space. It is worthwhile noting that all the operative temperatures are above the minimum required temperature, i.e. 22 °C, to fulfil thermal comfort criteria recommended by ISO 7730 [42].

4.7. Borehole sizing

All the simulation results shown so far apply to existing borehole systems. However, for new systems, BHE sizing shall be performed using the actual ground loads. It is worth restating that the primary assumption, which is keeping the total ground loads constant for both cases, is still valid. The calculation criteria have been to adjust the BHE depth to achieve the same maximum outlet fluid temperature, i.e. 12 °C.

Fig. 11 shows the required BHE depths calculated based on the actual ground loads shown in Fig. 8. The new depth for the continuous operation strategy reduced by approximately 18%, due to the lower ground heat injection rates. The continuous operation strategy extracts heat from the space over a longer period

Table 7  
Electrical energy use of the cooling system with different cooling operation strategies.

Meter	Intermittent (kWh)	Continuous (kWh)
Fans	362.4	362.4
Pumps	159.5	401.2
Total	521.9	763.6

and allows the room temperature to increase during the peak periods. Both the longer heat injection time to the ground and the lower peak intensity are favourable to BHE design since the ground has a long time constant.

#### 4.8. Electrical energy use of the cooling system

Although it is desirable to reduce the building peak cooling loads, electrical energy use and energy efficiency of the system should not be undermined. The electrical energy demand of a direct ground-coupled ACB system consists of the energy use by the circulation pumps and the fans. The cooling control strategies investigated in this study run the pumps and fans differently in terms of their operating period, see Table 5.

Table 7 summarises the electrical energy demand of the system during the period between 14 May 2018 and 22 September 2018. The lowest electrical energy demand is for the intermittent control strategy since it operates the system only during the occupied hours between 6:00 and 19:00. The continuous cooling operation strategy runs the circulation pumps to precool the space all day long. By consulting Table 7 and Fig. 8, it can be seen that applying the continuous operation strategy leads to a 28% reduction (from 4.88 kW to 3.51 kW) in the peak ground load, while the electrical energy use of the system increases by approximately 46% (from 522 to 764 kWh).

## 5. Discussion

The main hypothesis of this study is that applying a control strategy to reduce the building peak cooling load by means of peak shaving measures causes a decrease in the ground loads, required borehole depth and borehole outlet fluid temperature. Using the continuous cooling operation strategy, developed by incorporating variable room temperature and precooling the building, considerably reduces the maximum ground load from 4.88 kW to 3.51 kW. For the existing borehole systems, ground load reduction can decrease the maximum borehole outlet temperature by 0.8 K. For the new borehole systems, ground load reduction results in a decrease in the BHE depth from 200 m to 165 m.

Results from the previous studies by Romani et al. [18,19] and Li et al. [21] showed the influence of applying the peak shaving measures on the thermal performance of DGCSs. Our results confirm the previous findings on the advantages of applying operational strategies to reduce building peak loads. However, the novelty of this study is to associate and quantify the influence of the control strategies for DGCSs on the sizing and dimensioning of BHEs.

Applying the intermittent method yields the lowest electricity demand. However, the difference between the lowest and the highest energy electricity demands over a period of 4.5 months is only about 242 kWh. On the other hand, reduction of the borehole depth due to the peak shaving measures would have a greater pay-off in the drilling cost of the boreholes compared to the financial benefit of saving this much electricity.

One potential concern regarding the application of the continuous operation strategy is local thermal discomfort for the occupants in transient thermal environments due to room temperature fluctuations. Another one is the occurrence of low temperatures in the morning. Thermal receptors in the human body are sensitive to both the magnitude and rate of changes in the surrounding temperature. ASHRAE 55 [44] suggests keeping the operative temperature fluctuations less than 3.3 °C during a 4-hour period to avoid thermal discomfort issues for the room occupants. In our simulations, the temperature drifts in the simulated space were 0.4 °C on the peak cooling day. Regarding the

prevalence of low temperatures in the morning, some recent studies have demonstrated a preference for slightly lower temperatures by occupants in the morning [43] due to the physiological thermal adaptation process of the individuals [44]. The lowest recommended operative temperature is 22.0 °C [39,41,42]. In our simulations, the lowest operative temperature in the room never fell below 22.1 °C. These results imply that the application of continuous operation strategy should not cause comfort problems.

The continuous operation strategy demonstrated in this study is not only easy to implement but it also substantially reduces the number of control valves in the system. This is because this cooling method is applied to a thermal zone, as opposed to the intermittent control strategy in which terminal units are individually controlled by a control valve. One way to implement this method is to use three-way control valves controlled by a modulating controller, such as proportional (P) or proportional-integral (PI) controllers, to keep the supply water temperature constant for a thermal zone. Controlling the supply water temperature is found to be quite an effective method in the thermal conditioning of buildings since the cooling capacity of the terminals is directly proportional to the supply water temperature. The application of this cooling control strategy has been investigated with various terminal units, including thermally activated building systems (TABS) [45], ceiling cooling panels [46] and fan-coil units [47].

Despite being focused on DGCS, the results of this study are also relevant to mechanical cooling applications with ground-source heat pump systems. For cooling-dominated ground-source heat pumps, reducing the peak hourly loads of the building could reduce the required length of BHEs and the cooling plant size thus decreasing the electrical energy consumption. Further research is warranted studying the influence of operating strategies of the building cooling system on the design and performance of the ground-source heat pump systems.

## 6. Conclusions

This study investigates the influence of applying a cooling control strategy that creates peak shaving for building cooling loads on the ground loads, borehole sizing and borehole outlet fluid temperature. The control strategy applied in this study allows peak shaving by incorporating a continuous cooling operation strategy and variable room temperature measures. The following points summarise the major findings of this study.

- The borehole system benefits from applying the continuous operation strategy that creates peak shaving, as the heat injection rate to the ground significantly reduces during the peak hours. Given the simulation conditions in this study, the maximum ground load showed a reduction of about 28%.
- For the existing BHE in this study, applying the continuous cooling strategy caused the maximum borehole outlet fluid temperature to decrease by 0.8 K. A lower supply temperature could enhance the cooling capacity for the building cooling system.
- For the new BHE in this study, applying the continuous cooling strategy allows the BHE depth to be decreased by approximately 18% (from 200 m to 165 m), due to the lower peak ground heat injection rates.
- Room temperature under the continuous operation strategy varies with the room cooling load. The results for the simulated office confirm that neither the rate nor the maximum amount of room temperature violated the recommended criteria for thermal comfort. On the peak day, the room operative temperature was only 1.0 K warmer under the continuous control strategy than when the system was operated with a more conventional intermittent control strategy.

- Results on the ground load indicate that the continuous control strategy studied in this article can significantly reduce the required depth of the boreholes.

Future studies on this topic are therefore suggested to assess the influence of control strategies that imply peak shaving measures in the sizing of boreholes.

### CRedit authorship contribution statement

**Taha Arghand:** Methodology, Validation, Writing - original draft, Investigation. **Saqib Javed:** Supervision, Writing - review & editing. **Anders Trüschel:** Supervision, Writing - review & editing. **Jan-Olof Dalenbäck:** Project administration, Supervision, Writing - review & editing.

### Declaration of Competing Interest

The authors declare that they have no known competing financial interests or personal relationships that could have appeared to influence the work reported in this paper.

### Acknowledgements

This work was financially supported by the Swedish Energy Agency (Energimyndigheten) through its E2B2 national research programme. The in-kind contribution of laboratory facilities by Swegon and Lindab is gratefully appreciated. We are particularly grateful to Håkan Larsson for his lab assistance. Valuable discussions with Carl-Ola Danielsson (Swegon) and Göran Hultmark (Lindab) are also acknowledged.

### Appendix A. Supplementary data

Supplementary data to this article can be found online at <https://doi.org/10.1016/j.enbuild.2020.110709>.

### References

- [1] U. Eicker, C. Vorschulze, Potential of geothermal heat exchangers for office building climatization, *Renew. Energy* 34 (4) (2009) 1126–1133, <https://doi.org/10.1016/j.renene.2008.06.019>.
- [2] Yi. Man, H. Yang, Y. Qu, Z. Fang, Feasibility investigation of the low energy consumption cooling mode with ground heat exchanger and terminal radiator, *Procedia Eng.* 121 (2015) 423–429, <https://doi.org/10.1016/j.proeng.2015.08.1088>.
- [3] A. Rabl, L.K. Norford, Peak load reduction by preconditioning buildings at night, *Int. J. Energy Res.* 15 (9) (1991) 781–798, <https://doi.org/10.1002/er.4440150909>.
- [4] J.P. Coniff, Strategies for reducing peak air conditioning loads by using heat storage in the building structure, *ASHRAE Trans.* 97 (1991) 704–709.
- [5] D. Olsthoorn, F. Haghighat, A. Moreau, G. Lacroix, Abilities and limitations of thermal mass activation for thermal comfort, peak shifting and shaving: a review, *Build. Environ.* 118 (2017) 113–127, <https://doi.org/10.1016/j.buildenv.2017.03.029>.
- [6] J.E. Braun, Load control using building thermal mass, *J. Sol. Energy Eng. Trans. ASME.* 125 (2003) 292–301. doi:10.1115/1.1592184.
- [7] B.W. Olesen, Thermo active building systems: using building mass to heat and cool, *ASHRAE J.* 54 (2012) 44–52.
- [8] G.N. Spyropoulos, C.A. Balaras, Energy consumption and the potential of energy savings in Hellenic office buildings used as bank branches—A case study, *Energy Build.* 43 (4) (2011) 770–778, <https://doi.org/10.1016/j.enbuild.2010.12.015>.
- [9] M. Avci, M. Erkoc, A. Rahmani, S. Asfour, Model predictive HVAC load control in buildings using real-time electricity pricing, *Energy Build.* 60 (2013) 199–209, <https://doi.org/10.1016/j.enbuild.2013.01.008>.
- [10] W. Tushar, T. Wang, L. Lan, Y. Xu, C. Withanage, C. Yuen, K.L. Wood, Policy design for controlling set-point temperature of ACs in shared spaces of buildings, *Energy Build.* 134 (2017) 105–114, <https://doi.org/10.1016/j.enbuild.2016.10.027>.
- [11] K. Le, T. Tran-Quoc, J.C. Sabonnadière, C. Kieny, N. Hadjsaid, Peak load reduction by using air-conditioning regulators, *Proc. Mediterr. Electrotech. Conf. - Melecon.* (2008) 713–718, <https://doi.org/10.1109/MELCON.2008.4618519>.
- [12] A. Baniyasi, D. Habibi, O. Bass, M.A.S. Masoum, Optimal real-time residential thermal energy management for peak-load shifting with experimental verification, *IEEE Trans. Smart Grid* 10 (5) (2019) 5587–5599, <https://doi.org/10.1109/TSG.2018.2887232>.
- [13] C. Yavuzturk, J. Spitler, Comparative study of operating and control strategies for hybrid ground-source heat pump systems using a short time step simulation model, *ASHRAE Trans.* 106 (2000) 192–209.
- [14] C. Yavuzturk, Modeling of vertical ground loop heat exchangers for ground source heat pump systems, Oklahoma State University, Oklahoma, USA, 1999.
- [15] J.R. Cullin, J.D. Spitler, A computationally efficient hybrid time step methodology for simulation of ground heat exchangers, *Geothermics* 40 (2) (2011) 144–156, <https://doi.org/10.1016/j.geothermics.2011.01.001>.
- [16] J. Claesson, S. Javed, A load-aggregation method to calculate extraction temperatures of borehole heat exchangers, *ASHRAE Trans.* 118 (2012) 530–539.
- [17] M.A. Bernier, Ground-coupled heat pump system simulation, *ASHRAE Trans.* 107 (2001) 605–616.
- [18] J. Romani, L.F. Cabeza, G. Pérez, A.L. Pisello, A. de Gracia, Experimental testing of cooling internal loads with a radiant wall, *Renew Energy* 116 (2018) 1–8, <https://doi.org/10.1016/j.renene.2017.09.051>.
- [19] J. Romani, G. Pérez, A. de Gracia, Experimental evaluation of a cooling radiant wall coupled to a ground heat exchanger, *Energy Build.* 129 (2016) 484–490, <https://doi.org/10.1016/j.enbuild.2016.08.028>.
- [20] T. Arghand, S. Javed, A. Trüschel, J.-O. Dalenbäck, Cooling of office buildings in cold climates using direct ground-coupled active chilled beams, *Renew Energy* 164 (2021) 122–132, <https://doi.org/10.1016/j.renene.2020.09.066>.
- [21] A. Li, X. Xu, Y. Sun, A study on pipe-embedded wall integrated with ground source-coupled heat exchanger for enhanced building energy efficiency in diverse climate regions, *Energy Build.* 121 (2016) 139–151, <https://doi.org/10.1016/j.enbuild.2016.04.005>.
- [22] W. Lyu, X. Li, S. Yan, S. Jiang, Utilizing shallow geothermal energy to develop an energy efficient HVAC system, *Renew Energy* 147 (2020) 672–682, <https://doi.org/10.1016/j.renene.2019.09.032>.
- [23] J.D. Spitler, J.R. Cullin, Misconceptions Regarding Design of Ground-source Heat Pump Systems, in: *World Renew. Energy Congr.*, Glasgow, Scotland, 2008.
- [24] P. Bayer, M. de Paly, M. Beck, Strategic optimization of borehole heat exchanger field for seasonal geothermal heating and cooling, *Appl. Energy* 136 (2014) 445–453, <https://doi.org/10.1016/j.apenergy.2014.09.029>.
- [25] T. You, W. Wu, W. Shi, B. Wang, X. Li, An overview of the problems and solutions of soil thermal imbalance of ground-coupled heat pumps in cold regions, *Appl. Energy* 177 (2016) 515–536, <https://doi.org/10.1016/j.apenergy.2016.05.115>.
- [26] K.P. Tsagarakis, L. Efthymiou, A. Michopoulos, A. Mavragani, A.S. Andelković, F. Antolini, M. Bacic, D. Bajare, M. Baralis, W. Bogusz, S. Burlon, J. Figueira, M.S. Genç, S. Javed, A. Jurelionis, K. Koca, G. Rzyżyński, J.F. Urchueguia, B. Žlender, A review of the legal framework in shallow geothermal energy in selected European countries: need for guidelines, *Renew. Energy* 147 (2020) 2556–2571, <https://doi.org/10.1016/j.renene.2018.10.007>.
- [27] J.D. Spitler, S. Javed, R.K. Ramstad, Natural convection in groundwater-filled boreholes used as ground heat exchangers, *Appl. Energy* 164 (2016) 352–365, <https://doi.org/10.1016/j.apenergy.2015.11.041>.
- [28] S. Javed, J.D. Spitler, P. Fahlén, An experimental investigation of the accuracy of thermal response tests used to measure ground thermal properties, *ASHRAE Trans.* 117 (2011) 13–22.
- [29] S. Javed, Design of ground source heat pump systems: Thermal modelling and evaluation of boreholes, Chalmers University of Technology, Gothenburg, Sweden, 2010.
- [30] A. Simone, J. Babiak, M. Bullo, G. Landkilde, B.W. Olesen, Operative Temperature for Control of Radiant Surface Heating and Cooling Systems, in: *Clima 2007 WellBeing Indoors, FINVAC, Helsinki, Finland, 2007*: pp. 233–237.
- [31] J. Feng, Design and control of hydronic radiant cooling systems, University of California, Berkeley, 2014. <http://escholarship.org/uc/item/6qc4p0fr> Preferred.
- [32] ASHRAE, Nonresidential Cooling and Heating, in: *ASHRAE Handb. Fundam.*, American Society of Heating, Refrigerating and Air-conditioning Engineers, Atlanta, USA, 2017: pp. 18.1–18.66.
- [33] S. Moosberger, Report: IDA ICE CIBSE-Validation: test of IDA Indoor Climate and Energy version 4.0 according to CIBSE TM33, issue 3, Lucerne University of Applied Sciences and Arts, Luzern, Switzerland, 2007. [http://www.equonline.com/iceuser/validation/ICE-Validation-CIBSE\\_TM33.pdf](http://www.equonline.com/iceuser/validation/ICE-Validation-CIBSE_TM33.pdf).
- [34] EQUA Simulation Technology Group, Technical report: Validation of IDA Indoor Climate and Energy 4.0 build 4 with respect to ANSI/ASHRAE Standard 140-2004, EQUA Simulation Technology Group, Stockholm, Sweden, 2010.
- [35] S. Kropf, G. Zweifel, Validation of the Building Simulation Program IDA-ICE According to CEN 13791 “Thermal Performance of Buildings - Calculation of Internal Temperatures of a Room in Summer Without Mechanical Cooling - General Criteria and Validation Procedures”, Lucerne University of Applied Sciences and Arts, Luzern, Switzerland, 2001.
- [36] ASHRAE, *ASHRAE Handbook - HVAC Fundamentals*, American Society of Heating, Refrigerating and Air-conditioning Engineers, Atlanta, USA, 2017.
- [37] EQUA Simulation Technology Group, User Guide: Borehole 1.0, EQUA Simulation Technology Group, Stockholm, Sweden, 2014. <http://www.equonline.com/iceuser/pdf/UserGuideBoreholes.pdf>.
- [38] L. Eriksson, P. Skogqvist, Description of the IDA ICE borehole model, Internal Report, EQUA Simulation Technology Group, Stockholm, Sweden, 2017.

- [39] Lin Liu, Zhuang Yu, Hui Zhang, Hongwei Yang, Performance improvements of a ground sink direct cooling system under intermittent operations, *Energy Build.* 116 (2016) 403–410, <https://doi.org/10.1016/j.enbuild.2016.01.032>.
- [40] Qing Gao, Ming Li, Ming Yu, Experiment and simulation of temperature characteristics of intermittently-controlled ground heat exchanges, *Renew. Energy* 35 (6) (2010) 1169–1174, <https://doi.org/10.1016/j.renene.2009.10.039>.
- [41] Seung Hyo Baek, Myoung Souk Yeo, Kwang Woo Kim, Effects of the geothermal load on the ground temperature recovery in a ground heat exchanger, *Energy Build.* 136 (2017) 63–72, <https://doi.org/10.1016/j.enbuild.2016.11.056>.
- [42] ISO, ISO 7730- Ergonomics of the thermal environment – Analytical determination and interpretation of thermal comfort using calculation of the PMV and PPD indices and local thermal comfort criteria, International Organization for Standardization, Brussels, 2014.
- [43] CEN, EN 15251- Indoor environmental input parameters for design and assessment of energy performance of buildings addressing indoor air quality, thermal environment, lighting and acoustics, European Committee for Standardization, Brussels, Belgium, 2007.
- [44] ASHRAE, ASHRAE Standard 55: Thermal environmental conditions for human occupancy, ASHRAE, Atlanta, USA, 2004.
- [45] B.W. Olesen, M. De Carli, M. Scarpa, M. Koschenez, *Dynamic evaluation of the cooling capacity of thermo-active building systems*, *ASHRAE Trans.* 112 (2006).
- [46] T. Arghand, S. Javed, A. Trüschel, J. Dalenbäck, Control methods for a direct-ground cooling system: an experimental study on office cooling with ground-coupled ceiling cooling panels, *Energy Build.* 197 (2019) 47–56, <https://doi.org/10.1016/j.enbuild.2019.05.049>.
- [47] P. Fahlén, C. Markusson, C.H. Stignor, Capacity control of liquid-cooled air-coolers, in: 22nd Int. Congr. Refrig., International Institute of Refrigeration, Beijing, China, 2007.