

THESIS FOR THE DEGREE OF DOCTOR OF PHILOSOPHY

Does Form Follow Function?

CONNECTING FUNCTION MODELLING AND GEOMETRY
MODELLING FOR DESIGN SPACE EXPLORATION

JAKOB R. MÜLLER



CHALMERS

Department of Industrial and Materials Science
CHALMERS UNIVERSITY OF TECHNOLOGY

Göteborg, Sweden 2020

Does Form Follow Function?

Connecting Function Modelling and Geometry Modelling for Design
Space Exploration

JAKOB R. MÜLLER

ISBN: 978-91-7905-412-0

© JAKOB R. MÜLLER, 2020.

Doktorsavhandlingar vid Chalmers tekniska högskola

Ny serie nr 4879

ISSN 0346-718X

Department of Industrial and Materials Science

Division of Product Development

CHALMERS UNIVERSITY OF TECHNOLOGY

SE-412 96 Göteborg

Sweden

Telephone: +46 (0)31 – 772 1000

Email: jakob.muller@chalmers.se; jakobramonmueller@gmail.com

Typeset by the author using L^AT_EX.

Chalmers Reproservice

Göteborg, Sweden 2020

Hier steh ich nun ich armer Tor,
und bin so klug als wie zuvor.

J. W. von Göthe

Abstract

The aerospace industry, representative of industries developing complex products, faces challenges from changes in user behaviour, legislation, environmental policy. Meeting these challenges will require the development of radically new products.

Radically new technologies and solutions need to be explored, investigated, and integrated into existing aerospace component architectures. The currently available design space exploration (DSE) methods, mainly based around computer-aided design (CAD) modelling, do not provide sufficient support for this exploration. These methods often lack a representation of the product's architecture in relation to its design rationale (DR)—they do not illustrate how *form follows function*. Hence, relations between different functions and solutions, as well as how novel ideas relate to the legacy design, are not captured. In particular, the connection between a product's function and the embodiment of its solution is not captured in the applied product modelling approaches, and can therefore not be used in the product development process.

To alleviate this situation, this thesis presents a combined function- and geometry-modelling approach with automated generation of CAD models for variant concepts. The approach builds on enhanced function-means (EF-M) modelling for representation of the design space and the legacy design's position in it. EF-M is also used to capture novel design solutions and reference them to the legacy design's architecture.

A design automation (DA) approach based on modularisation of the CAD model, which in turn is based on the functional decomposition of the product concepts, is used to capture geometric product information. A combined function-geometry object model captures the relations between functions, solutions, and geometry. This allows for CAD models of concepts based on alternative solutions to be generated.

The function- and geometry-exploration (FGE) approach has been developed and tested in collaboration with an aerospace manufacturing company. A proof-of-concept tool implementing the approach has been realised. The approach has been validated for decomposition, innovation, and embodiment of new concepts in multiple studies involving three different aerospace suppliers. Application of FGE provides knowledge capture and representation, connecting the teleological and geometric

ABSTRACT

aspects of the product. Furthermore, it supports the exploration of increasingly novel solutions, enabling the coverage of a wider area of the design space.

The connection between the modelling domains addresses a research gap for the “integration of function architectures with CAD models”.

While the FGE approach has been tested in laboratory environments as well as in applied product development projects, further development is needed to refine CAD integration and user experience and integrate additional modelling domains.

Keywords: product development, function modelling, design space exploration, knowledge based engineering, design automation, product models, engineering design, systems engineering

Acknowledgments

The research presented in this thesis has been carried out at the Department for Industrial and Materials Science (IMS) at Chalmers University of Technology in Göteborg Sweden. It has been financially supported by the Swedish Governmental Agency for Innovation Systems (VINNOVA) and the Swedish Aeronautics Research Programme (NFFP) through the projects VITUM and MEPHISTO, as well as by the Swedish National Space Agency through the project RIQAM. This financial support is gratefully acknowledged.

First of all, I want to thank my supervisor Ola Isaksson for motivating me when I stopped seeing the meaning in all this and guiding me through the fine arts of academic work. Further thanks deserves Massimo Panarotto, my co-supervisor, who was always there to discuss my research, results and publications. During my first two years, I also had the pleasure to be co-supervised by Christoffer Levandowski, whom I also would like to thank at this point. Beyond these three people, there are many co-authors and co-workers at Chalmers who deserve my thanks and gratitude.

Most of the presented research has been performed in collaboration with GKN Aerospace in Trollhättan, Sweden. I would like to thank Johan Lööf, who always was my reliable interface to the company. Furthermore Niklas Olofsson and his development team, who endured me in their meetings and my workshops. Special thanks to Petter Andersson, who blessed me with the quote: "If you're not having fun in your PhD, you're doing it wrong!". I tried to take it to heart.

Ein ganz besonderer Dank gilt meinen Eltern, Hanna und Reinhard, und meiner Schwester Jule. Ohne eure Hilfe, Liebe und Unterstützung wäre ich nie so weit gekommen.

Und am allerwichtigsten: Liebe Elena, vielen Dank für dein Verständnis, deine Zuneigung und einfach nur dass du bei mir bist. Nur mit dir an meiner Seite war das hier möglich.

*Jakob Müller
Göteborg, November 2020*

List of Publications

This thesis is based on the following appended papers:

- Paper A** Müller, J.R., Panarotto, M. and Isaksson, O. (2019), "Connecting functional and geometrical representations to support the evaluation of design alternatives for aerospace components", *in ICED19: 22nd International Conference on Engineering Design*, Delft, Netherlands, August 2019.
- Paper B** Müller, J.R., Siiskonen, M. and Malmqvist, J. (2020), "Lessons Learned from the Application of Enhanced Function-Means Modelling", *in DESIGN 2020 - 16th International Design Conference*, Cavtat, Croatia [online], October 2020.
- Paper C** Müller, J.R., Isaksson, O., Landahl, J., Raja, V., Panarotto, M., Levandowski, C.E. and Raudberget, D. (2019), "Enhanced function-means modeling supporting design space exploration", *in Artificial Intelligence for Engineering Design and Manufacturing AIEDAM*, Vol. 33 No. 4
- Paper D** Müller, J.R., Borgue, O., Panarotto, P., Isaksson, O. (2020), "Mapping the design space in function and geometry models for re-design for additive manufacturing", *accepted for publication in Journal of Design Research*
- Paper E** Müller, J.R., Panarotto, M. and Isaksson, O. (2021), "Function model based generation of CAD model variants", *accepted for publication in CAD and Application*
- Paper F** Müller, J.R., Panarotto, M., Isaksson, O., "Design Space Exploration of a Jet Engine Component using a Combined Object Model for Function and Geometry", *under review for MDPI Aerospace*

Work distribution in the appended papers

- Paper A** Müller, J.R. was the lead author and orchestrated the writing and data collection processes. Panarotto, M. and Isaksson O. contributed through planning and performing the underlying study, as well as supervising and editing the paper.
- Paper B** Müller, J.R. and Siiskonen, M. designed and performed the presented study in collaboration. Müller, J.R. was the lead author, whereas Siiskonen, M. contributed equally to the writing. Malmqvist, J. supervised the study and the writing process and contributed by editing and commenting on the paper.
- Paper C** Müller, J.R. was the lead author and designed the presented approach and orchestrated the writing and data collection process. Panarotto, M. and Isaksson, O. each wrote sections of the paper, and contributed by supervising and editing. Landahl, J., Raja, V., Levandowski, C.E. and Raudberget, D. contributed to the modelling and data collection. All authors contributed with comments and by writing subsections of the final paper.
- Paper D** Müller, J.R. and Borgue, O. designed and performed the presented study in collaboration. Müller, J.R. led the writing process, to which Borgue, O. and Panarotto, M. contributed in parts. Isaksson, O. supervised the study and the writing process and contributed by editing and commenting on the paper.
- Paper E** Müller, J.R. developed the presented approach and proof-of-concept tool. Müller, J.R. also wrote the paper. Panarotto, M. and Isaksson O. contributed by supervising and editing the paper.
- Paper F** Müller, J.R. designed and performed the presented study. Müller, J.R. wrote the paper, to which Panarotto, M. contributed. Isaksson, O. supervised the study and the writing process and contributed by editing and commenting on the paper.

Other related publications by the author not included in this thesis:

- [i] Isaksson, O., Bertoni, A., Levandowski, C.E., Müller, J.R., Wiklund, D. and Johannesson, H., 2016., "Virtual contextual validation of technologies and methods for product development", *in* International Design Conference, DESIGN, Cavtat, Croatia
- [ii] Raudberget, D., Landahl, J., Levandowski, C.E. and Müller, J.R., 2016. "Bridging the gap between functions and physical components through a structured functional mapping chart", *in* 2016 ISPE International Conference on Transdisciplinary Engineering, Curitiba, Parana, Brazil
- [iii] Levandowski, C.E., Müller, J.R. and Isaksson, O., 2016. "Modularization in Concept Development Using Functional Modeling", *in* 2016 ISPE International Conference on Transdisciplinary Engineering, Curitiba, Parana, Brazil
- [iv] Isaksson, O., Arnarsson, Í., Bergsjö, D., Catic, A., Gustafsson, G., Kaya, O., Landahl, J., et al., 2017. "Trends, observations and drivers for change in systems engineering design", *in* ICED17: 21st International Conference on Engineering Design, Vancouver, Canada
- [v] Raudberget, D., Levandowski, C.E., André, S.E., Isaksson, O., Elgh, F., Müller, J.R., Johansson, J., et al., 2017. "Supporting design platforms by identifying flexible modules", ICED17: 21st International Conference on Engineering Design, Vancouver, Canada
- [vi] Borgue, O., Müller J.R., Panarotto M., Isaksson O., 2018. "Function Modelling and Constraints Replacement for Additive Manufacturing in Satellite Component Design." *in* Proceedings of NordDesign 2018, Linköping, Sweden
- [vii] Müller, J.R., Panarotto, M., Malmqvist, J. and Isaksson, O., 2018. "Lifecycle design and management of additive manufacturing technologies", *in* Procedia Manufacturing - 6th International Conference on Through-Life Engineering Services, Vol. 19, Elsevier
- [viii] Lithgow, D., Morrison, C., Pexton, G., Panarotto, M., Müller, J. R., Almefelt, L., McLaren, A., 2019. "Design Automation for Customised and Large-Scale Additive Manufacturing: A Case Study on Custom Kayaks." *in* ICED19: 22nd International Conference on Engineering Design, Delft, Netherlands
- [ix] Borgue, O., Müller, J.R., Leicht, A., Panarotto, M. and Isaksson, O., 2019. "Constraint replacement-based design for additive manufacturing of satellite components: Ensuring design manufacturability through tailored test artefacts", *in* Aerospace, Vol. 6 No. 11
- [x] Bonham, E., McMaster, K., Thomson, E., Panarotto, M., Müller, J.R., Isaksson, O., Johansson, E., 2020. "Designing and Integrating a Digital Thread System for Customized Additive Manufacturing in Multi-Partner Kayak Production" *in* Systems, Vol. 8 No. 43

Acronyms

AM	additive manufacturing	FBS	function-behaviour-structure
API	application programming interface		
C	constraint	FEM	finite element method
C_f	functional constraint	FGE	function- and geometry-exploration
C_m	manufacturing constraint	FR	functional requirement
CCA	contact and channel approach	HiCED	Hierarchical Co-Evolutionary Design
CAD	computer-aided design	HLcT	high-level CAD templates
DA	design automation	icb	is constrained by
DACM	dimensional analysis conceptual modeling	IFM	Integrated Function Modelling
DfM	design for manufacturing	isb	is solved by
DP	design parameter	IP	intellectual property
DR	design rationale	IT	information technology
DRM	design research methodology	iw	interacts with
DS	design solution	KBE	knowledge-based engineering
DS1	descriptive study one	KBMM	knowledge-based master models
DS2	descriptive study two	MDA	multi-disciplinary analysis
DSE	design space exploration	MDO	multi-disciplinary optimisation
DSM	design structure matrix	NURBS	non-uniform rational B-spline
EDR	engineering design research	GV	guide vane
EF-M	enhanced function-means	OMFG	object model for function and geometry
EoL	end of life		

ACRONYMS

omfgDSE	object model for function and geometry based design space exploration	SBCE	set-based concurrent engineering
PDP	product development process	SysML	systems modelling language
PLM	product life-cycle management	TRA	turbine rear assembly
PS	prescriptive study	TRL	technology readiness level
rf	requires function	TRS	turbine rear structure
RQ	research question	UDF	user defined feature
SoAR	spiral of applied research	UI	user interface
SDD	simulation driven design	UML	unified modelling language
SE	systems engineering	UX	user experience
		VDD	value-driven design

Contents

Abstract	i
Acknowledgments	iii
List of Publications	v
Acronyms	ix
Contents	xi

I Introductory Chapters

1 Introduction	1
1.1 Background	2
1.1.1 Specific challenges for the aerospace industry . . .	2
1.1.2 A practical example	3
1.1.3 The challenges of design space exploration	5
1.2 Research focus	6
1.2.1 Industrial problem	6
1.2.2 Research gap	7
1.2.3 Research claim and questions	9
1.2.4 Scope and delimitations	9
2 Frame of Reference	11
2.1 Products: function and form	11
2.2 Product development	12
2.2.1 Engineering Design	14
2.2.2 Systems Engineering	16
2.3 Product models	17
2.3.1 Function models	17
2.3.2 Geometry models	19

CONTENTS

2.4	Design space exploration	21
3	Research approach	25
3.1	Between science and engineering	25
3.2	Research methodologies	27
3.2.1	Design research methodology	27
3.2.2	The spiral of applied research	28
3.2.3	Validation in engineering design research	29
3.3	Applied research framework	30
3.4	Adopted research methods	32
3.4.1	Verification and validation	35
4	Research results	37
4.1	Summary of appended publications	37
4.1.1	Paper A: Connecting functional and geometrical representation to support the evaluation of design alternatives for aerospace components	38
4.1.2	Paper B: Lessons learned from the application of a function-means modelling method	39
4.1.3	Paper C: Enhanced function-means modeling supporting design space exploration	40
4.1.4	Paper D: Mapping the design space in function and geometry models for re-design for AM	42
4.1.5	Paper E: Function model based generation of CAD model variants	44
4.1.6	Paper F: Improved design space exploration through function-based configuration of geometrical product models	46
4.2	FGE: Function- and geometry-based design space exploration	47
4.2.1	The function- and geometry-modelling-based design space exploration approach	48
4.2.2	The object model for function and geometry	51
4.2.3	The FGE approach applied	56
5	Discussion	61
5.1	Answers to research questions	61
5.1.1	Answers to research question 1	62
5.1.2	Answers to research question 2	63
5.1.3	Answers to research question 3	64
5.2	Verification and Validation	65
5.2.1	Validity of research questions	66
5.2.2	Verification of the method	67

5.2.3	Usefulness of the method	68
5.2.4	Method use	69
5.2.5	Reflections	70
6	Conclusions	73
6.1	Contribution and claim	74
6.2	Future work	74
	References	77

II Appended Papers

Paper A	Connecting functional and geometrical representations to support the evaluation of design alternatives for aerospace components	91
Paper B	Lessons Learned from the Application of Enhanced Function-Means Modelling	103
Paper C	Enhanced function-means modeling supporting design space exploration	115
Paper D	Mapping the design space in function and geometry models for re-design for additive manufacturing	133
Paper E	Function model based generation of CAD model variants	157
Paper F	Design Space Exploration of a Jet Engine Component using a Combined Object Model for Function and Geometry	179

Part I

Introductory Chapters



Introduction

Form follows function.

Louis Sullivan

Function plays a crucial role in product development: fulfilling its function is how a product creates value (Roozenburg and Eekels, 1995). At the beginning of the design process, the functions of a product are defined, and for each of these functions, solutions are identified, which are then realised as physical artefacts: the product's *form*. To paraphrase Suh (1990), design is what relates function and form. Clearly, form *does* follow function—chronologically in the product development process, but also causally through the design activity.

To represent the form and function of a product, developers use different product models. However, the de facto standard product representation is a model of the *form*, a computer-aided design (CAD) model. There are hardly any models used in product development that focus on the representation of a product's *function* (Tomiyama et al., 2013). Furthermore, the two modelling domains, function and geometry (form), are not connected (Cohrs et al., 2014), thwarting the development of truly novel, radical product designs.

In the development of complex products, especially, engineers often have to pursue incremental development of a previous design instance, the *legacy design* (Prasad, 2006). The available CAD models of the legacy design are too rigid to easily implement multiple architecturally different solutions (Kasik et al., 2005; Woodbury and Burrow, 2006). Furthermore, the lack of function representation in CAD results in lack of support for *functional* or *innovative* design (Umeda and Tomiyama, 1997).

This thesis develops and tests a design space exploration (DSE) approach that aims to support the exploration of more novel product concepts by capturing and representing how *form follows function*. The combined function- and geometry-modelling approach enables the representation of both the legacy design and novel design solutions, along with their relations to the design space. Additionally, the approach enables the automated generation of CAD models for novel concepts with less effort compared to manual modelling. The approach has been developed and validated in collaboration with companies in the aerospace sector.

1.1 Background

Changes in customer behaviour, the invention of new technologies, and external challenges such as new legislation all require the development of novel products that outperform the legacy design. In most cases, this legacy design is available from previous product development. If not, in a so-called *green-field* design process, the new product is defined and designed from scratch.

If a legacy design is available, it provides developers with initial information about stakeholders, main functions, and potential solutions. Furthermore, the developers already possess well-tested knowledge from the previous development process. However, this knowledge, especially about the product's design rationale (DR), is mostly *stored in the walls* of organisation; i.e., it is, as Henderson and Clark (1990) put it, managed implicitly, "embedd[ed] in their communication channels, information filters, and problem-solving strategies".

The challenge for product developers is now to identify, develop, and test new functions and solutions that provide what stakeholders need from the new product. These functions and solutions then have to be integrated in the architecture of the legacy design, resulting in new, and better, products.

1.1.1 Specific challenges for the aerospace industry

Newly developed aircraft and components have to meet complex and specific requirements. For example, the Airbus A380 was developed to be able to "travel from Singapore to London against adverse winter winds", carrying 550 people and cargo, and all of this at a cost that was 15% to 20% less than for previous aircraft (Jupp, 2016). Furthermore, aircraft have to meet not only an expectation of safety but one of high reliability, so as to

“arrive within 1 minute of the planned arrival time regardless of weather conditions” (Darecki et al., 2011).

Beyond that, the aerospace industry is facing a growing number of new challenges, from new user behaviour such as “flygskam”¹ (Umair Irfan, 2019) and new targets for emissions (ACARE, 2017), to unexpected global phenomena such as the COVID-19 pandemic (Devezas, 2020; Schmidt and Gelle, 2020). Developing aircraft and components that comply with these new stakeholder needs may require development beyond incremental changes to legacy designs (Lawson and Samson, 2001; Henderson and Clark, 1990). Such leaps in performance may only be achieved with radical solutions, such as open rotor fans (Larsson et al., 2011) and electric, or electric-hybrid, engines (Dale et al., 2020; Moore, 2014).

Especially in the development of aircraft engine components, the product is often subject to tough requirements relating to safety and reliability, requiring extensive testing of the concepts (physically or through simulation) (Isaksson, 2016).

All the points above lead to a tendency among developers in the aerospace industry to rely on a “concept of similarity” by relying on well-known and well-researched solutions, whereas radically novel concepts have a hard time proving themselves against these established designs.

1.1.2 A practical example

This section presents experiences with product development at an aerospace company in order to illustrate the challenges that the industry faces. The section is based on a case study, about which the author collaborated on two publications:

- Isaksson et al. (2016), Paper [i], reports on the original challenges that prompted the study, see below.
- Paper A reports on the study after its conclusion, three years after Paper [i], providing a more reflective perspective on the impacts of the study. The findings are presented in Chapter 4.

In the study, the case company was about to develop a new turbine rear assembly (TRA), which had to comply with new temperature requirements. These new, higher temperatures were due to higher combustion temperatures in the turbine, which in turn enable less fuel consumption (Isaksson et al., 2016). The TRA consists of the low pressure turbine case,

¹Swedish for “flight shame”, a new form of shame associated with the privilege of flying and with the associated environmental impact.

²CAD model by Chris Shakal on grabcad.com

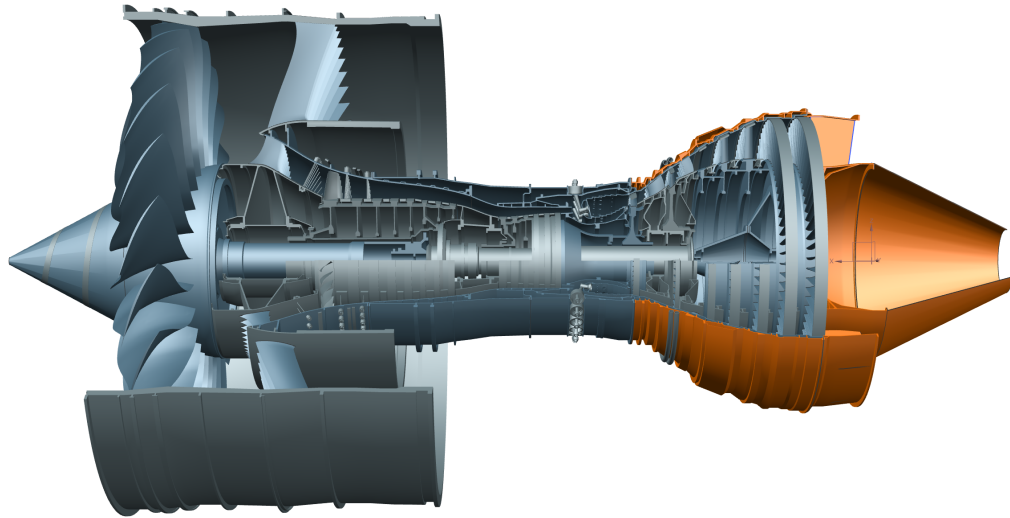

Figure 1.1: A Rolls Royce Trent 900 turbine rendered in CAD², with the turbine rear assembly (TRA) highlighted in orange.

the turbine rear structure (TRS), and the cone, as illustrated in Figure 1.1. The development project was also concerned with exploring new functions for the TRA that could add to its value.

Features and components impacted by the change in temperature were identified based on previous experience of practitioners familiar with the design. New solutions were then identified for the respective components, and novel functions and solutions were devised for the TRA. Next, these novel solutions, such as changes in material or geometry, needed to be integrated into the legacy design's architecture. Like many aerospace components, both the TRA and the TRS have highly integrated architectures (Raja et al., 2019). As a result, the introduction of novel solutions led to design changes propagating throughout the entire product system. These changes had to be identified and traced for each new solution. Each product architecture disruption required further changes, for which multiple alternative solutions could be found. For example, multiple mounting options for the cone to the TRS had to be considered as a result of an alternative material choice for the aft cone. Some of these options are presented in Figure 1.2, illustrating that even changes on a seemingly minor level can lead to geometrically and architectural changes. The combinations of solutions and sub-solutions quickly entailed a large number of possible concepts. Eventually, 1080 different concept variants had to be designed and evaluated.

In order to evaluate all the novel ideas, these concepts had to be rep-

1.1. BACKGROUND

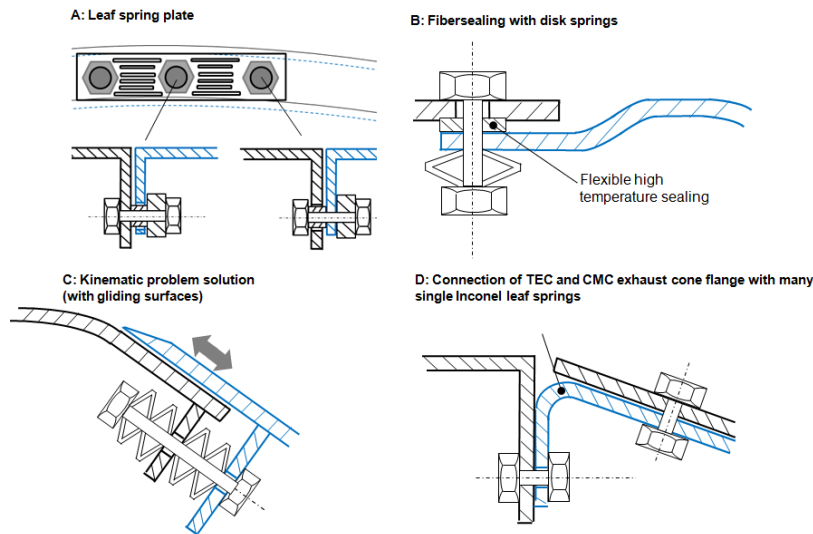

Figure 1.2: Sub-system solutions for the connection between two materials with different thermal expansion coefficients, from Paper A.

resented as CAD models with a sufficient level of detail to enable engineering analysis, such as aerodynamic, thermodynamic, or structural performance (Sandberg et al., 2011). However, generating CAD models for all these potential concepts was too resource intensive. In the presented case, of the 1080 different possible versions, only three concepts could be analysed and evaluated (see Paper A) due to the effort involved in generating the respective CAD models.

1.1.3 The challenges of design space exploration

In order to meet the challenges for the aerospace industry, developers need to investigate multiple, possibly architecturally different, product options. This requires the conception, the representation in models, and the analysis of these possible solutions. For the analysis, CAD models are commonly required. Since the generation, or even simply the variation, of CAD models is a resource-intensive task (Kasik et al., 2005), only a few models can be generated, and as a result, only a few concepts can be evaluated.

It is impossible to explore all concepts in the design space—their number is “astronomically vast” (Woodbury and Burrow, 2006). However, developing the best possible product means evaluating as many concepts as possible. A DSE method meant to support the exploration of a greater number of concepts needs to *define the design space, populate it*

with concepts, and *analyse* them (Kang et al., 2011). These three steps echo the general product development steps by Pahl et al. (2003): “clarify the boundary conditions”, “search for variants”, and “evaluate based on goals and requirements”.

A DSE method would therefore need to be able to: *clarify* the design space, that is, capture requirements, functions, and constraints as well as available product knowledge; support the *search* for solutions and concepts through their capture and representation in adequate models, representing product architecture and DR; *evaluate* concepts, including both, confirm whether the concept lies inside the design space, fulfilling all requirements, and compare their performance with that of other concepts.

1.2 Research focus

This thesis is a work in the field of engineering design research (EDR). As such, it follows a two-fold research approach (Eckert et al., 2003) that seeks to *support engineering design practice* by providing new methods that improve DSE in the conceptual product development phase and also to *generate knowledge* about DSE and the coupling of function and geometry models.

As a result, the research seeks to contribute to solving an *industrial problem* and to closing a *research gap*.

1.2.1 Industrial problem

Solving the challenges facing the aerospace industry will require radical changes to design and architecture, at both the aircraft and component levels. At the engine component level, the radically new solutions have to be integrated in the architecture of a legacy design (Prasad, 2006). This architecture is, especially in the case of aerospace components, highly complex (Raja et al., 2019). As a result, the effects of changes to components propagate through the system (Sinha et al., 2013). The available design models commonly fail to capture product knowledge about the architecture and subsequent effects explicitly (Henderson and Clark, 1990).

As a result, product developers face the challenge of integrating radically new solutions in a complex product, without having access to an explicit representation of the network of relations among the functions, solutions, and constraints that form the legacy product. When developers want to introduce a specific function or improve a specific solution, they need to know:

- which part of the existing geometry is responsible for the fulfilment of the specific function
- how do the geometry, function, and solution relate to the rest of the product architecture.

Otherwise, the development effort could affect other product functions negatively, or might not even contribute to the desired functionality at all.

Once developed, the new solutions have to be evaluated to determine if they

- fulfil the respective function
- violate any constraints, or produce other negative effects/emerging properties.

However, the more similar the solution is to the legacy design, the easier it is to implement, both in the product architecture and in the respective product models. For this reason, conservative solutions end up being favoured over radically new solutions (Isaksson, 2016): Novel solutions are harder to integrate and harder to model, and there is less implicit knowledge available. Furthermore, the reliance on well-known solutions reduces the perceived risk of the development project.

The industrial challenges can be summarised as follows. The DSE methods applied in at the concept development stage of aerospace engine components do not provide sufficient support for

- the representation of the legacy design's DR
- the implications of introducing radically new solutions.

Finally, it is also too resource intensive to generate CAD models of all novel concepts at the level of detail required for engineering analysis.

1.2.2 Research gap

CAD models dominate in product development. Representing a product's *form*, they are useful as a basis for product behaviour analysis, visual representation, and manufacturing preparation. However, CAD models have been considered too rigid for the implementation of radical solutions (Heikkinen et al., 2019; Hoffmann, 2005; Kasik et al., 2005). According to Woodbury and Burrow (2006), CAD models are "made for drawing, not design".

Several methods for automatically generating CAD models, such as parameterisation (Kulfan, 2008), design automation (DA) (Shea et al., 2005),

and knowledge-based engineering (KBE) (La Rocca, 2012; Amadori et al., 2012), have been developed and are used in product development. However, these methods are restricted to dimensional variation and limited design spaces, and hobbled by complex setup processes and a general lack of DR and function representation.

Function models, on the other hand, do capture DR (Bracewell et al., 2009), and can also be used for DSE (Suzuki et al., 2010; Levandowski et al., 2014). Function modelling supports product development through decomposition (Raja and Isaksson, 2015), innovation (Eisenbart et al., 2015), and analysis (Albers and Matthiesen, 2003). However, function models are not common in industrial practice (Tomiya et al., 2013) and therefore rarely used in applied product development.

Function and geometry models can represent the same *product*, but the respective product *properties* represented in the two domains rarely overlap. While some function modelling frameworks do consider geometric aspects, they do so at a much more abstract level than CAD, insufficient for most engineering analysis. Examples include function-behaviour-structure (FBS) (Gero and Kannengiesser, 2004) and contact and channel approach (CCA) (Albers and Sadowski, 2014). Likewise, CAD modelling approaches that consider a product's function or, more often, *behaviour*³ only do so at a very general level. Geometric elements and solutions are not mapped to functions, nor are alternative solutions represented in the same model, cf. Sandberg et al. (2017), which analyses multiple product aspects, such as aerodynamics, cost, and stiffness—without placing them in the context of the expected functions.

As a result, connecting the two modelling domains, function and geometry, is of importance to the research community. Whether for the purpose of investigating innovative design (Umeda and Tomiyama, 1997) or due to the challenges of function models (Tomiya et al., 2013) or the rigidity of CAD models (Heikkinen et al., 2018; Kasik et al., 2005; Woodbury and Burrow, 2006), researchers have called for the “integration of function architectures with CAD models” (Cohrs et al., 2014).

The research gap can be summarised as a lack of connection between the modelling domains of function and geometry. No geometry models that connect to the structure of a product's function have been found, nor any function models capable of representing a product's geometry.

³In the context of this thesis, *function* is defined as “intended behaviour”, see Chapter 2.1.

1.2.3 Research claim and questions

This thesis explores and seeks to validate a central research claim by answering three research questions.

The central research claim is formulated as follows:

A combined function and geometry modelling approach, enabling the automated generation of CAD models of variant concepts, can support developers of aerospace components to explore more product concept variants, including radically novel solutions.

The following research questions (RQs) were formulated to structure the research supporting the central claim. RQ1 and RQ2 were formulated at the beginning of the research process. RQ3 was developed during the research, with the aim of validating the answers to RQ1 and RQ2.

- RQ1 What are the needs for function and geometry models to support the generation and evaluation of a wider variety of concepts?
- RQ2 How can novel product concepts be captured, represented, and evaluated in both function and geometric domains, and how can these two modelling domains be connected to support the automated generation of CAD models from the function model?
- RQ3 How does the application of a product development method that combines the product's function and geometry models support the exploration of radically new design concepts?

1.2.4 Scope and delimitations

Almost everything people interact with these days is a product of some sort and hence the result of a product development process. This thesis is concerned with the development of complex engineering products, especially *aero-engine components*. Therefore, the term “design” is used as in “engineering design” and not to be confused with graphical, industrial, or fashion design.

The term “product” can include, beyond physical artefacts, software, electronics, and services. However, this thesis is mainly concerned with products as physical entities. A physical product is a combination of *material* and *form* (Roozenburg and Eekels, 1995). Although the choice of material—and selection of manufacturing process—has a major influence on a product's performance and properties, this thesis focuses on the product *form*, that is, the product's spatial extension and shape (Hirz et al., 2013).

The product development process spans a wide array of stakeholders, activities, and phases. This thesis focuses on the activities in the *conceptual product development phase*. In this phase, the use of product models for representation of function and geometry are researched, whereas models of electrics, software, or the product life cycle are not directly considered. Furthermore, the focus is on the activities of capture, storage, and representation of product knowledge. Activities such as ideation and the related phenomenon of creativity are not addressed. Although the research focuses on the generation of models for product behaviour analysis, the actual analysis process is not actively considered.

The researched activities in this phase are influenced by many parameters, such as administrative, organisational, and cultural aspects. However, the research claim only focuses on the application and use of *product development methods*, specifically function and geometric modelling. Through the focus on *product function*, stakeholders such as manufacturers—and design for manufacturing (DfM)—are considered, but are not the focus of the research. The same limitation holds for the product life-cycle: only the *product use phase* is considered directly, whereas distribution, end of life (EoL), and recycling are acknowledged, but are not the focus of the research.

Since the research was subject to time and resource constraints, the presented method has only been developed to approximately technology readiness level (TRL) 4 (“validation in laboratory environment”, (Mankins, 1995)), and the tool used for demonstration, testing, and validation has only been developed to TRL 3 (“proof of concept”). However, no official TRL assessment has been performed, and both assessments have been done by the author based on reading of Mankins (1995).

The research was conducted in collaboration with a Swedish manufacturer of aerospace components. While other aerospace development and manufacturing companies participated in several of the research activities, the majority of the data leading to this thesis was collected at a single company.

2

Frame of Reference

*The way you learn anything is that something fails,
and you figure out how not to have it fail again.*

John Kobak

Research is always conducted within frameworks of knowledge developed by earlier research, which set the stage for the methods applied and the results obtained, and for how to interpret these results. Kuhn (1970) calls these kinds of knowledge frameworks “paradigms”.

For this thesis, the relevant paradigms are mainly in the field of *engineering design*, with a focus on the conceptual product development phase. This focus is extended through a *systems engineering* perspective, which provides a more abstract view of the product. Engineering design relies heavily on the use of models to represent products. This chapter discusses *function* as well as *geometry* models, and their use in DSE.

2.1 Products: function and form

“A product is a material system, which is made by people for its properties”, as defined by Roozenburg and Eekels (1995). In developing engineering products, the most important property is the *function* (Suh, 1990). This function is chosen to fulfil the needs of the stakeholders, thereby creating value to them.

The definition of *function* is debated in the EDR community (Eckert et al., 2003), with proposals ranging from “relationship between input and output”, as used by Pahl et al. (2003), to “intended behaviour” by Gero

and Kannengiesser (2004), and “effects of the behaviour” by Lind (1994). Here, the definition “intended behaviour” is used.

The form of the product, on the other hand, is then the result of the design process: “The essential mode of reasoning in designing is to reason from function to form.” (Roozenburg and Eekels, 1995). The form can be distinguished into the geometry, which refers to the shape of the product, and topology, which refers to the relations to the individual shapes towards each other (González-Lluch et al., 2017).

When a product interacts with its environment, i.e., when it is *used*, it shows a *behaviour*. This behaviour has to be anticipated by the designer. In the function-behaviour-structure (FBS) model by Gero and Kannengiesser (2004), the anticipated—i.e., expected—behaviour is denoted “Be”. Analysis of the form (process 3 in Figure 2.1) is required to evaluate whether the actual behaviour (Bs, from “structural behaviour”) matches Be. The relations between function, behaviour, and structure are illustrated in detail in Figure 2.1.

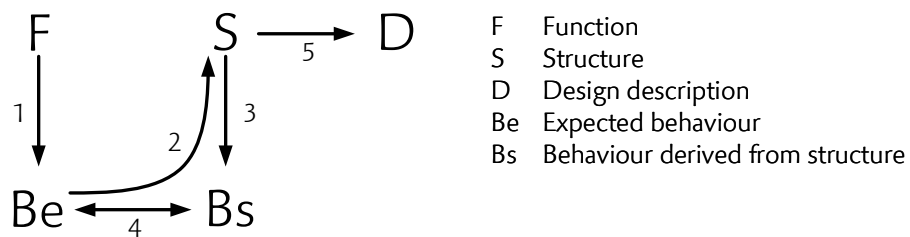

Figure 2.1: The FBS framework after Gero and Kannengiesser (2004). Processes: (1) formulation, (2) synthesis, (3) analysis, (4) evaluation, (5) documentation. Reformulation processes, which are included in the original version of this figure, have been omitted for clarity.

2.2 Product development

This thesis refers to the product development process (PDP) phases and their descriptions as presented by Ulrich and Eppinger (2012), shown in Figure 2.2.

While some definitions consider the PDP to span from “identifying a market opportunity” (Krish, 2011) to “manufacturing preparation” (Pahl et al., 2003), this thesis is mainly concerned with the activities, methods, and tools in the *concept development* phase, specifically *concept generation*

and selection. This assumes that the *customer needs* have already been identified and are available to the developers.

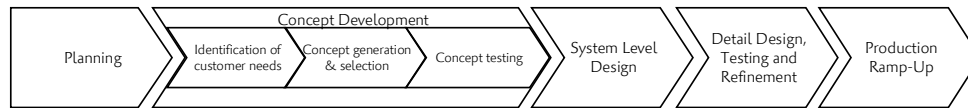

Figure 2.2: Phases of the product development process, after Ulrich and Eppinger (2012).

Here, a *concept* is defined as a description of a product that has the potential to be developed further into a manufacturable, usable artefact. A concept is an individual composition of solutions for the different functions that a product has to fulfil. Concepts are used to investigate different approaches to how to design a product; different concepts differ in their compositions of solutions.

In this context, a *solution* is the fulfilment of a function, in the form of a technical principle (Hubka and Eder, 1988). A solution can, but doesn't have to, include a geometric element (Schachinger and Johannesson, 2000). Multiple solutions can exist for a given function, using different technical principles.

Decisions made in the early phases of the PDP have a large impact on the further development process. A challenge for this phase is that there is very little product knowledge available to base these decisions on—since the product is only about to be developed. This leads to the so called “design paradox” (Mavris et al., 1998)¹, that the decisions with the most impact on the product have to be made when there is the least product knowledge available. This “paradox” is illustrated in Figure 2.3.

In principle, there are two approaches to improve the situation: either to learn more about the product at an earlier phase of the development process (for example through KBE (Verhagen et al., 2012; Isaksson, 2003)), or by pushing the decision about which concept to pursue further back (for example via set-based concurrent engineering (SBCE) (Sobek et al., 1999)). Both of these options are illustrated in Figure 2.3 as dashed lines.

¹While Mavris et al. (1998) presents the design paradox, that might not be the original source. So many authors make un-referenced use of it, that by today it could probably be called “common knowledge” in engineering design research. However, Mavris et al. also present possible solutions to the paradox, which are taken up in Figure 2.3.

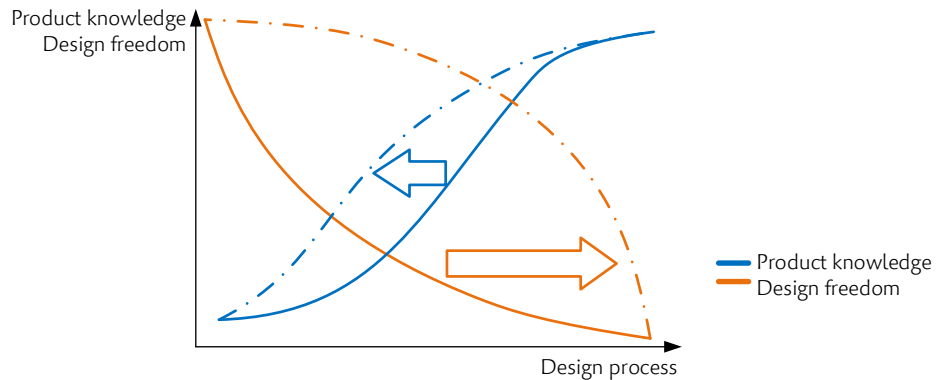

Figure 2.3: The so-called “design paradox”, based on an illustration by Mavris et al. (1998).

2.2.1 Engineering Design

To get from an idea of a product to an artefact is a long and iterative process. Engineering design provides tools and methods for this process, centred around the processes of *finding and evaluating solutions* for the identified product functions (Pahl et al., 2003).

Hubka’s Law states: “The primary functions of a machine system are supported by a hierarchy of subordinate functions, which are determined by the chosen means” (Hubka and Eder, 1988). This means that a product can be broken down into sub-functions with sub-solutions. This decomposition reduces the complexity of the individual solutions, and enables an easier and more nuanced solution-finding process. Once solutions for all sub-functions have been found, they can be assembled into concepts.

The design space in which the product is to be developed is defined by the identified functions, but also by *requirements*. Requirements are a translation of the needs “into a technical description” (Ullman, 2003). Requirements provide measurable target values (or windows) for specific product properties. Functions, on the other hand, state what the product has to *do*. However, requirements can be distinguished as either *functional requirements* or *non-functional requirements*. Functional requirements can be compared to functions, which require a search for solutions, thereby opening up new dimensions in the design space. Non-functional requirements can be seen as constraints, limiting the available design space (Jackson et al., 2009). This is discussed further in Section 2.4.

Requirements management supports this process by keeping track of all requirements and *tracing* them through the PDP (Almefelt et al., 2006). This tracing is often supported by commercial product life-cycle management (PLM) tools. In theory, it should be possible to trace a requirement from stakeholder to component, but this is not always done in applied product development (Nilsson and Fagerström, 2006). Rather, designers commonly interpret requirements as part of concept creation, without explicit tracing or association with design decisions. While such systems are available—and to some degree used—for requirements, functions and their solutions are tracked the same way.

It is important to state that, when capturing requirements and needs—or functions—for a product, their formulation has to remain *solution neutral* (Suh, 1990). Otherwise, the design space is unnecessarily limited, and potentially better solutions can be harder or even impossible to find.

For each of the identified functions, developers find solutions. In the conceptual phases, it is common for different solutions for each function to be developed and then combined into different product concepts (Pahl et al., 2003). This process is referred to as *synthesis*.

These different concepts are then *analysed* to determine if they fulfil all functions as expected. This is done via *product models*, which represent selected product aspects, which are then used to simulate product behaviour (Ullman, 2003). While most analyses use digital models—in most cases CAD models—physical prototype testing is still an important aspect of product development (Jensen et al., 2016). However, the focus in this thesis is on the analyses of computer-based models. The data gained from the analysis process is also used to *verify* the design concept, that is to test whether it complies with all requirements (IEEE, 2017).

If multiple concepts have been developed, they need to be *evaluated* relative to each other. Commonly, the number of concepts under development is reduced after every development phase (Pahl et al., 2003). Only those who best fulfil their functions are brought forward to the next stage of development. However, the evaluation of concepts is difficult, especially in the earlier development phases, where less product knowledge is available, as shown in Figure 2.3. Hence, only concepts for which sufficient information is available, commonly in the form of sufficiently detailed models (Ullman, 2003), can be considered for evaluation and therefore further development.

2.2.2 Systems Engineering

In systems engineering (SE), the product is seen as a system of interacting elements and interfaces (IEEE, 2017). SE is a multidisciplinary approach to product development that “looks at a problem in its entirety”, thereby considering all possible actors and stakeholders of a product (Haskins et al., 2007). In this approach the product is seen as a system inside a “system of systems”. The life-cycle, aim, and interactions are captured for each actor (Albers et al., 2018). SE is prominent in the development of mechatronic or cyber-physical products.

The systems view makes possible a wider focus on the product’s life-cycle and thereby an extended list of stakeholders. This enables an analysis of the product’s *value* from a multi-stakeholder perspective using methods such as value-driven design (VDD) (Collopy and Otero, 2009; Isaksson et al., 2013). The value of a product or technology is defined at a very high level and needs to be iterated through the different system levels and product models of varying fidelity (Panarotto et al., 2018).

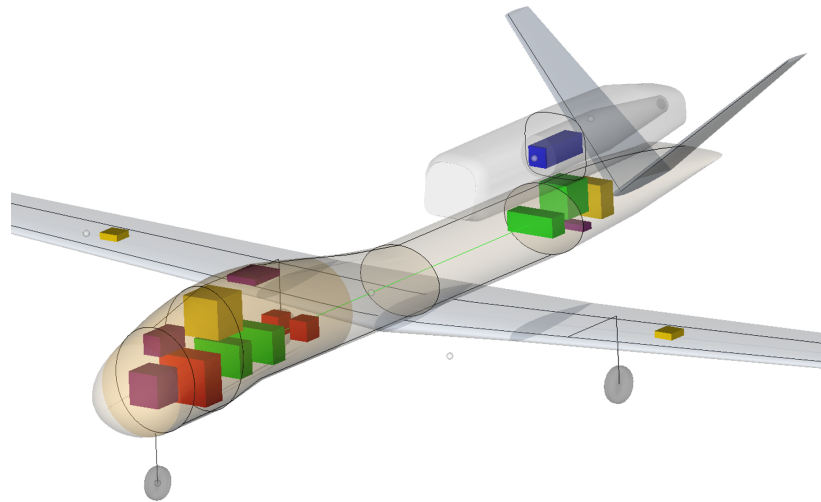

Figure 2.4: Example of geometry model fidelity as used in SE. From Papa-georgiou et al. (2020), used with permission of the author.

For the high-level description of products and the systems they are embedded in, SE uses models focused on the representation of multiple stakeholders’ needs, scenarios, and agents. These are captured in domain-specific modelling languages like systems modelling language (SysML) or unified modelling language (UML) (Osmundson et al., 2006).

According to Friedenthal et al. (2007), “the future of systems engineering is model based”. This entails that all product aspects, stakeholders,

and systems are represented in interconnected models. In theory, these models range in abstraction from operational models down to component models.

The geometry models used by most SE approaches are commonly too abstract for component-design engineering analysis. Examples of this are Papageorgiou et al. (2020) or Li et al. (2020b), which both represent aircraft through multi-disciplinary product models, as shown in 2.4. While such low-fidelity geometry models are sufficient for architectural and system decisions, they are commonly not sufficient for engineering design analysis. However, the use of geometry models with limited feature granularity reduces the computational power required for simulation and analysis.

2.3 Product models

The development of a product is a process of information generation (Ullman, 2003). This information is stored in different types of models, each representing a specific, relevant product aspect. To cite Lindemann (2007), a model is a “target oriented, simplified formation analogous to the original, which allows drawing conclusions based on the original”.

2.3.1 Function models

Function has been identified as the driving force behind a product and its form. Therefore, Umeda and Tomiyama (1997) state, “functional reasoning technology is indispensable [...]”.

One of the more traditional function models is the “black-box” modelling approach proposed by Pahl et al. (2003), which represents a function “as a transformation of states”. On this view, a function transforms flows of energy, materials, and signals. The basic modelling element of a “function”, which can be decomposed into similar elements representing less complex functions, is illustrated in Figure 2.5.

Over the years, multiple function-modelling approaches have been developed, for different purposes:

- functional decomposition of existing designs for the purpose of systemic analysis or illustration (Albers and Sadowski, 2014; Gericke and Eisenbart, 2017)
- concept generation (Helms and Shea, 2012; Jin and Li, 2007)
- product and manufacturing platform, SBCE (Landahl and Johansson, 2018; Levandowski et al., 2014)
- physics-based reasoning (Mokhtarian et al., 2017)

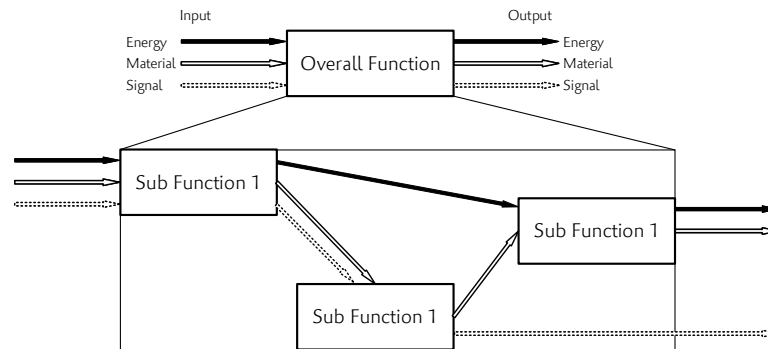

Figure 2.5: Function as a transformation of states, modelled as a “black box” with input and output flows of energy, materials, and signals. Redrawn after Pahl et al. (2003).

However, even though many of these modelling approaches have been validated in engineering design contexts, they are not widely used outside of academia: “Typically, industrial practitioners do not regard function modeling as something very useful, particularly, for the purpose of design.” (Tomiyaama et al., 2013). The combination of ambiguity of methods, the level of abstraction required for most methods, and the additional effort apparently are too big hinders for function modelling to be an applicable method in conceptual product development.

Enhanced function-means modelling

Enhanced function-means (EF-M) modelling is used to express a product’s design rationale (DR) through functional requirements (FRs) and their respective design solutions (DSs). It allows for the representation of alternative product configurations and analysis of systemic product properties of the individual product concepts.

An EF-M model captures a product’s DR, to which it is possible to associate design parameters (Malmqvist, 1997). This DR is represented in a tree-like structure based on Hubkas’s law 1988, decomposing a product into sub-functions and their respective sub-solutions. The alternating function and solution objects are commonly labelled following the functional basis using *verb + noun* pairs (Hirtz et al., 2002). The respective modelling elements are shown in Figure 2.6.

Following Suh’s axiom of independence (Suh, 1990), the cardinality of an is solved by (isb) connection between a FR and a DS is 1 : 1. However, multiple DS can be modelled for a single FR; in that case, they represent

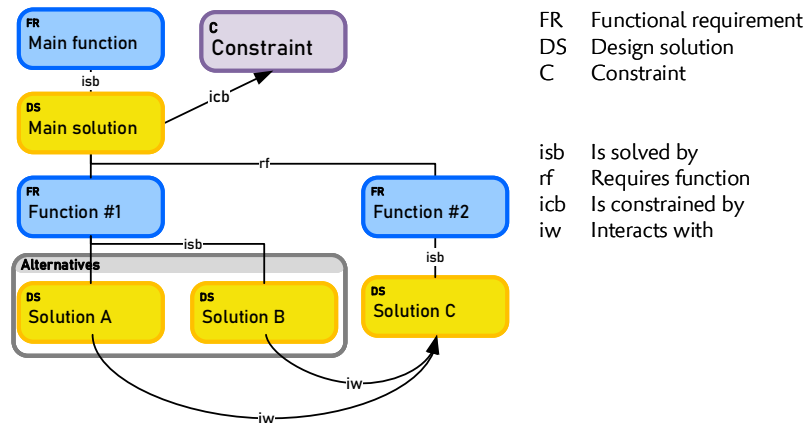

Figure 2.6: Modelling elements of enhanced function-means modelling, based on Schachinger and Johannesson (2000).

alternative solutions – such as DS_a and DS_b in Figure 2.6. Through this, EF-M allows for the representation of product platforms (Johannesson et al., 2017) or DSE (Levandowski et al., 2014).

Beyond functions and their solutions, EF-M modelling can represent constraints (Cs) on the design. These can limit the design parameter (DP) of a DS to certain values or windows. These are modelled relative to individual DS.

The EF-M tree can be viewed as being separated into different levels (Levandowski et al., 2014). The main product functions in the top row constitute the static level, while the lowest level, where functions and solutions close to the embodiment are situated, is referred to as the concrete level. The conceptual level, connecting the former two, is where the product is developed into its sub-solutions.

An EF-M model can be used for decomposition and extension of an existing design as well as for greenfield development. In the first case, it is commonly built bottom-up from identifiable solutions, while in the second it is created top-down beginning with the overall product functions.

2.3.2 Geometry models

Originally, computer-aided design (CAD), the de-facto standard modelling approach for product geometry, was intended to simplify the generation of product drawings (Kasik et al., 2005). These systems were line-based and aimed to produce product representations that could be used

in the manufacturing process. However, even in the early days of CAD, high hopes were put on the emerging technology in terms of automation and geometry optimisation (Voelcker and G. Requicha, 1977).

In today's CAD systems, a product's geometry is defined through mathematical definitions of points and curves in the three-dimensional space \mathbb{E}_3 . The curves are formed through transformations of or through points in \mathbb{E}_3 , such as non-uniform rational B-spline (NURBS), a highly controllable, parameterised version of B-splines which has emerged as one of the standard tools in CAD (Hirz et al., 2013). From these curves, surfaces can be constructed, which can be combined to solids. These solids are used to represent the product's geometry and as a basis for subsequent product analysis.

For the representation of product shapes with multi-dimensional curvatures, such as aircraft or automotive exteriors, *surface models* are used. Surface models require less resources to generate and use as basis for analysis. However, for volume-based product behaviour analyses, *solid models* are required (Hirz et al., 2013). Since such analyses are required for the evaluation of aircraft engine components, this thesis only considers solid CAD models.

Designers interact with these mathematical definitions through a user interface (UI), which lets them manipulate control points of the above mentioned curves, the parameters defining their dimensions and the relations between them. The CAD software interface is defined to reduce the need for an understanding of the mathematical basis of CAD to a minimum. CAD users mostly interact with *features*, which are collections of geometric elements with defined interfaces. Examples of this include *sketches*, *extrusions*, and *revolutions*.

Parametric design

To simplify variation of existing CAD models, *parametric CAD* separates the geometric data from the governing dimensional parameters (Camba et al., 2016). Beyond this, modern CAD systems also allow for the association of CAD data not only between different geometric objects, but also different modelling files (Hirz et al., 2013). This allows for connected assembly structures, where changes in parameters propagate through the geometry of the entire product structure.

However, the creation of such parametric models is "a big challenge" (Li et al., 2020a). Furthermore, The creators of the model need to anticipate all possible changes of the model beforehand. The parameterisation needs to be performed in a way that both enables the desired changes in ge-

ometry and maintains the model’s robustness. As a result, “a parametric model offers little flexibility” for the introduction of design solutions once the parameterisation has been performed (Li et al., 2020a). If these models are to be altered for new DS anyway, most modelling approaches are “prone to modelling errors” (Camba et al., 2016), due to a lack of consistent modelling practices, the complexity of relations in a master model and ambiguous feature definitions. These modelling errors may often lead to failures when regenerating the model after changes have been made (Camba et al., 2021; Kasik et al., 2005; González-Lluch et al., 2017).

2.4 Design space exploration

The *design space* is a theoretical construct that describes the number of all possible designs (Saxena and Karsai, 2010). It is bounded by *constraints*, which describe limits to certain properties (behaviour or design parameters) that the products are not allowed to exceed. In most product development approaches, these constraints are captured in the product’s requirements. Inside these boundaries, the design space can be populated with countless *concepts*, each of them fulfilling the requirements, but potentially with different qualities and behaviour.

The extent of the design space is vast—to cite Woodbury and Burrow (2006), “hyperastronomical in extent”. Hence, there are multiple approaches to exploring the concepts residing in it. Examples include SBCE (Sobek et al., 1999) or simulation driven design (SDD) (Sellgren, 1995), which prescribe a strategy for DSE in the product development process. These approaches can employ different methods, based on different product modelling approaches. The following section presents a selection of *function-modelling-based* and *geometry-modelling-based* DSE approaches.

DSE using function modelling

Function modelling “addresses solution finding early in the process and on an abstract level.” Eisenbart et al. (2012). This is due to function modelling being able to clearly define the design space, simplifying the introduction of novel solutions, and making possible analysis at an early phase. As a result, there are many function-modelling-based DSE approaches; this section presents a selection.

Borgue et al. (2018) use the explicit constraint modelling of EF-M to define the design space in a redesign project for additive manufacturing (AM). As a result, designers know which areas of the design are to be changed and which are to be kept the same. Furthermore, through the representa-

tion of the DR, the function model communicates *why* the relevant areas are to be altered or not.

The Integrated Function Modelling (IFM) framework as presented by Eisenbart et al. (2015) offers representation of the product in multiple, function-based matrices. IFM enables analysis of system properties of the product, using, for example, a design structure matrix (DSM).

Dimensional analysis conceptual modeling (DACM), developed by Mokhtarian et al. (2017), supports “incremental innovation” through “physics-based reasoning”. The DACM approach is based on bond graphs, somewhat similar to the “black box model” presented in Figure 2.5. The approach makes use of intricate variable mapping within the product model, which enables the physics-based analysis. This allows for an assessment of product concepts in the early phases of development.

The Hierarchical Co-Evolutionary Design (HiCED) design approach by Jin and Li (2007) populates the design space with functional concepts generated by a genetic algorithm that traverses the design space by “zig-zagging” between functions and solutions, similar to Suh’s (1990) axiomatic design. Helms and Shea (2012) use an object-oriented graph grammar based on FBS by Gero and Kannengiesser (2004) to explore alternative configurations of products. The approach maintains physical integrity through the modelling of connections between different product modules, and therefore enables a high level of automation.

In general, almost all function-modelling-based DSE approaches lack coupling to geometry models. The lack of a representation of the product’s geometry hinders the analysis of important product behaviour, and therefore of whether the concepts reside within the design space. Furthermore, several studies have reported a challenge for function modelling at the high level of abstraction at which the product is represented (Tomiya et al., 2013; Vermaas and Eckert, 2013).

Design automation

Since CAD models are the backbone of product development for mechanical products but are challenging to edit (Kasik et al., 2005), extensive investments have been made in research and development on automating generation and variation of these models. This automation has been done in the first place to reduce the amount of repetitive routine tasks and free resources for more creative tasks (Hopgood, 2001) but has also found its

way into the toolboxes of DSE.

Parametric CAD is among the most common approaches for generating a variety of CAD models. Multiple approaches exist, differing mainly on how the master model is parameterised and how the parameters are stored and managed. One example is the generative design approach presented by Krish (2011), which employs a genetic algorithm to generate alternative parameter values, and from that alternative geometry models. Parametric DA approaches are often coupled with automated multi-disciplinary analysis (MDA) frameworks, such as presented by Sandberg et al. (2011). This combination enables the exploration of a wider area of the design space, while generating product knowledge.

The generation, capture, and storage of product knowledge is a core element of knowledge-based engineering (KBE) (Stokes, 2001). Through their high level of DA, KBE systems support the automation of repetitive tasks as well as multi-disciplinary optimisation (MDO) (La Rocca, 2012). Some KBE approaches aggregate the product behaviour knowledge of multiple variants to generate *meta models*. These models interpolate the design space between the simulated concepts and therefore allow for a more holistic exploration of the design space. However, the design space that these meta models represent is bound by available CAD models.

Most KBE approaches share the same limitation: they operate in a design space predefined by the master model, which makes introducing novel design solutions and concepts difficult.

Other DSE approaches use *feature databases* or design repositories to combine existing modules into new concepts. These are similar to “design catalogues”, which are also suggested by Pahl et al. (2003), with the added help of DA. Omidvarkarjan et al. (2020) proposes such an approach, which provides a web-based interface supporting the assembly of CAD models from adaptable features.

3

Research approach

It is widely argued that engineering design lacks sufficient scientific foundation.

John R. Dixon 1987

While as old as the author of this thesis, the statement above is still considered valid by many. Several works have discussed the need for design research to be scientific (Blessing and Chakrabarti, 2009) and how to achieve a sufficiently scientific level of practice. Research in the engineering design field is not only understood as a pursuit of scientific knowledge—it also pursues the goal of improving engineering and design practice (Eckert et al., 2003). The following section describes the nature of EDR between scientific research and practical application, based on literature about and from the domain. The second section introduces different research methodologies that have influenced the research approach presented in the third section. Lastly, the methods used for data collection and processing are presented.

3.1 Between science and engineering

Engineering design research (EDR)¹ has been defined as “the study of principles, practices and procedures of design” (Cross, 1984). As such, its

¹Different authors of different publications have referred to the subject in different terms, such as engineering design research, design research or even design methodology (although distinct from design methodologies). However, for this publication the term engineering design research (EDR) has been chosen.

topic can be distinguished from that of the “natural sciences”, since EDR studies “the artificial”—how to create new artefacts—and not, like physics, chemistry, or biology, processes observed in the natural environment (Simon, 1996).

As stated by Eckert et al. (2003): EDR has “the dual goal of providing understanding of designing as a phenomenon and to improve to process that it is studying.” Therefore, the contributions of researchers in EDR also have to focus on how the design process and the respective design activities can be improved. Ullman (2003) states that an estimated 85% of product development projects encounter problems in cost or time management or by simply not functioning as intended—so there might be room for improvement.

As a result, there is a vast host of methods and methodologies in engineering support that have been developed through EDR. While the definitions of these terms may be debated, in this thesis they are used as follows:

- A *method* is a “systematic procedure with the intention to reach a specific goal”², following the definition presented by Pahl et al. (2003).
- A *methodology*, as distinguished from a method, are “various methods [...] brought into a logical connection” (Hubka and Eder, 1988) - therefore can a methodology make use of several methods, or methods can be arranged in a methodology (Estefan, 2008).
- A *tool* (the use of which might be required for the application of a certain method) is a “working aid” (Birkhofer et al., 2002), which may be developed in tandem with a method, but might also be used in other contexts. Tools can be realised in different forms, for example physical (such as hammers, whiteboards, or excavators) or as software (such as CAD software, MS Word, or Skype).

However, the appreciation of design methods in industrial application varies, as is shown in the following quote from a design methodology newsletter:

“If you call it, ‘It’s a Good Idea To Do’, I like it very much; if you call it a ‘Method’, I like it but I’m beginning to get turned off; if you call it a ‘Methodology’, I just don’t want to talk about it”

Alexander (1971)

²Translated from the German: “planmäßiges Vorgehen zum Erreichen eines bestimmten Ziels”

These resentments do present a challenge for the introduction of methods (and even more so methodologies) in industrial practice and the subsequent contribution of EDR to engineering design.

3.2 Research methodologies

To counter the critique of the scientific qualities of EDR, several researchers have suggested research methodologies and approaches to guide (especially PhD student) researchers in the field. Among the most common methodologies applied these days is the design research methodology (DRM) as presented by Blessing and Chakrabarti (2009). Together with the *spiral of applied research (SoAR)* (Eckert et al., 2003) and the *journey to validation* (Isaksson et al., 2020), it has formed the research approach followed in this thesis.

3.2.1 Design research methodology

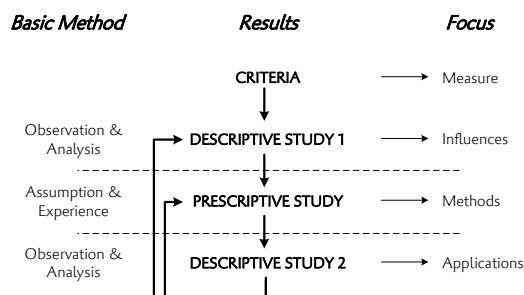

Figure 3.1: Illustration of the DRM framework, reproduced following Blessing and Chakrabarti (2009)

DRM was developed specifically to give long-term research projects, such as the research leading to a doctoral thesis, a scientific structure. The methodology, devised by Blessing and Chakrabarti (2009), describes a series of studies and how to perform them in order for EDR “to become an established area of scientific research”. The phases of DRM and their connections are illustrated in Figure 3.1. The methodology is centred around the definition of measurable criteria, which are established through an initial literature review. The state of these criteria and the status quo of engineering practice is observed in a descriptive study one (DS1). A prescriptive study (PS) then prescribes a new method, methodology, or tool meant to improve this status quo, in effect hypothesising that “this

method/methodology/tool will improve engineering research”, along the lines of in Reich (1995). The improvement, and with it the hypothesis, is then evaluated in a descriptive study two (DS2). Only through a precise definition of *criteria*, and comparison of their values in DS1 and DS2, can the “hypothesis” of improvement of design practice be evaluated. However, DRM does not focus on hypothesis falsification, actually not even on the concrete formulation of a hypothesis—DRM focuses on the improvement of design practice in a structured way, and a well-structured documentation of it (Blessing and Chakrabarti, 2009).

3.2.2 The spiral of applied research

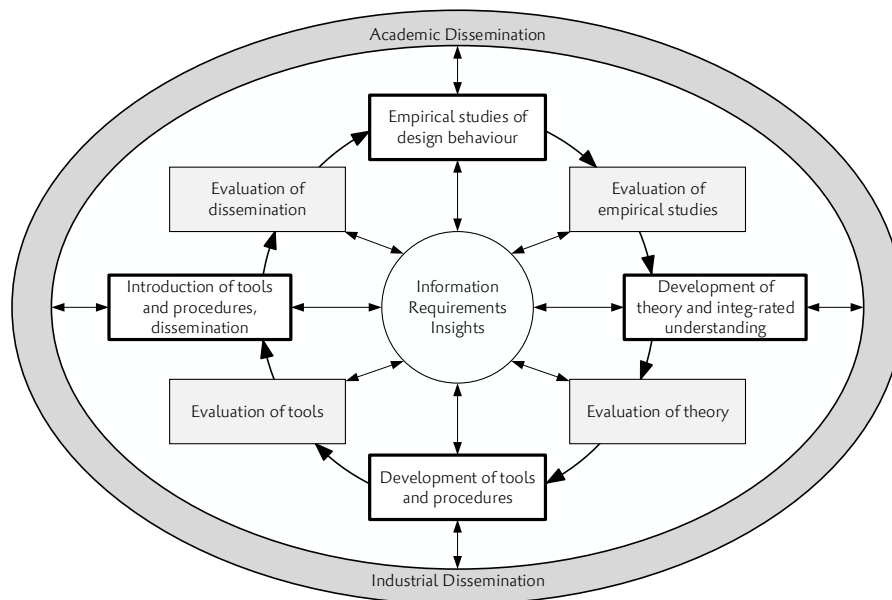

Figure 3.2: An illustration of the spiral of applied research, reproduced following Eckert et al. (2004).

While Blessing and Chakrabarti (2009) puts the focus on measurability and a clear ordering of related studies, other research methodologies focus on the duality of EDR. In part, this stems from a critique of the search for “quantitative metrics”. Eckert et al. (2004) states that complex behaviour such as design can hardly be measured quantitatively. The choice of the measure, the relationships between different measures and outcomes (causality), and the generalisability of it are “tricky” in choice and, potentially, ill-defined (Eckert et al., 2004). As a solution to this, Eckert

et al. (2003) suggests a circular view on EDR: the SoAR, depicted in Figure 3.2, with four main research activities and four corresponding evaluation stages. All of these are based on a core set of information, and all relate equally to the dual evaluation framework of academia and industry.

3.2.3 Validation in engineering design research

According to Popper (2002), it is not possible to *validate*³ a hypothesis—or any research related to it. A hypothesis can only be “falsified”, which has to be attempted repeatedly. Only if repeated attempts to falsify the hypothesis fail, does its *verisimilitude* increase, i.e., the probability that it is true. For the *research claim* presented in this thesis, however, *testing* instead of falsifying it, as prescribed by Gero and Kan (2016) or Reich (1995) for EDR, is seen as sufficient for validation.

To justifiably claim to have produced knowledge, as well as having improved an engineering design practice, the researcher needs to answer to the question “Are you doing the right research?” (Le Dain et al., 2013). This includes whether the research *solves* a problem, whether this problem actually *exists*, and whether it is *relevant* to the field of research. But beyond the validity of the research topic and questions, the proposed solution also needs to be valid, that is, it needs to be “useful[.] in respect to a purpose” (Barlas and Carpenter, 1990).

Often used in a similar context, *verification* instead relates to whether a construct or model *is consistent in itself*⁴ (Barlas and Carpenter, 1990). In ISO 9000 validation and verification are defined as:

- Verification: Activities conducted to ensure that the design output meets the input requirements (functional requirements and specifications).
- Validation: Activities conducted to ensure that the resulting products meet the requirements for the specified application or intended use (customer needs)

Following these definitions, a research claim has to be *validated*, and the method supporting it has to be *verified*.

Since EDR aims to contribute to two different goals, the research also has to be subject to two types of validation: while the academic results need to be valid in terms of methodical data collection and evaluation, the industrial side requires the methods and tools that are developed in the

³Popper actually says “verify”, see Footnote 4.

⁴These definitions are borrowed from the modelling literature. In traditional academic philosophy, the definitions of *validation* and *verification* are reversed.

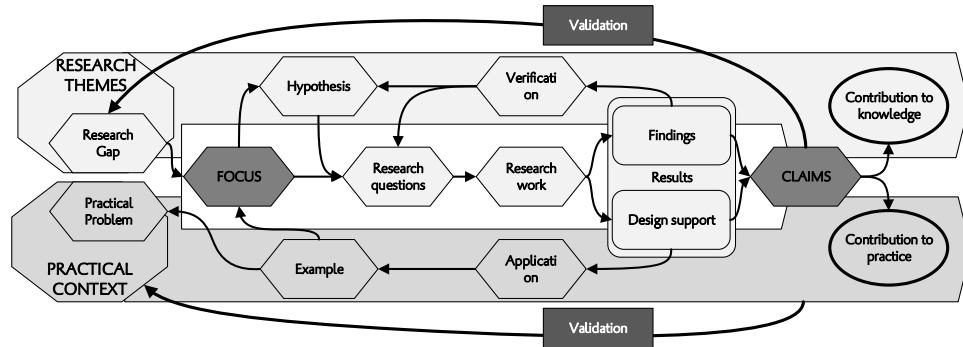

Figure 3.3: “Journey to Validation” redrawn following Isaksson et al. (2020)

course of EDR to be powerful, reliable and validated (Eckert et al., 2003). This is illustrated well in the “Journey to Validation” by Isaksson et al. (2020)⁵, shown in Figure 3.3.

3.3 Applied research framework

As is common for EDR, this thesis follows a two-fold approach, contributing to the body of knowledge about engineering design and improving the applied practice of the discipline.

Therefore, the presented research has been performed in close collaboration with three partners from the Swedish aerospace industry. The main collaborator, here typically referred to as “the case company”, is a tier-one supplier in the aerospace propulsion supply chain, developing and manufacturing structural aircraft and engine components, as well as propulsion systems for spacecraft. The two other companies develop and manufacture satellite and spacecraft components.

This collaboration has allowed for insight into the engineering design practice, the problems that arise, and the need for design support. The collaboration also provides a test-bed for the verification of the approach, as well as for validation of the approach in an applied engineering environment.

The research activities in this thesis are contextualised in a research framework that collects research questions, related research activities, and the order of these processes. The framework, which is illustrated in Figure 3.4, is inspired by the notion of a “Journey to Validation” by Isaksson et al. (2020), and has been adapted drawing on DRM (see Section 3.2.1) and the

⁵For which the current author performed data collection.

3.3. APPLIED RESEARCH FRAMEWORK

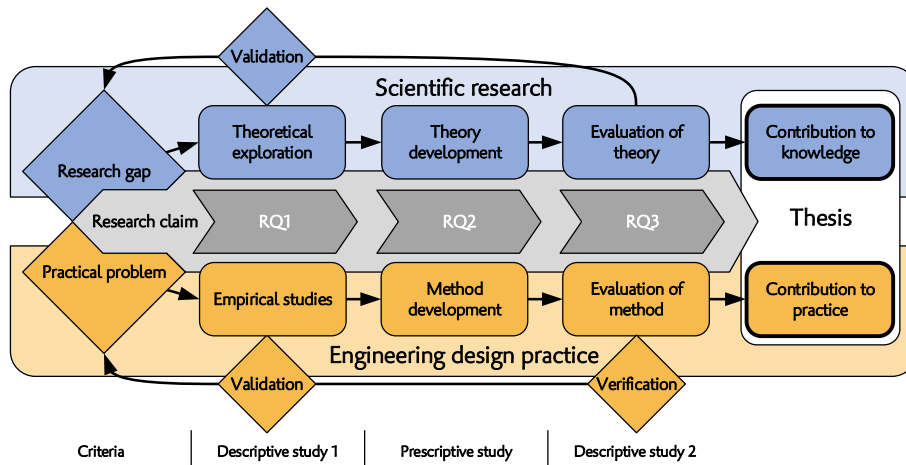

Figure 3.4: An illustration of the research process this thesis applies, showing the interrelation between the scientific aspects of EDR at the top and the engineering practice at the bottom, with the corresponding goals of contributing to knowledge and to engineering practice.

SoAR (see Section 3.2.2).

The research claim, stated in Chapter 1.2.3, forms the centre-line that the thesis follows. This claim is based on the identified research gap and the practical problem faced by the industry, and offers a solution to both. Research activities are performed in both the scientific domain and to engineering design practice; these activities correspond roughly to the three research questions. The identification of the initial research gap and practical problem and the distinction between the scientific domain and industrial domain follow Isaksson et al. (2020). The research activities, which are based on the SoAR, are grouped in three main phases, each one focused on answering one research question. These three main phases of activities, together with the identified research gap and industrial problem, are similar to the phases of DRM, see Figure 3.4. The research activities ultimately lead to this thesis, which represents a contribution to academic knowledge and a presentation of a design support method that improves the applied product development process.

The theory and method developed are validated in their respective domains. The contribution to practice is first verified in a laboratory environment and then validated through empirical studies in the engineering design context, assessing how well presented approach solves the practical problem. The contribution to knowledge is validated through a literature, evaluating how well it closes the identified research gap.

The following section elaborates on the thesis research methods and how they interact with each other.

3.4 Adopted research methods

The entire research leading to this thesis covered a period of five years and four research projects⁶. All of these projects were carried out in collaboration with one or more companies from the aerospace sector; one specific Swedish aerospace supplier, “the case company”, was a major partner in each research project.

Initial studies

An initial literature study was performed in parallel with observations at the case company to explore the research gap. Further motivation and focus for the investigation came from earlier work by the author, such as in Heikkinen and Müller (2015); Isaksson et al. (2016). As proposed in both the SoAR and DRM, the research in academic literature and the observations of engineering practices influenced each other, as illustrated by the overlap of the respective diamond shapes in Figure 3.4. Through this, a “recognition of a theoretical problem” and “observations or preliminary studies” were both achieved, letting the efforts conform to the initial step for scientific research as prescribed by both Popper (2002) and EDR (Reich, 1995). The results of these initial studies, namely the identified research gap and industrial problem, laid the foundation for the subsequently posed research questions.

Theoretical exploration

An additional literature study was performed to investigate the research gap and find potential solutions among already developed work. The results of the study represent the knowledge base for the respective research fields presented in Chapter 2. This knowledge forms the *paradigms*—i.e., the framework of concepts, results, and procedures (Kuhn, 1970)—that the research claim builds on. As such, it provides the basis and background for all appended papers.

The literature research was focused on product modelling approaches for DSE from both an engineering design and a systems engineering point of view. While Paper B and Paper C directly present results of the literature

⁶VITUM, DINA, and MEPHISTO, financed through VINNOVA, and RIQAM, funded by the Swedish National Space Agency.

research, all other publications also build on the results of the theoretical exploration.

Empirical studies

To explore the industrial situation, several case studies were performed with industrial partners. In these case studies, the researchers participated in and observed practitioner activities, investigating product development practices (Yin, 2006). The studies involved approximately 10 workshops with over 50 different practitioners from multiple different companies in the Swedish aerospace industry. Details about the workshops are presented in Paper A and Paper D. The author was also regularly present at one of the case companies' research and development offices for over two years, participating in daily work routines such as team meetings.

The insights gathered through observations and workshops were enhanced through interviews with the practitioners. In some cases, workshops or interviews were preceded or followed by questionnaires, to extend the qualitative data collection with more quantitative data.

The empirical studies and the "theoretical exploration" contributed the majority of the answers to RQ1.

Theory development

Building onto the empirical data from the observation studies, combined with the knowledge base from the literature review, a theory about the coupling of function and geometry to improve design practice was developed.

The theoretical framework and method have been developed in parallel, following a loose interpretation of the spiral development approach (Boehm, 2000). The framework provides the basis for the DSE method that seeks to alleviate the challenges documented in the empirical studies.

As a result of the theory development, and as an answer to RQ2, a model for improved DSE, combining function modelling with geometry modelling, emerged. The model, the *object model for function and geometry (OMFG)*, is published and explained in Paper C and Paper E. It is described using UML and a custom, multi-dimensional graph.

Method development

Based on the challenges and opportunities identified in the literature review and empirical studies, a "scenario of the desired situation" (Blessing and Chakrabarti, 2009) is developed, along with a method to realise that

situation. Method and theory development were performed in parallel and influenced each other. The developed method is a *prescriptive* result from the developed theory about how to improve product development, defined in a DSE method: *function- and geometry-exploration (FGE)*.

The needs and requirements for this method are sourced from the empirical studies at the different companies. The method was developed in an iterative process through feedback loops with the practitioners. This method builds on the knowledge basis established in the literature review, and makes use of the features and qualities of suitable product modelling approaches, such as EF-M and CAD modelling.

The model describes in detail the *input, context, tools used, and expected outcome* of the method, complying with the call for clear method description by Gericke et al. (2017).

Evaluation of theory

The theoretical model developed connects the two dimensions *function* and *geometry*. Two research activities were performed to evaluate the proposed model which connects of these two product modelling domains.

First, a benchmark of the functional decomposition was created, following the *Function in Engineering* benchmark by Summers et al. (2013). To create this benchmark, the theoretical aspects of the approach were in the focus, and practical aspects of the method such as user interaction, integration and visualisation were left out (Bracewell et al., 2001). The benchmark is published in Paper C.

The second research activity supporting the theory is the automated embodiment of design concepts. The automation was verified with a prototype of a software tool. This tool is described in Chapter 4.2.2, and the related study is published in Paper E.

Evaluation of method

Since “it is difficult to assess the effectiveness of a computational method in a practical sense without creating a reasonable prototype system” (Bracewell et al., 2001), a software tool was developed as a proof-of-concept. This tool, the object model for function and geometry based design space exploration (omfgDSE), allows for experimental testing of all three modules of the method with user groups. The omfgDSE tool is a server-based application providing a UI through a conventional web-browser, realised using SQLite, Python Django, JavaScript, HTML, and CSS. This allows for users of different operating systems to access the tool without any prerequisites. Furthermore the setup allows for user studies

through online workshops (as was necessary at times due to the Covid-19 pandemic). Lastly, it allows users to access the tool without having to install local software components, which is often denied due to a company's information technology (IT) security policies.

The *decomposition* and *innovation* modules of the method were tested in two workshops each in two different research projects. The workshops were attended by domain experts, developers, and managers. The workshops were closely monitored by the participating researchers, and the results captured in the form of mind maps and photographs. The practitioners' feedback was captured through observation, interviews before and after the workshops, and questionnaires. When the omfgDSE tool was used for workshops, user interactions with the tool were logged through the tool.

These methods, along with "Evaluation of theory", lead to the answer to RQ3.

3.4.1 Verification and validation

The research was validated by answering the question "are you doing the right research?" (Le Dain et al., 2013). The validity of the research gap was shown through a comparison with research challenges named in the literature, whereas the industrial challenge was validated through the results of the above listed empirical studies, and published in Paper B and Paper C.

The proposed method has been verified—making sure it meets the requirements— through a proof-of-concept tool. The related study is published in Paper E.

The validity of a model or method is assessed by its "usefulness in respect to a purpose" (Barlas and Carpenter, 1990) – meaning how well does it solve an actual world problem? It is assumed that the validation of the industrial challenge as well as the research gap as stated above proves them to be "actual world problems". A study with practitioners investigated how well the proposed FGE method alleviates the problems, with the practitioners confirming that the identified problems were indeed real. Through a workshop, the method was applied to a product development project at the conceptual product development phase. The results of the validation study are presented in Paper F.

4

Research results

*Though our smoke may hide the heavens from your eyes,
It will vanish and the stars will shine again,
Because, for all our power and weight and size,
We are nothing more than children of your brain!*

Rudyard Kipling

from: “The Secret of the Machines (Modern Machinery)”, last stanza

To be able to explore more, and more novel, product concepts, a product’s functions, solutions, and geometry need to be represented in a way that allows each of these aspects to be varied. Hence, a product development method has been developed that allows for the introduction of novel functions and solutions. The method, function- and geometry-exploration (FGE), supports the exploration of alternative product concepts in both the functional and geometric domain.

The following chapter presents the FGE method, the underlying object model for function and geometry (OMFG) and the research leading to its development and validation.

4.1 Summary of appended publications

The main contributions of this thesis are published in six academic publications appended in the second part of this thesis. A summary of relevant parts of each publication follows below.

4.1.1 Paper A: Connecting functional and geometrical representation to support the evaluation of design alternatives for aerospace components

Paper A contributes to the thesis with an investigation into the challenges of applied DSE, focusing on the investigation of new solutions for an existing product structure. EF-M is used as an efficient method for exploring alternative solutions in an already existing product architecture. However, the results highlight the need for the generation of CAD models for concepts explored in the functional domain.

This publication presents a report from an exploratory design study. The prescribed goal of the study is to explore novel and radical solutions for an aeroengine component, a TRA. The challenge was to evaluate these novel and radical concepts against the legacy design, even though they showed such a wide difference in technology, TRL, and product knowledge.

The challenges associated with introducing novel design ideas into an established product architecture are described in Isaksson et al. (2016), Paper [i]. The publication reports on the initial phase of the study, naming the goals of “function platform modelling”, “modelling [...] of [...] alternative options” and “evaluation through simulation” for the study. Paper A reports on how well these goals have been achieved and the further challenges that arose.

Novel solutions and functions for the TRA were collected in ideation workshops with product developers from the participating aerospace manufacturing company and captured as DSs and FRs in an EF-M model. The EF-M model allowed for a clear representation of the alternative functions and solutions. Furthermore, it allowed the *legacy design* to be captured in the same model, which is important since the new concepts need to be evaluated relative to the legacy model.

For the evaluation of the concepts relative to each other, a VDD approach was pursued. The VDD approach allowed for the capture and representation of different stakeholder needs and for weighing them against each other.

In order to assess the stakeholder needs, so-called “engineering characteristics” of each concept need to be evaluated. A set of these can be analysed from the EF-M model, for example using DSM. Among these characteristics are complexity, modularisation potential, and grade of novelty. Simulation of other product properties, such as aerodynamic, structural, or thermodynamic behaviour, requires CAD models. To enable the simulations, the EF-M model, and the DPs stored within, were

4.1. SUMMARY OF APPENDED PUBLICATIONS

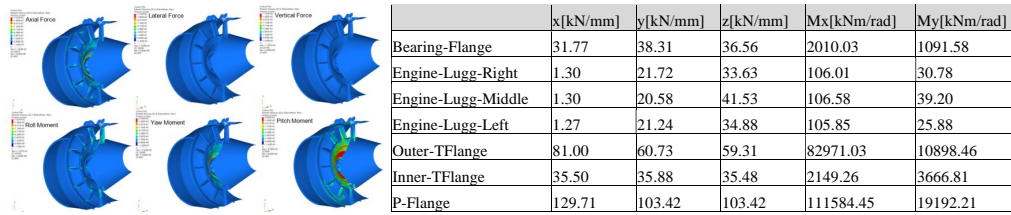

Figure 4.1: Stress analysis illustration and numeric results for loading of bearing flange of exhaust cone in a TRA design with 14 vanes. Simulations were performed by RISE IVF.

connected to parameterised CAD models via a spreadsheet routine. This enabled the parameterised variation of an existing master model. However, the geometry models for *conceptually different* concepts had to be created manually. As a result, only three different concepts could be evaluated in the VDD approach. The three concepts, and the results of their stress analyses, are shown in Figure 4.1.

The use of EF-M proved to enable “systemic knowledge capture” and representation of the different design solutions—independent of the TRL—and their relations to the product’s architecture. However, only three of the 1080 theoretically possible concepts could be fully evaluated due to the challenges of embodiment. The use of a parameterised CAD model was not sufficient, and the developers had to resort to manual CAD manipulation.

4.1.2 Paper B: Lessons learned from the application of a function-means modelling method

Paper B contributes to this thesis with a literature-based motivation for the use of EF-M for DSE. The function-modelling approach is – from a literature point of view – well suited for the representation of the design space, capture of novel design solutions at arbitrary abstraction levels, and systemic product analysis.

EF-M is a function-modelling method developed at Chalmers University of Technology. Strengths and challenges associated with EF-M were identified by analysing past research projects.

Among the strengths, presented in Table 4.1, are most characteristically for DSE the ability to “keep an open design space”, “support simultaneous top-down and bottom-up modelling” and “support modularisation”. These strengths result in EF-M *enabling the easy introduction of new design solutions at any level of abstraction*. This makes EF-M fit for capturing innovation, and for first-order evaluation.

	EF-M Benefits	Derived from:
B1	Holds an open design space	Set-based engineering (Sobek et al., 1999)
B2	Supports modularisation	Break down into sub-problems (Pahl et al., 2003; Suh, 1990)
B3	Enables systemic product behaviour/property analysis	Explain behaviour, working principles (Tomiyama et al., 2013)
B4	Captures and stores design rationale	Presentation of purpose (Tomiyama et al., 2013)
B5	Provides a parametric bandwidth	Set-based engineering (Sobek et al., 1999), exploration of alternatives (Kang et al., 2011)
B6	Supports simultaneous top-down and bottom-up modelling	Different levels of abstraction in functional decomposition (Eckert et al., 2012)
B7	Filters design alternatives through constraint employment	Generation of valid concepts only (Kang et al., 2011)
B8	Captures variable design information	Interorganizational communication purposes (Tomiyama et al., 2013)

Table 4.1: Benefits of EF-M modelling of use for DSE.

The challenges of EF-M match the general challenges for function modelling as presented by Tomiyama et al. (2013). The greatest challenge for DSE appears to be the lack of a connection between the design rationale represented in the EF-M model and the geometric product representation, i.e., the CAD model. As shown in Paper A, geometry models are needed for a subsequent analysis of the product's behaviour, which in turn is required for a fact-based evaluation and selection of concepts.

4.1.3 Paper C: Enhanced function-means modeling supporting design space exploration

Paper C presents the theoretical concept of the FGE approach, proposing to couple function and geometry modelling into a combined DSE approach. This approach is then compared to other, function-modelling-based DSE approaches from the literature.

Building on the findings of Paper A and Paper B, this paper proposes a DSE approach that enables concept representation in both the functional and geometric modelling domain.

The paper explores the abilities of EF-M modelling to represent a legacy design and its extension through novel DSs. The paper investi-

gates a model of a glue gun, based on the function-modelling benchmark proposed by Summers et al. (2013).

The glue gun is captured in EF-M through functional decomposition. Beyond the mere DR in the form of FR, C and DS, the EF-M model captures product *function* and *behaviour* parameters such as dimensions, temperatures, and voltages. This is done for the legacy concept and for the new solutions, which change the architecture from a wired to a battery-driven glue gun, as shown in Figure 4.2. These parameters are then used for an initial analysis of the two product concepts. This is similar in concept, although not extent, to the *physics-based reasoning* that can be seen in other function-modelling approaches, cf. Mokhtarian et al. (2017).

The DSE approach has been generalised into the *function- and geometry-exploration (FGE)*¹. The strengths of EF-M modelling, as presented in Paper B, make it a suitable centrepiece of the DSE approach. The approach is explained in detail in Section 4.2.1.

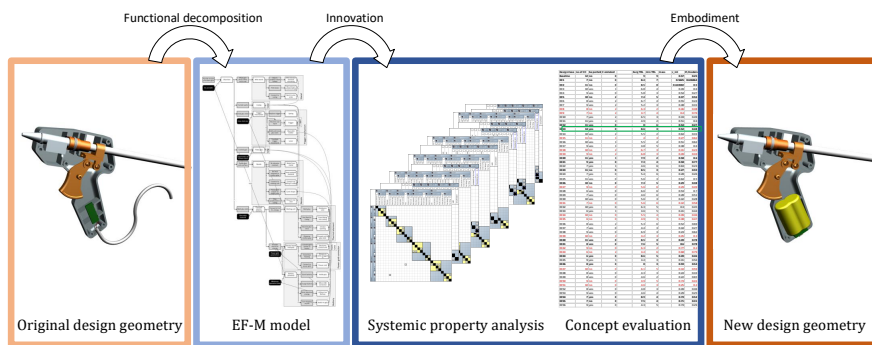

Figure 4.2: Visualisation of the concept evaluation process. EF-M model containing all variants, DSM derived from the EF-M model, table of 56 concepts and evaluation criteria, renderings of legacy and selected concept.

FGE is benchmarked with relevant DSE criteria based on Summers et al. (2013). The presented approach stands out as one of the few keeping an open design space, enabling the comparison of multiple concepts in the same model.

However, the approach presented in Figure 4.7 relies on a coupling of the function model to the geometry model, which enables an automated—or at least less resource-intensive generation of CAD models of the individual concepts. This coupling is not presented in Paper C, but identified as a challenge for further development.

¹However, the actual name *FGE* was introduced after the publication of Paper C.

4.1.4 Paper D: Mapping the design space in function and geometry models for re-design for AM

Paper D contributes to the validation of the decomposition stage of the FGE approach, and defines further criteria for the embodiment. It illustrates how EF-M—and therefore FGE—enables the representation of a product’s design space and capture of product knowledge and thereby supports a more structured DSE. Lastly, it shows the flexibility of the chosen function-modelling approach by extending the definitions of constraints into manufacturing (C_m) and functional constraints (C_f).

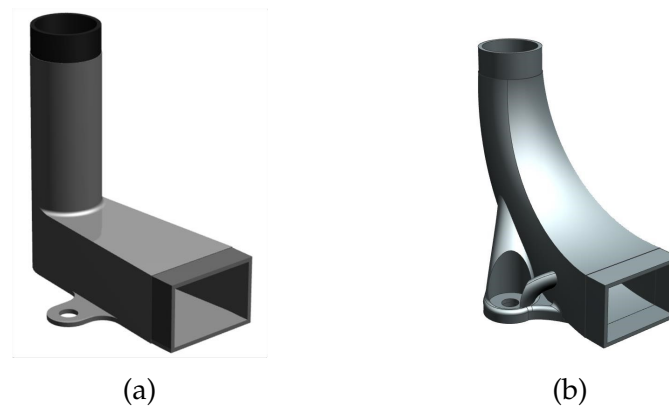

Figure 4.3: The flow connector substitute product for the publication; (a) the legacy design and (b) the redesign for AM.

Building on the FGE approach presented in Paper C, this publication sets out to explore how well the function model can be used to represent and populate the design space.

The functional decomposition and innovation steps of the FGE method were performed in collaboration with design teams from three aerospace companies. Each of the companies participating in the study had one rocket or satellite component to be redesigned for AM. The study was performed using the companies’ real components, to protect the companies intellectual property (IP), but a substitute part that accumulates the most relevant geometrical and functional challenges was devised for the publication. This part, the “flow connector”, is based on functions and requirements which are typically found in satellite components. Figure 4.3 presents the flow connector in both its original and redesigned version.

With the aim of redesigning existing components for AM, the legacy design was decomposed into EF-M models. A special focus was put on identifying and capturing constraints, which then were distinguished

4.1. SUMMARY OF APPENDED PUBLICATIONS

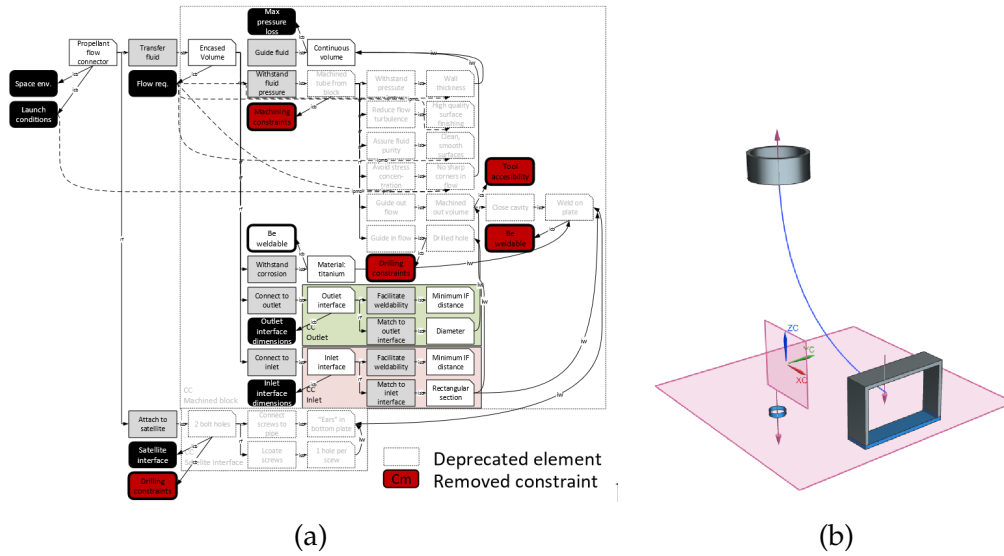

Figure 4.4: The functional (a) and geometric (b) design space after being pruned from relevant manufacturing constrained (respective C_m are highlighted in red in the function model) elements.

as *functional constraints* (C_f s) and *manufacturing constraints* (C_m s). This provides a clear overview of the areas, in terms of both functions and solutions, of the design that are affected by the change in manufacturing. Together with the elements of the EF-M model coupled to the geometry, this provides a clearly defined design space. Figure 4.4a shows the design space representation in the functional domain, and Figure 4.4b shows the geometric design space—after removal of all geometric elements that were constrained by C_m related to traditional manufacturing methods.

Interviews with practitioners confirmed the usefulness of the design-space representation through the coupled function model and geometry model. Practitioners felt supported in their decisions about *what to redesign*. However, the practitioners did struggle with the abstractness of the function-modelling approach in the decomposition phase, cf. Tomiyama et al. (2013).

The design of the flow connector was verified through test prints at Chalmers University using fused deposition modelling, cf. Borgue et al. (2019) (Paper [vii]).

4.1.5 Paper E: Function model based generation of CAD model variants

Paper E presents an implementation and application of the FGE approach with the object model for function and geometry (OMFG). The connection between function modelling and geometry modelling is presented in the OMFG. The decomposition, design, and embodiment stages of the approach are demonstrated on a TRS.

The previous publications have described the FGE approach, and how to apply it. Paper E presents a realisation of the approach in the form of an object model which enables the application of FGE. The object model describes how function and geometry elements are to be linked to each other to enable the automated generation of CAD models of different concepts captured in the functional domain.

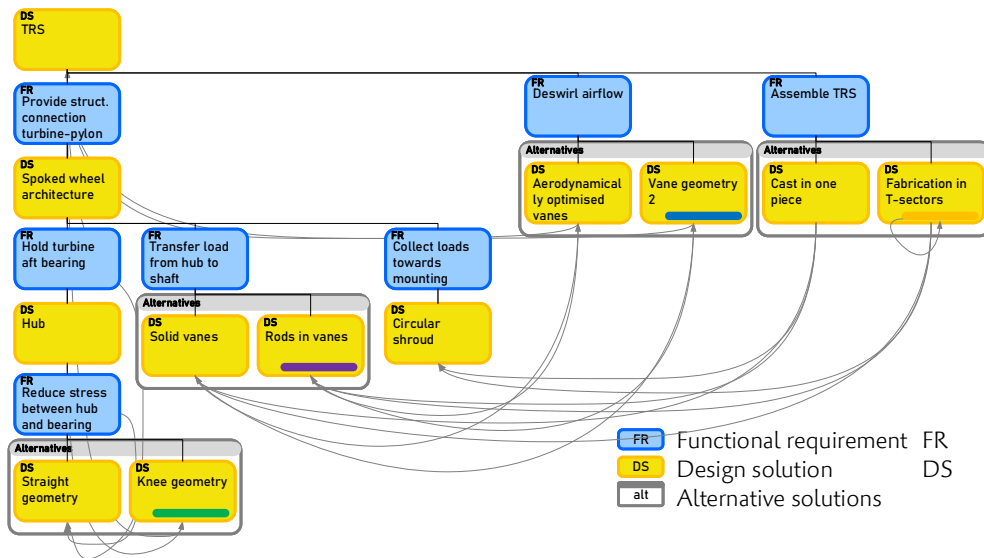

Figure 4.5: EF-M model of a TRS with alternative DSs for four FRs. The UDFs for the alternative DSs have the same colour coding in Figure 4.6.

The OMFG enables the capture of all relevant elements of both EF-M and CAD modelling, as well as the necessary connections between them. This builds onto the previously proven (Paper A, Paper D) geometry-based functional decomposition of the product into EF-M

Based on the product architecture captured in the function model and the linking to both interfaces and parameters, the assembly algorithm can generate CAD models of all concepts instantiated from the EF-M model. Through the concept of *alternative interfaces*, the user defined features (UDFs) of alternative DSs can be placed in a new context without

4.1. SUMMARY OF APPENDED PUBLICATIONS

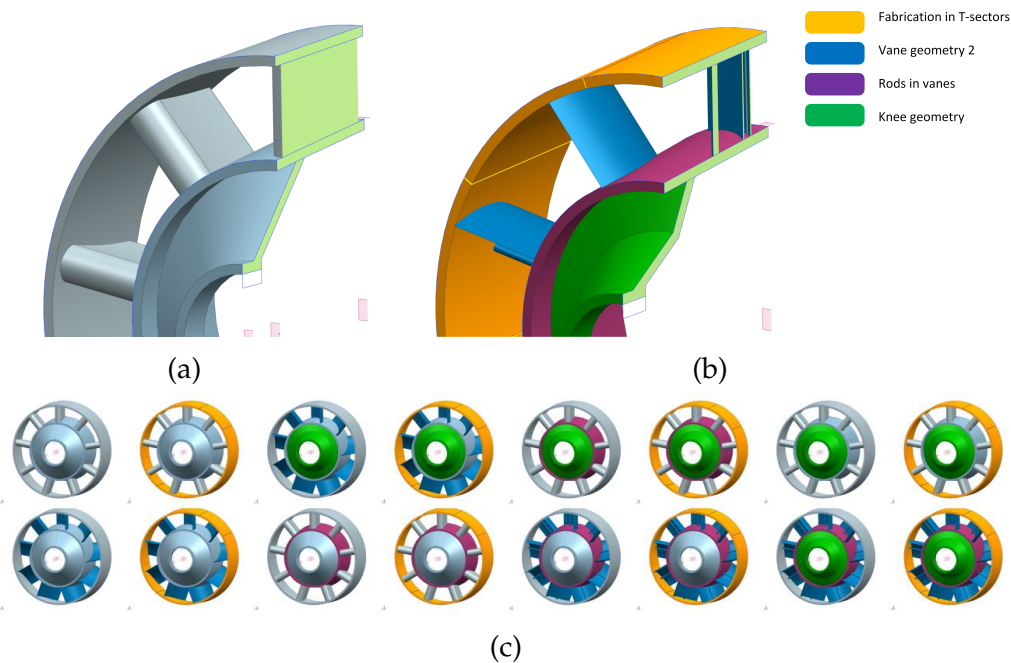

Figure 4.6: Geometry models of the TRS, created through the proof-of-concept tool omfgDSE for FGA. (a) Section through the the legacy design, and (b) concept 16 which is composed of only the alternative solutions. (c) CAD models of all 16 instances.

individual re-linking of the interface objects.

The OMFG is presented in detail in Chapter 4.2.2.

A proof-of-concept tool omfgDSE was developed to demonstrate the functionality of the object model and approach. The web-server-based tool enables function modelling, function-geometry linking, and DA for the generation of CAD models of alternative concepts. A TRS, based on data from the study reported in Paper A and Paper [i], has been modelled as a legacy design. Alternative solutions for four different functions have then been introduced into the function model, and their geometries integrated into the OMFG. This is illustrated in the EF-M model in Figure 4.5, where alternative DSs for four different FRs are captured. The EF-M model furthermore shows the interacts with (iw) connections based on the linked UDFs.

Based on these alternative solutions, 16 different concepts have been instantiated in the functional and geometric domains. Renderings of the sixteen CAD models are shown in Figure 4.6c. The concepts are composed from different features, which are colour-coded in Figure 4.6.

Setting up the approach requires a certain effort, such as for the functional decomposition, geometric-module creation, or linking the modules to and inside the OMFG. However, an approximate computation of effort has shown that the approach is still more efficient than manual CAD-model creation or alteration.

4.1.6 Paper F: Improved design space exploration through function-based configuration of geometrical product models

Paper F validates the FGE approach in an industrial product development project. It is shown that the approach contributes to the exploration of alternative concepts in the development of a guide vane (GV). Practitioners provide feedback and pointers towards further development of the approach.

The FGE approach is put to the test in an industrial product development project. In collaboration with the development team of an aerospace manufacturing company, the FGE approach has been applied in developing a part for a turbofan engine, a fan frame GV.

The decomposition and innovation stages of the FGE approach were applied in two workshops. A combined function and geometry model of the GV was created and expanded with new solutions and functions using the omfgDSE tool.

The practitioners' experience with the approach, their opinions about its usability, and the contribution of FGE to the development process was captured through qualitative data collection methods. While—once again—the abstractness of the function-modelling approach was challenging for some, the use of the online tool was described by others as “very comprehensible”.

The participating practitioners mainly emphasised the opportunity for knowledge capture, representation, and exchange that the method and its application offered to them. The use of the EF-M model illustrated “how [the architecture of the GV] is connected”. They expressed that the application of the method, in the same or future projects, was desirable.

Regarding the purpose of the method, practitioners stated that “generation of CAD models based on different configurations would be a key functionality”. While this only means that there is a *need* for methods like FGE, the general consensus among practitioners was that “this is one possibility to generate, and evaluate, lots of concepts”. An overwhelming majority stated that the application of the approach supported both the introduction of new functions and solutions, many of which they assumed would not have been considered with traditional approaches.

4.2. FGE: FUNCTION- AND GEOMETRY-BASED DESIGN SPACE EXPLORATION

From the statements about knowledge capture and exchange, the number of novel captured functions and solutions and the observation of the practitioners, it can be concluded that FGE improves DSE. This is achieved by providing a more function-oriented perspective onto the product, capturing and presenting it in a respective model and at the same time connecting it to the product's geometry. This could exemplarily be observed in how the discussions of the developers shifted from geometry-based concerns to analysing the actual DR of the product.

Still, participants pointed out specific problems in the function-modelling approach relating to the capture of the DR of highly integrated products. If we abide by Suh's 1990 first axiom "An optimal design always maintains the independence of FRs", a FR can only be solved by *one* DS. However, in real life, product geometry is reused for multiple functions, especially for aerospace structures where weight optimisation is among the highest priorities. Since the chosen modelling approach EF-M strictly follows axiomatic design, such dependencies are difficult to represent.

Another major concern voiced by the practitioners was the quality of the CAD models. They need to be of sufficient quality to be subject to automated meshing routines for finite element method (FEM) based analysis.

4.2 FGE: Function- and geometry-based design space exploration

Function models are able to represent how a product is *expected* to behave, but CAD models are required to analyse how it *will* behave. While an EF-M model "keeps an open design space", most DA approaches determine the search space at the setup of the master model. A function model can represent a product's architecture and DR—*why a product looks the way it does*; a geometry model shows how the architecture is realised—*how it looks*.

Based on these complementary qualities of the two very different modelling approaches, a combined function- and geometry-modelling-based design space exploration approach—FGE—was developed. It combines the ability to describe the design space and to populate it. It supports the introduction of novel design concepts at arbitrary levels of abstraction, and enables their realisation in geometry models with reduced effort. It represents the legacy design and novel functions and solutions in one and the the same model. It enables the capture and representation of teleological, architectural, and geometric knowledge.

The FGE approach builds on the connection between the two modelling domains. This connection is facilitated through the object model for function and geometry (OMFG) which connects individual solutions in the form of DSs from an EF-M model to their geometric instances. Together with the capture of the geometric connections and DPs in the EF-M model, this allows for a seamless, automated embodiment of alternative product concepts into CAD models.

The FGE approach was developed during five years of research at Chalmers University of Technology. It builds on the established function-modelling approach EF-M and UDFs in the CAD software Siemens NX with the Python application programming interface (API) NXOpen. The approach was verified and validated in three different studies in collaboration with companies from the aerospace sector. These studies have validated the individual stages of FGE using a proof-of-concept tool in a laboratory environment.

4.2.1 The function- and geometry-modelling-based design space exploration approach

The FGE approach allows developers to investigate novel solutions for the development of a new product. Following common practice in most product development projects, the approach assumes the existence of a legacy design from which the development process can start. The FGE approach can also be performed as a green-field design approach, through a top-down development process, starting with the main functions of the product. However, this thesis explains the more common approach, which builds on the geometry model of an existing legacy design.

In the context of FGE, DSE is split into three main phases: *decomposition*, *innovation* and *embodiment*. These three phases are illustrated in Figure 4.7a.

In a first step, the legacy design's DR is captured through a functional decomposition into an EF-M model (process (1) in Figure 4.7a). This function model acts as the basic representation of the design space, illustrating constraints based on different stakeholders and how they impact the individual design solutions. The EF-M model allows for capturing of all available product knowledge, be it in the form of behaviour, function, or design parameters. The decomposition process, how to capture the DR of geometric elements and how to integrate constraints and requirements into the function model, is described in detail in Paper C and Paper D.

Developers can place their novel ideas in this design space—represented by *functions*, *constraints*, and the respective solutions—either as solu-

4.2. FGE: FUNCTION- AND GEOMETRY-BASED DESIGN SPACE EXPLORATION

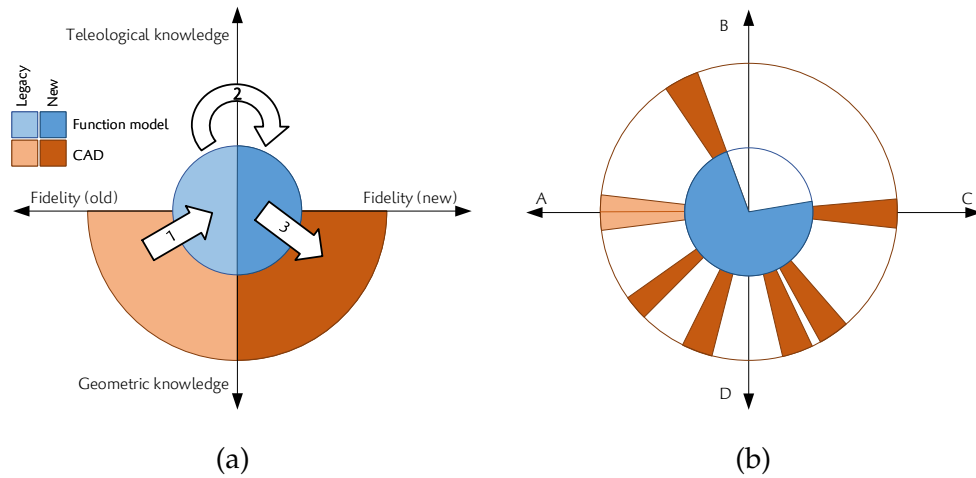

Figure 4.7: The FGE approach. The orange area illustrates the geometric domain, and the blue area the functional domain. (a) The three main steps are (1) decomposition, (2) innovation, and (3) embodiment. The left side represents the legacy design, and the right side represents a novel concept. (b) A top view of the left-hand side (with the left hand being a section through A-C). The coloured areas describe explored sections of the design space.

tions for existing functions or as new functions, extending the product with new functionality (process (2) in Figure 4.7a).

The new solutions identified at the innovation stage have to be *embodied* and their individual geometric solutions linked to the EF-M model. Paper E and Paper F present the innovation phase. The final embodiment phase (process (3) in Figure 4.7a) can be fully automated through the DA approach integrated in FGE, which is presented in Paper E.

Once multiple alternative sub-solutions have been captured, a factorial combination of possible concepts can be instantiated. Figure 4.8 illustrates this for an example with two FR with two alternative DSs each. In the example, the instantiation results in four different concepts, where each possible combination of solutions is present. The concepts are identifiable through a distinct “DNA” of selected solutions, which lists the identifiers of the respectively chosen solutions.

While the 2×2 example in Figure 4.8 is relatively simple to compute, alternative DSs on sub-functions create a higher complexity. The theoretical description of instantiation has been presented by Malmqvist (1997). However, no function for the instantiation of all possible concepts could be found. Therefore, it is presented here as a recursive function in Equations 4.1 and 4.2.

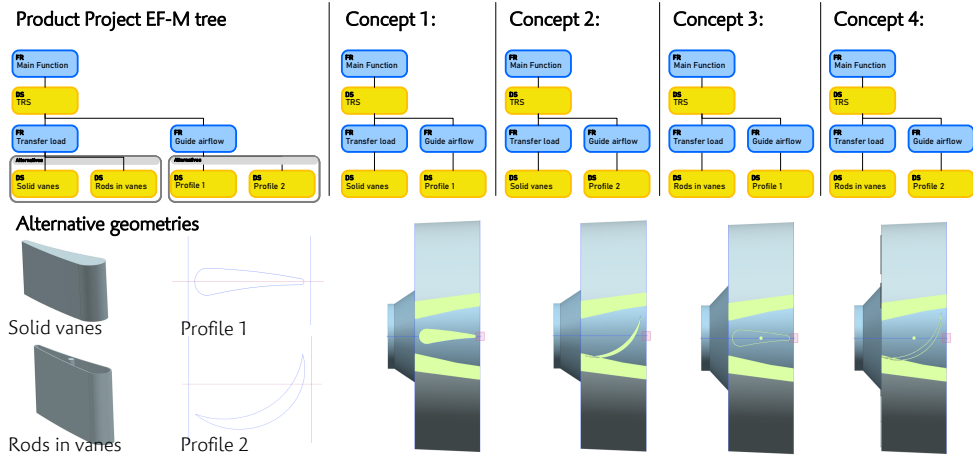

Figure 4.8: Instantiation of a product project with alternative DSs in EF-M and CAD. The upper row illustrates the instantiation in the functional domain, and the lower row shows the geometry models using the respective alternative solutions. The example is based on data from Paper E.

$$n_{\text{concepts}}(\text{DS}) = \prod_{i=1}^{n_{\text{fr}}} \text{altFR}_i \quad (4.1)$$

where recursively for all altFR_i :

$$\text{altFR} = \sum_{j=1}^{n_{\text{ds}}} n_{\text{concepts}}(\text{DS}_j) \quad (4.2)$$

subject to

$$\text{altFR} \geq 1$$

where

$n_{\text{concepts}}(\text{DS})$ = number of sub-concepts of a DS

n_{fr} = number of FRs of a specific DS

n_{ds} = number of DSs of a specific FR

altFR = number of alternative solutions for a function

The number of concepts calculated by Equation 4.1 covers the *modular bandwidth* of the design space. However, each of these concepts, can be varied dimensionally, too, through the implemented parameterisation in DP, DS and UDF.

The concepts can be analysed already in the functional domain for product properties such as modularity, complexity, or other captured

4.2. FGE: FUNCTION- AND GEOMETRY-BASED DESIGN SPACE EXPLORATION

product knowledge. Examples for this kind of systemic analyses are shown in Paper A and Paper C. This enables an initial screening of concepts before they are to be embodied.

Based on the interfaces and parameters, an automated assembly algorithm generates the CAD models for each of the feasible instantiated concepts. The generated CAD models may then be used for engineering analysis of the concepts. MDA approaches such as presented by Sandberg et al. (2011) can use these CAD models to simulate behaviour. The results of these simulations can be stored in the *behaviour parameters* in the EF-M model, associated with each concept. This allows for a systematic evaluation of the different concepts by comparing behaviour and function parameters. Constraint mapping towards behaviour parameters allows for an automated evaluation and verification of concepts.

Once behaviour data has been captured in the EF-M model, individual concepts and solutions can be analysed for their individual as well as combined contribution towards the overall product performance. This allows for an even more detailed investigation into which areas to subject to further improvement and investigation.

4.2.2 The object model for function and geometry

The object model for function and geometry (OMFG) provides a representation for the objects and their relations necessary to enable the FGE approach. The object model is presented as a UML class diagram in Figure 4.9. The EF-M modelling elements DS, FR, and C are captured as objects with the respective *isb*, *requires function* (*rf*), and *is constrained by* (*icb*) links between them. FRs are linked to *function parameters*, which quantify the required function. DSs are linked to DPs and *behaviour parameters*. DP are to be set by the designers and are automatically linked to the geometry model. They can be represented as ranges to explore a dimensional bandwidth. Behaviour parameters are the result of the subsequent analysis process, and enable the evaluation of concepts through comparison with the function parameters. Furthermore, the behaviour parameters can already be used at a pre-geometric modelling stage to capture existing product knowledge, as has been done in Paper C.

The coupling of the function model to the geometry model is realised through the decomposition of the geometry model into feature groups. Each feature group is realised through a UDF. UDFs have been chosen since they make full use of the parametric-associative properties of commercial CAD systems (Hirz et al., 2013), but provide a modular, almost object-oriented approach with clearly defined interfaces. A UDF can con-

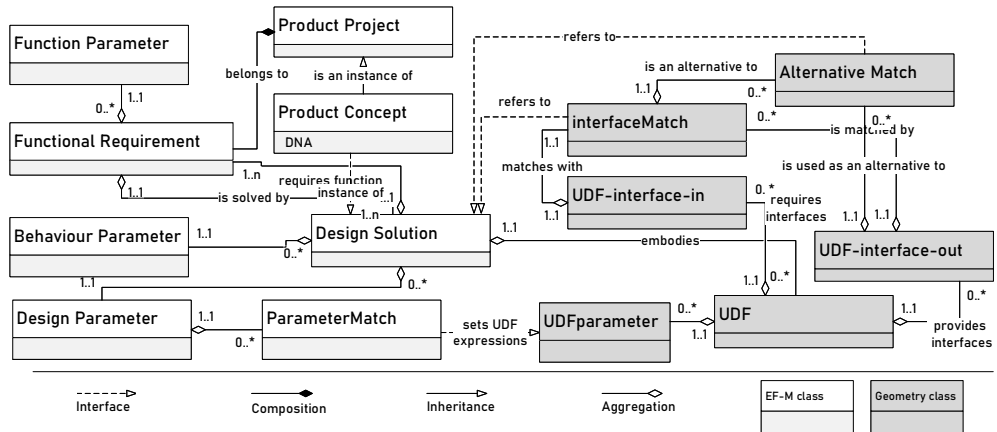

Figure 4.9: UML class diagram of OMFG, as realised in the proof-of-concept tool. Classes in white describe the objects necessary to represent an EF-M model, while classes in grey represent the CAD-related classes. Class properties and functions have been omitted for readability.

tain any type and number of parameterised geometric features and therefore the choice of UDF enables a parametric bandwidth *inside the modular bandwidth*. Furthermore, UDFs as modelling objects are available in most commercial CAD systems. This allows UDFs to be used, created and edited by regular CAD engineers with limited additional training. A UDF object in OMFG contains all geometry elements that are needed to realise the specific function, together with their interfaces and parameters. Each UDF requires interfaces to be placed in a model’s context. These *incoming-interfaces*—denoted *UDF-interface-in* in Figure 4.9—are defined upon creation of the UDF. A UDF may also provide *outgoing interfaces*—*UDF-interface-out* in Figure 4.9, annotated geometric elements, which provide interfaces for other UDF in the assembly context.

An example of this is illustrated in Figure 4.10. The DS “aerodynamic optimised vanes” is embodied by the shape of the vanes. This geometry is defined through the sketch for the vane extrusion. For its placement in the concept geometry, the UDF “Vane1Sketch.prt” requires two points and an axis for placement, which are captured as *UDF-interface-out* objects, illustrated in red. The UDF also provides two *UDF-interface-out* objects for other UDFs to be placed upon: the dimensional place feature “VaneSketchPlane” and the sketch geometry “VaneGeometry1”. Furthermore, the UDF is parameterised via six different parameters, which enable a further bandwidth and adjustment of the geometry.

To enable the DA approach, OMFG automatically reads the UDF once

4.2. FGE: FUNCTION- AND GEOMETRY-BASED DESIGN SPACE EXPLORATION

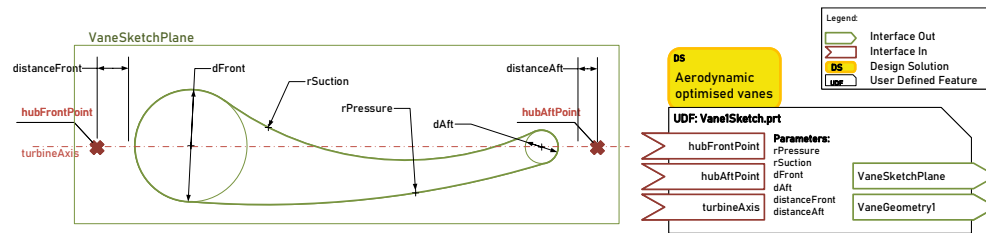

Figure 4.10: Illustration of the UDF “Vane section”, embodying the DS “Aerodynamic optimised vanes” in a TRS and its respective geometry (a sketch), outgoing (green) and incoming (red) interfaces and parameters.

they are associated with a DS, and generates the respective interface and parameter objects in the object model. However, the interfaces have to be matched manually once to place the geometry in relation to the existing product architecture. In the example of the vane-sketch UDF in Figure 4.10, this means that for each of the three *UDF-interface-in* objects “hubFrontPoint”, “hubAftPoint” and “turbineAxis”, the respective *UDF-interface-out* objects have to be matched from the existing geometry. The geometry-based interfaces are then represented as iw connections. These iw connectors can be seen between the DS in Figure 4.12 and 4.5.

Alternative interface matches—*Alternative Match* in Figure 4.9—enable the exchange of UDF for variant designs. The outgoing interfaces of a UDF are in case of substitution replaced with the alternative interfaces of the novel UDF. Alternative interfaces are set when introducing a new UDF into the OMFG. Hence, on integrating the UDF from Figure 4.10, the UDF-interface-out objects “VaneSketchPlane” and “VaneGeometry1” would have to be set as *alternativeMatch* to the interfaces they replace. This limits the need for interface matching, when introducing novel solutions, to the *incoming interfaces* for the geometry of the new solution. Once a DS and its related UDF have been placed in the model, there are no further alterations to be done, no matter how many new objects are inserted.

After the instantiation of the individual concepts from the alternative solutions, each concept is embodied. The assembly process, presented as a UML activity diagram in Figure 4.11, places the individual UDF of each concept into an individual part file. Each UDF then goes through the placing algorithm, which first reads the incoming interfaces, i.e., the ones required to place the part, from the EF-M model. The data consistency towards the EF-M model is checked, i.e., whether all parameters are available and all interfaces are matched. If not, the part is marked as failed and

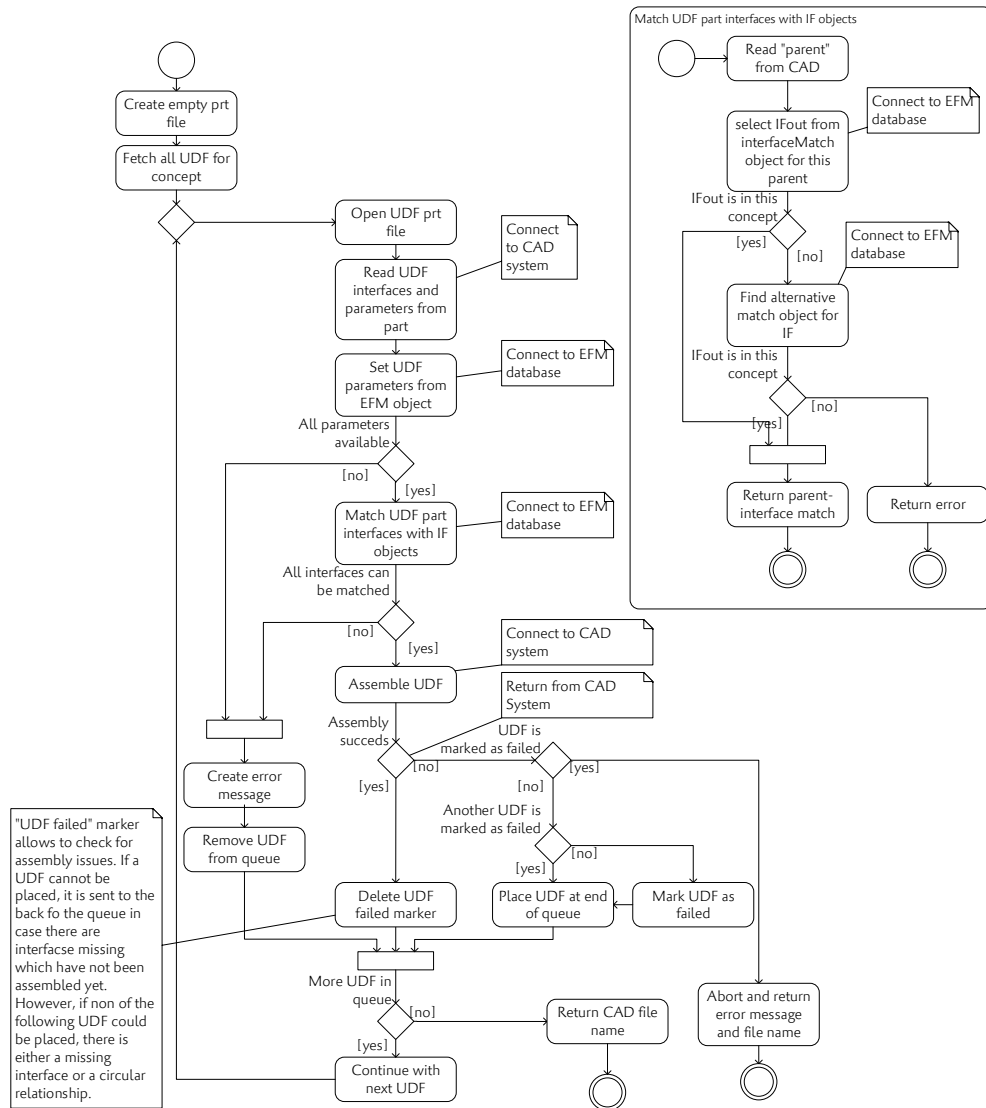

Figure 4.11: UML process model of the assembly algorithm as implemented in the FGE proof of concept tool.

put aside for error reporting. Since all interfaces are matched in the EF-M model, either directly or via alternative interface matches, the algorithm then searches for the corresponding geometry elements in the part file. After the UDF of all DS have been placed, the CAD model of the concept is returned to the EF-M model and associated with the respective *product concept* object.

Should the assembly algorithm fail to generate a concept’s CAD model, this can be seen as an indicator of the infeasibility of designing or producing the concept due to the incompatibility of the respective sub-solutions

4.2. FGE: FUNCTION- AND GEOMETRY-BASED DESIGN SPACE EXPLORATION

in the geometric domain. Human error, such as interface mismatches, problematic parameterisation, and imprecise CAD modelling, may cause such failure, but once these can be dismissed, the assembly algorithm acts as a gate keeper that automatically filters out infeasible concepts.

Realisation in a proof-of-concept tool

The FGE approach has been realised in a server-based tool, the omfgDSE. The tool is operated through a web interface, enabling a collaboration on the same product model among multiple users at different locations. The web interface is shown in Figure 4.12.

The tool implements the OMFG as shown in Figure 4.9. The object model has been realised using Django and a SQLite database with a JavaScript front end, using the Python-based NXOpen API to automate the CAD software Siemens NX. This tool has been used to verify the DA approach and assembly algorithm, as well as to validate the decomposition, innovation, and embodiment phases of the approach.

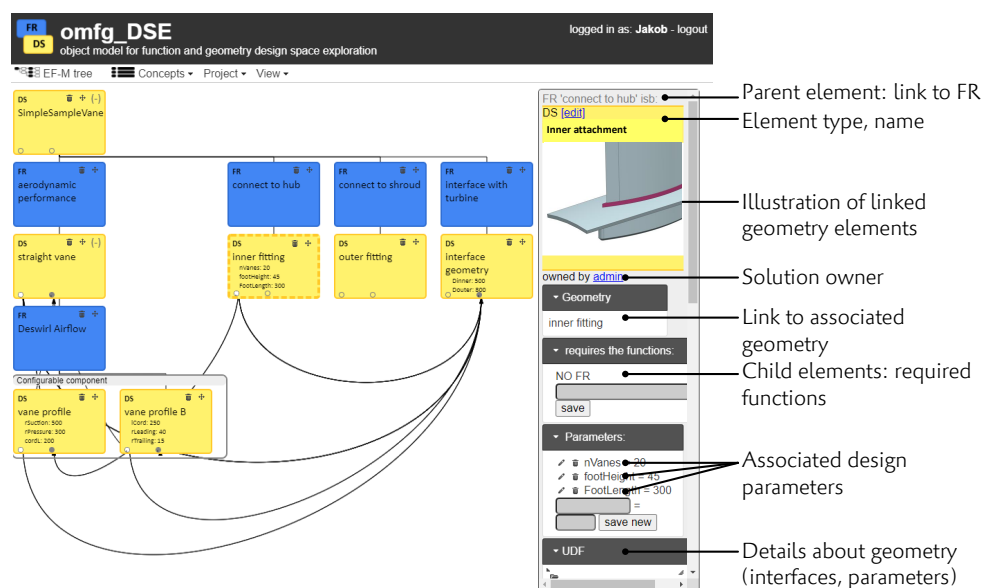

Figure 4.12: Web-based interface of the FGE tool “omfgDSE”, showing a simplified EF-M model of a GV. The right-hand window pane illustrates the details of the DS “vane profile”, such as associated geometry and design parameters.

The tool provides a functional EF-M modelling environment, enabling the modelling of both FRs and multiple alternative DSs. DSs can be equipped with parameters and linked to geometry elements in the form of

UDF. UDF interfaces and parameters can be linked via a graphical UI. An instantiation algorithm generates all individual concepts. Each of these concepts can automatically be embodied based on the data captured in the EF-M model through the assembly algorithm shown in Figure 4.11.

While the generation of the UDF elements requires the use of CAD—in the form of Siemens NX—by the user, all other functions can be performed through the UI and are then executed on the server. No local CAD installation is required, even for the execution of the assembly algorithm.

For the purpose of validation studies, user-activity tracking was implemented, capturing which user is generating and manipulating the objects in the database. This feature was used in the study presented in Paper F.

Although FGE considers the automated MDA and feedback of behaviour parameter values, this has not been realised in the omfgDSE tool.

4.2.3 The FGE approach applied

The different phases of the FGE approach have been tested in multiple case studies. Figure 4.13 shows an IDEF0 process diagram of the application of the approach. Two studies were performed in industrial collaborations, in the context of development projects of aerospace components. These two studies are presented in Paper D and Paper F, respectively. The studies applied the *functional decomposition*, *geometrical modularisation*, and *redesign* phases of the approach. Furthermore, the study presented in Paper F gathered feedback on the approach in its entirety, and all stages were discussed with the participating practitioners.

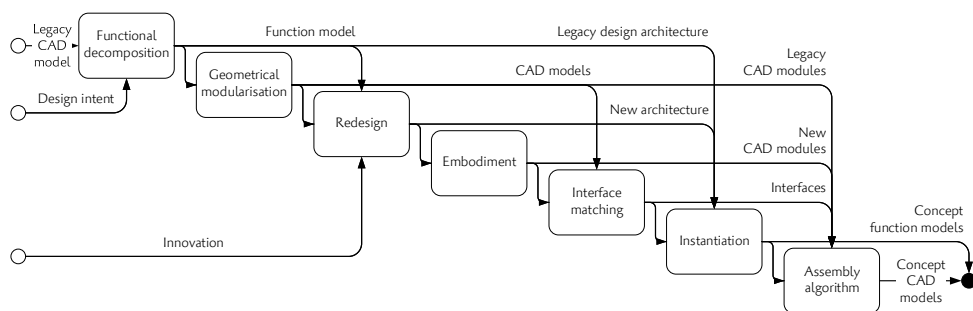

Figure 4.13: IDEF0 process model of the applied FGE approach.

Beyond these applications of FGE, the OMFG was verified together with the related algorithms in a study focusing on the DA aspect of the approach, published in Paper E. This study covered all stages of the

4.2. FGE: FUNCTION- AND GEOMETRY-BASED DESIGN SPACE EXPLORATION

approach but focused on the verification of *embodiment*, *interface matching*, *instantiation*, and the *assembly algorithm*.

All practitioners who worked with the FGE approach appreciated the support in terms of *knowledge capture and representation*. Nearly all engineers who engaged with the FGE approach highlighted the *importance* of such an approach, which describes the design space and can *provide variant CAD models* in the conceptual product development phase. The practitioners stated that the approach supports the exploration of both *more, and more novel, design solutions*. Figure 4.14 shows a selection of feedback from a questionnaire from the study presented in Paper F.

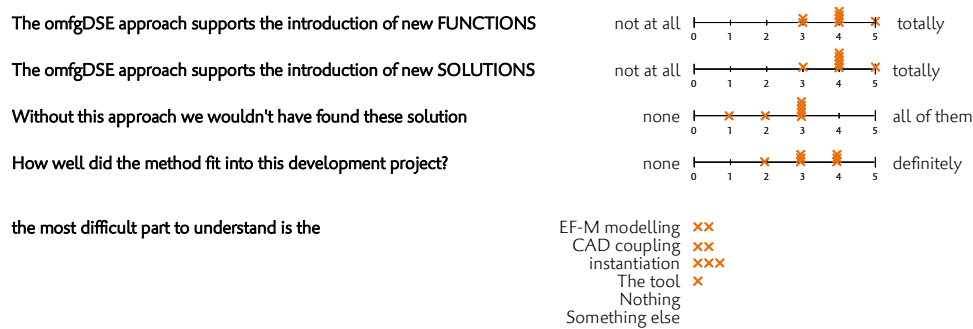

Figure 4.14: Selected answers from the questionnaire after the innovation workshop. Each x represents one answer.

The studies presented in Paper D and Paper F used FGE to represent and populate design space. Both *decomposition* and *innovation* were performed by practitioners. Figure 4.15 shows how a GV was decomposed into UDF, DS and FR, and how the respective geometry elements were associated with DS. As can be seen, DS to UDF is a 1 : n relation, since some design solutions (as long as they have not been decomposed into sub-functions and sub-solutions) may relate to multiple geometric elements.

In both cases, the products were decomposed through multi-disciplinary workshops with engineers and developers from different disciplines. This enabled the capture of functions and constraints that described the entire design space.

Paper D and the corresponding Figure 4.4 illustrate how a design space description using EF-M enables a more systematic search for new solutions. Through the OMFG, the design space description can be presented simultaneously in both the teleological and geometric domain. In the case study, the impact of C_m on the product was represented. As a result, the

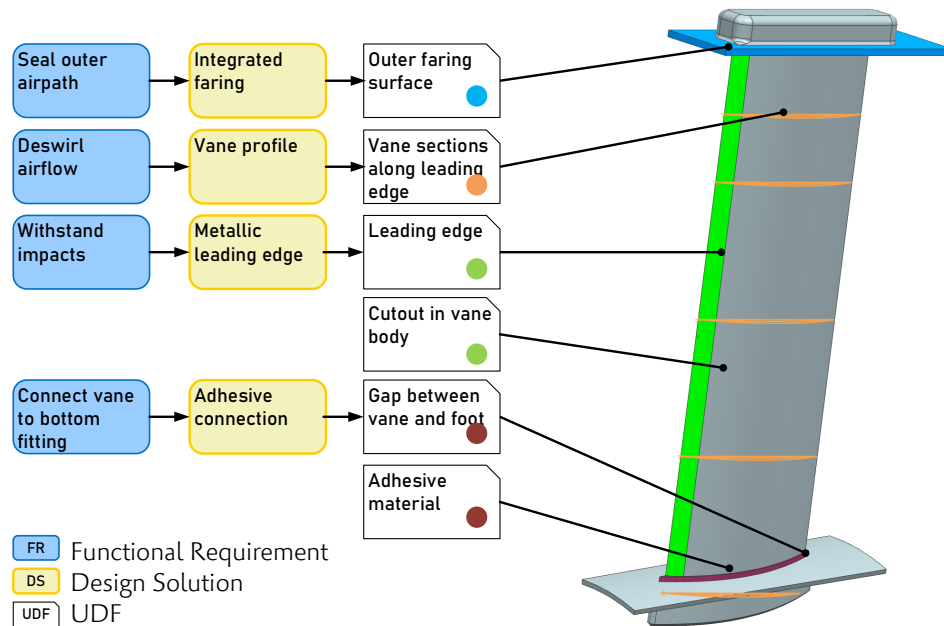

Figure 4.15: A subset of the UDF that the vane has been decomposed into. UDF and geometry elements are colour coded, and the figure only shows a subset of all UDF for the GV.

use of the FGE approach clearly illustrated which solutions, and therefore which geometric elements, needed to be redesigned.

In Paper F, FGE was used not only to *represent* the design space, but also to *populate* it with novel functions and solutions. The degree of novelty of the identified new solutions was determined methodically. Rather, the subjective perception of the participating engineers was used to gauge the effectivity of the approach to capture radically novel solutions. According to this practitioner feedback, which is also presented in Figure 4.14, the approach supports the introduction and capture of novel design solutions as well as functions. This is consistently reflected in the practitioner statements in the studies published in Paper D and Paper F.

While the development of novel functions was investigated specifically, based on the features of EF-M modelling and the observations of the workshops, extending the legacy product's functionality can be performed with the same effort as developing novel solutions. From this it can be concluded that FGE enables exploration of not only a *modular* and *parametric* bandwidth, but also a *functional* bandwidth of the design space.

The ability to represent the design space and capture and represent

4.2. FGE: FUNCTION- AND GEOMETRY-BASED DESIGN SPACE EXPLORATION

novel solutions and functions relative to the product architecture was appreciated by all practitioners interacting with FGE. The generation of CAD models ready for FEM-based analyses was mentioned multiple times; this ability has been highlighted as a crucial requirement for evaluating, and therefore considering, any new solution: the FGE approach was perceived to be “one possibility to generate, and evaluate, lots of concepts” (practitioner quote from Paper F).

The DA element of FGE was applied on a TRS, where four new solutions were introduced. These were modularised and connected using the omfgDSE tool. The relevant EF-M model with the iw connectors computed based on the geometric relations of the associated UDF is shown in 4.5. The assembly algorithm presented in Figure 4.11 automatically generated the 16 different CAD models of all possible variant designs, which are shown in Figure 4.6c.

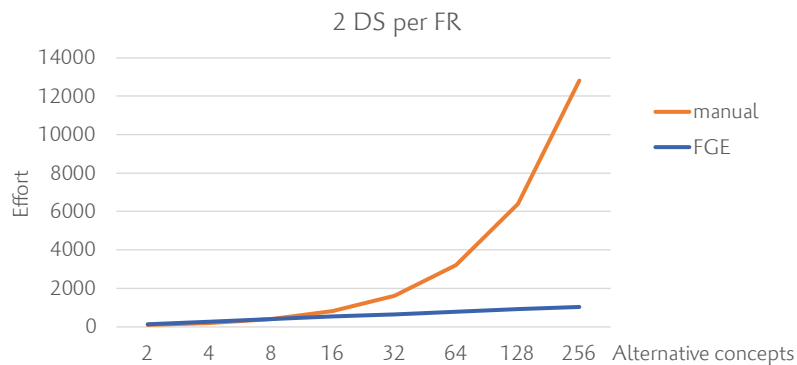

Figure 4.16: Effort to generate all possible combinatorial concepts, either manually (orange) or with the FGE approach (blue).

FGE does not support the *generation of new solutions*; these still have to be embodied manually. However, it does automate the integration into legacy CAD models and CAD models for other concepts. Although this does come at a cost of initial modelling and integration effort, the calculations presented in Paper E point towards a reduced effort for DSE projects that use more than two alternative solutions. This is illustrated in Figure 4.16, which shows the effort associated with generating CAD models for alternative variants using a manual approach and using the FGE approach. Even when assuming high penalties for the integration effort, the use of FGE pays off for more than 5 alternative DS.

5

Discussion

*The ideal thesis should resolve and eliminate its research questions,
and release the mind to do new things.*

Kees Dorst

In design, form does follow function. This has been established in Chapter 1 and has been the premise for this thesis throughout, based on understanding the design process as developing a product to fulfil a function. The goal of the presented FGE approach is to improve this development process by providing a DSE approach that couples these two product aspects: *form* and *function*.

This chapter discusses the degree to which the FGE approach meets this goal, and whether the presented results answer the three research questions posed at the beginning of this thesis, whether the answers are valid, and, if so, how they have been validated. Lastly, the chapter considers the FGE approach in relation to other DSE approaches.

5.1 Answers to research questions

The three research questions, posed at the beginning of the research process, guided the work leading to this thesis. Taken together, the answers to the research questions provide sufficient support for the research claim. Table 5.1 summarises each appended paper's contribution to answering each research question, with the size of the dots representing the estimated size of the contribution.

Publication	RQ1	RQ2	RQ3
Paper A	•		
Paper B	•	·	
Paper C	·	•	·
Paper D	•	·	•
Paper E	·	•	•
Paper F	·	•	•

Table 5.1: Contribution of the appended publications to answering the research questions. Bullet size roughly relates to how much the paper contributes to answering the respective question.

5.1.1 Answers to research question 1

What are the needs for function and geometry models to support the generation and evaluation of a wider variety of concepts?

Research Question 1

The abilities required to enable the evaluation of a wider variety of design concepts in the conceptual phases of product development have been identified as the ability to:

- *represent the design space* with its different constraints and their impacts on individual solutions,
- *capture novel ideas* on different levels of product abstraction in *relation to an existing legacy design architecture*
- *support the embodiment* of the concepts generated from these new solutions, to enable subsequent engineering analyses
- *enable the evaluation* of the concepts, both to verify whether they fulfil the requirements and how well they perform relative to each other.

Paper B and Paper C present the need for a clear *representation of the design space* as a result of literature research. Paper C derives it from the need for successful DSE, and Paper B from the perceived strength of EF-M modelling. The same need—and an initial resolution in the form of the use of EF-M—has been shown with empirical research in Paper D. The capture of different types of constraints and their relations to the different design solutions has provided a better perspective for developers from which to redesign products. Paper F and Paper A also implicitly make use of a clearly defined design space in their DSE approaches using EF-M.

5.1. ANSWERS TO RESEARCH QUESTIONS

The ability to *capture radically new solutions* is the driving force behind the study presented in Paper A. As a result, the data from the paper support the answer to the RQ. The same need is present in Paper D, where a freed-up area of the design space needs to be re-populated with novel design ideas.

The need to build on an existing legacy design is one of the major challenges posed in Paper A; but the exploration of alternatives in Paper C also has to build on an already existing product geometry. In Paper D, capturing and maintaining the functionality of the legacy design and keeping the legacy geometry play an important role. The industrial development project presented in Paper F is also based on a legacy design.

The need for a *direct embodiment of concepts* is apparent throughout the presented papers; the lack of it appears as a definite barrier to DSE in Paper A, obstructing the exploration of further concepts. It appears as a result from the function modelling literature in Paper B and as a DSE requirement, also based on a literature review, in Paper C. It also appears as a challenge and a definite need for a holistic DSE approach in Paper D.

The need for *evaluation* of concepts arises directly from literature, it is even prescribed in the product development according to Pahl et al. (2003): “evaluate based on goals and requirements”. As such it is the underlying reason for the need for embodiment: to be able to evaluate, analysis is needed, and therefore CAD models are required. As such, the need has been prominent in all applied studies, presented in Papers A, C, D and F.

5.1.2 Answers to research question 2

How can novel product concepts be captured, represented, and evaluated in both functional and geometric domains, and how can these two modelling domains be connected to support the automated creation of CAD models from the function model?

Research Question 2

As an answer to RQ2, a DSE method, FGE, has been developed. This method, presented in Paper C and Paper E, combines a function-modelling approach with a module-based DA approach in order to define the design space, populate it in both the functional and geometric domains, and enable the analysis of all generated concepts through the generation of CAD models for each one.

The applicability of the function-modelling approach EF-M for DSE was elaborated in Paper B. Paper C further presents the qualities of EF-M as a DSE method. Paper E presents a full implementation of the FGE approach, which is tested in a laboratory situation.

FGE, as presented in Paper C, builds on a concrete link between a design solution and a set of geometric elements. This link, realised in the OMFG, is presented in the form of an object model. It was implemented in a proof-of-concept tool, which demonstrated in its functionality, in Paper E. The same proof-of-concept tool, in a refined version, was then used in a collaborative industry project to validate the usefulness of FGE, presented in Paper F.

The geometry-modelling side of FGE, as presented in Paper E, enables to link each DS to its respective geometrical elements, together with the respective topological interfaces and geometrical parameters. This provides the basis for an automated assembly algorithm, which automatically generates CAD models of all possible concept instances. While this approach has successfully generated geometry representations of all 16 possible instances in the study presented in Paper E, the validation study presented in Paper F showed that the current implementation of the tool is not yet scalable. However, the assembly algorithm has proven to be able to handle a variety of interfaces, manage the respective geometry-related DPs, and thereby generate CAD models of topographically different concepts.

5.1.3 Answers to research question 3

How does the application of a product development method that combines the product's function and geometry models support the exploration of radically new design concepts?

Research Question 3

Using FGE to develop alternative product concepts enables engineers to capture more, and more novel, product solutions. The approach supports the generation of CAD models of these concepts, thereby enabling the analysis of more concepts, and more varied concepts. The use of the approach supports the capture and representation of product knowledge, both in the teleological and geometric domain. The approach also represents the design space for product developers, which allows for a more systematic design space exploration.

The approach has been used for DSE in an experimental context in Paper E and an applied context in Paper F. In both cases it was shown

to support the exploration of alternative design concepts by capturing individual solutions in a design space described through a function model. These solutions were then instantiated in multiple alternative concepts. Each concept was then embodied in a CAD model, using a DA approach based on modularisation of the geometry model.

Application of the FGE approach in collaborative projects in the aerospace industry has shown that it has the ability to improve DSE. In a case study, the application of FGE has, according to the participating engineers, increased the number of explored alternative solutions and functions. As shown in Paper F, it also increased the subjective *novelty* of the identified solutions and functions. This case study was a practical validation of the theoretically predicted wider DSE as presented in Paper C and Paper A.

Beyond the quantity of new design solutions captured in the study, the approach was also shown to be a more systematic approach to DSE. The capture of solutions and functions as well as their relations in a function model provides an overview of the design space. This enables developers to identify gaps for further development, as was shown in Paper D, as well as the impact of novel design solutions on the existing product as a system.

Beyond the abilities to support DSE, the presented approach also supports product knowledge capture, storage, and retrieval. Therefore, FGE can be described as a KBE approach (Stokes, 2001). Furthermore it fostered a function-based exchange between the practitioners, thereby leading to a more function-oriented product development process.

Since the EF-M model captures the design rationale of a product concept, and represents it in close relation to the respective geometry, it enables a higher understanding of the product as a system. While this helps developers understand their product beyond their respective knowledge domains, as presented in Paper F, this ability provides further support for systematic DSE, as suggested by Cohrs et al. (2014).

5.2 Verification and Validation

As elaborated in Chapter 3, this thesis follows two goals: to improve product development practice and enhance knowledge about the process. This has led to the research claim presented in Chapter 1.2.3. To show that this claim is valid, three points have to be proven: that it investigates a *valid problem* (Le Dain et al., 2013), that the presented method *in itself works* (Barlas and Carpenter, 1990) and that it is *useful* (Pedersen et al., 2000).

5.2.1 Validity of research questions

Following Le Dain et al. (2013), to validate research, one needs to answer the question: “Are you doing the right research?”. This question has been answered as follows for both the contribution to academic knowledge, as well as to engineering design practice:

Validation of the research gap

In EDR function modelling methods have been researched for multiple purposes, with promising results for product representation, analysis, and exploration of novel concepts. Also, plenty of DSE methods based on CAD models and DA are available, from parameterised models (Krish, 2011) over MDA tool chains (Sandberg et al., 2017) to topologically flexible master models (La Rocca, 2012). So why is there a need for another DSE method?

Whereas function models lack a representation of the geometry which is necessary for engineering analysis, do CAD based approach lack the flexibility and DR representation which is needed to implement radically novel solutions. No modelling approach which directly connects product geometry—in the form of CAD models—to a function model for the purpose of DSE could be identified in the literature. The relevance of this gap is also highlighted by other researchers, such as

- Cohrs et al. (2014) calling for “interdisciplinary integration of function architectures with CAD models”,
- Tomiyama et al. (2013) highlighting the “missing direct connections with [...] geometric models” as a reason for function models being perceived as “not practical”,
- or Umeda and Tomiyama (1997) stating that “future CAD technology [...] should represent and reason about function”.

From these many-voiced statements it can be concluded that the EDR community sees a definite gap in the modelling landscape between the two domains of function and geometry, which this thesis has set out to close.

Validation of the industrial problem

While the research gap could be validated through a review of the EDR literature, the need in the industry had to be explored through empirical studies.

The research claim of this thesis calls for a DSE method for the conceptual phase of the development of complex engineering products, such as aeroengine components. Practitioners were observed in their daily practice through the action research approach pursued in several studies underlying this thesis. This information base was deepened through interviews and workshops, where current practices, needs, and challenges for the applied PDP were investigated. Paper A presents these kinds of observations in a DSE project, supported in Isaksson et al. (2016) (Paper [i]). These observations continue in Paper D, where the challenge in the industry-backed project was to investigate novel solutions and technologies. Paper F explores these observations through interviews and workshops, with practitioners directly confirming the needs for a method such which represents a product's function and geometry.

5.2.2 Verification of the method

Paper C presents a model for a DSE method, but it remained to be shown that the method actually *works*. Each of the three steps of the FGE method has been verified, with one study verifying the approach as a whole.

The *decomposition* of a legacy design into EF-M has already been documented by Landahl and Johannesson (2018); Levandowski et al. (2014); Raja and Isaksson (2015), and can therefore be presumed as proven. This is discussed in detail in Paper B. The research presented in this thesis adds onto EF-M a more refined description of the design space by distinguishing between constraint objects, as presented in Paper D. The same publication, together with Paper C, illustrates the decomposition stage of the approach in detail, and therefore verifies the initial step of FGE.

The *innovation* stage of the approach is also based on EF-M modelling, which has been effective in capturing and representing novel solutions and functions into an existing product architecture, presented in Paper A, Paper D, and Paper F. Practitioners stated that the method supports innovation, in both Paper D and Paper F. However, as per the feedback from practitioners presented in Paper F, there is room for improvement.

The *combination of functional and geometric modelling* has been a focus of all publications, but is most prominently explained in Paper C, Paper D and Paper E. The possibility of decomposing the *entire geometry* into a function model, the ability to capture novel solutions and link them into the existing product structure and the ability to map parameters across both domains verify the link between the function and geometry mod-

elling domain (Cohrs et al., 2014).

The *embodiment stage* has been shown to be functional in the DA implementation in OMFG and the accompanying omfgDSE tool. Paper E presents the DA approach for a TRS based on an industrial case study. While it has not been verified that the approach can scale to handle more complex products, it has been shown to work on a highly integrated aircraft engine component.

Paper E also shows all three stages of FGE applied on a single product, and thereby verifies the integration of the three stages of FGE into a holistic DSE approach.

Verification of tool

A proof-of-concept tool was developed to verify the FGE method. This tool supports the method through a user interface, data management, and an implementation of the DA algorithm. While the first two steps of the method can theoretically be—and have been, in Paper A and Paper D—performed without the tool, an implementation in the form of a digital tool is crucial for executing the embodiment stage, which relies on DA. Furthermore, the tool has been used in Paper F to support and guide the workflow of FGE and for interaction with practitioners.

One of the main functions of the tool is the mapping of geometry to function objects, that is a realisation of the *coupling of function and geometry models*. This has been achieved, as presented in Paper E. However, the level of DA and user experience (UX) are only developed to the degree necessary for an evaluation of the basic functionality. Although no official TRL assessment has been performed, the tool can be described as a “characteristic proof-of-concept”, which would correspond to TRL 3 (Mankins, 1995). While this level of maturation was sufficient for verification purposes, further development of the software is needed for real application of the method in a product development project.

5.2.3 Usefulness of the method

The research presented in this thesis addresses a relevant problem, see Paper A and Paper F. For this problem, a solution in the form of FGE has been presented in Paper C, and in Paper E it has been shown that the FGE approach theoretically works as proposed.

Practical usefulness was demonstrated in Paper D and Paper F, where the approach was applied in a practical context, supporting the development of an engineering product. New functions and solutions could be

mapped and explored and practitioners confirmed that this was due to the use of the FGE approach. While blended with constructive criticism, the practitioner feedback has declared the method as “one possibility to generate, and evaluate, lots of concepts”—which is what it aims for.

5.2.4 Method use

The presented research results were reached using different methods of data capture and evaluation, as presented in Chapter 3.4. This section assesses how well these methods were applied and how this affects the quality of the results.

The empirical data collection was performed at different aerospace companies. While there was a variation in the roles, skills, and experience of the participating engineers, the majority of interview partners and workshop participants are employed in the research and development departments of aerospace companies. This selection of participants can lead to a bias in the research results (Williamson and Bow, 2002). To counter this bias, the empirical data has always been evaluated together with more general results from the literature.

It is always difficult to generalise findings from action research, since the approach, with the researcher closely engaged in a specific environment, naturally sacrifices global relevance for local (Blessing and Chakrabarti, 2009). Therefore, although the approach appears to be solving a concrete problem in concept development in the aerospace industry, it is difficult to say whether it solves a general problem in engineering design. However, the research gap has been shown to be a relevant general problem in the EDR community. Furthermore, the approach has been tested in four different product development projects with three different companies (see Paper D and Paper F). While these are all in the same industry, this provides at least a certain level of “global relevance” for the aerospace sector.

That said, it cannot be conclusively determined that the reported usefulness in the case study in Paper F—the increased number of explored concepts—is linked to the application of the method. As mentioned in Chapter 3.2, the Hawthorne Effect can cause overly positive feedback which is only triggered by the *change* in method, not the *quality* of the new method (Rob MacCarney et al., 2007). The impact of such an effect can only be determined through further validation studies.

5.2.5 Reflections

In principle, the FGE method solves a valid and relevant problem: it enables the exploration of more, and more novel, alternative design concepts. It does so by proposing a modelling approach that closes the gap between two modelling domains, function and geometry.

However, both EDR and SE research have come up with DSE methods that explore the design space based on either function or geometry models. The question arises: why should FGE be applied—or continue to be developed—instead of other, potentially more mature, methods?

Among the most common methods—almost standard in today’s product development processes (Hirz et al., 2013)—is the mature technology *parametric CAD*. While it allows for a relatively effortless altering of a CAD model, the explorable design space is limited to dimensional variation. Although most CAD systems support the suppression and activation of features through parameters, thereby enabling a certain geometrical variability, such approaches are sensitive to larger changes in parameters, since the relations of their impacts are not mapped—potentially resulting in failed geometries (Kasik et al., 2005; Camba et al., 2021). Furthermore, the entire explorable design space needs to be coded into the parameterisation of the master model. As a result, parametric design requires designers to iterate between problem and solution space, incrementally expanding the parametric model once the search space of the parameterisation has been exhausted (Yu et al., 2014).

FGE, on the other hand, takes the dimensional bandwidth of parameterisation and includes it in the UDF, coupled to the DR in the EF-M model. As a result, each model can take on dimensional variability *on top of* the modular bandwidth. Furthermore, FGE supports the inclusion of entirely novel solutions on arbitrary levels of abstraction in the existing product model, where the introduction effort is reduced due to the interface mapping of OMFG.

The variety of CAD models that can be generated using DA approaches in KBE is much higher than for parametric CAD approaches. Furthermore, the level of automation is far more sophisticated than that presented for FGE. KBE approaches, such as presented by La Rocca (2012), are capable of managing, generating, and maintaining more complex geometries than FGE. However, the DA deficit in FGE can be attributed to the TRL of the presented approach. So far, the DA aspect has been realised in a *proof of concept*, demonstrating the general mechanics of the interface capture, assembly algorithm, and parameterisation. Further work towards

implementation is necessary.

The main difference between FGE and KBE is, however, the way how the geometry models are generated. Most KBE approaches exchange, alter or scale geometry based on topological and geometrical concerns. In the FGE approach, geometric changes are driven by a change in the product's function. By changing the DR—the reason for the design—the geometry is changed with it. In this modelling approach, *form does follow function*.

KBE focuses on the generation of variant CAD models, but even more so on the *knowledge* about their behaviour. Therefore, KBE approaches usually have a strong MDA aspect, where the routine tasks of analyses such as meshing and FEM are automated, and the results captured and presented for evaluation of the concepts, for example using parallel diagrams (Bertoni et al., 2018). The knowledge-based master models (KBMM) (Sandberg et al., 2017) are examples of this, which, similar to FGE, use the Siemens NX-based DA approach to generate CAD model variants. These models are then subjected to a MDA tool chain, coupling back into a feedback loop optimising the geometry. Where FGE only proposes the use of MDA, this approach realises it on an industry-applicable scale.

Approaches such as high-level CAD templates (HLCT) (Amadori et al., 2012) or functional features (Cheng and Ma, 2017) provide much more sophisticated DA approaches than FGE and also claim to take into account the product's function. However, neither employs an explicit function representation, thereby not providing support for “functional design” as is necessary according to Umeda and Tomiyama (1997). The same can be said for KBMM by Sandberg et al. (2017).

The idea for the use of MDA results in FGE differs in the way that the results can not only be presented, but directly put into context with the functions and constraints. This provides both a possibility for automated concept evaluation and a refinement of the design space based on the insights from the analysis process.

6

Conclusions

*Scientists discover the world that exists;
engineers create the world that never was.*

Theodore von Kármán

This thesis presents a design space exploration approach for the conceptual product development phase. The FGE approach enables the capture of novel functions and solutions, their representation in relation to a legacy design and automates the generation of the CAD models needed for their evaluation. To do so, the FGE relies on the OMFG, which provides a coupling of function and geometry models, and as such, shows how *form follows function*.

The approach is based the needs of product developers developing complex engineering products, such as in the aerospace industry. These needs have been established through empirical and literature studies. The approach prescribes a model to link two previously unconnected modelling domains in the product development process, function modelling and geometry modelling. The approach's contribution to applied product development has been shown in three studies in collaboration with industrial practitioners.

The research results, development and validation has been presented in six core publications (Paper A through F) which form this thesis, and the author's research has further contributed to 10 additional publications (Papers [i] through [x]).

6.1 Contribution and claim

The FGE approach enables DSE through a simultaneous, associated product representation in two different domains. Commonly applied approaches, such as parameterised CAD or function-means modelling, only represent an isolated product aspect, namely either function or geometry. By combining function modelling, to represent the design space and teleological product aspects, with geometric modelling, to represent and analyse, the approach supports design space representation, population, and concept analysis.

The result is a novel product development approach, which enables a function-oriented search for novel solutions and concepts. These novel concepts can be captured as functions and solutions in relation to an existing product structure. By using the OMFG, the representation of novel concepts can be automatically transferred from the functional to the geometrical domain. While admittedly more evolved DA approaches exist, they often operate on a closed-off design space, which is defined by geometrical considerations. The FGE approach drives the DA from a function-based perspective, where not only novel geometry, but novel functions and solutions are integrated into an existing legacy architecture. Furthermore does the design space of FGE remain open to novel solutions on all levels of product abstraction, and is not prematurely limited through the definition of a master model.

The approach has been validated in a laboratory environment, which would correspond TRL 4¹, and realised in a proof of concept tool. This approach, used together with the proof-of-concept tool, has proven to support developers in multiple studies in applied product development contexts.

From this, it can be concluded that FGE as a function- and geometry-based design space exploration approach *does* support the investigation into novel and radical design concepts in the conceptual product development phases.

6.2 Future work

The function-modelling approach EF-M chosen for FGE stands out for its representation of design space and DR and ease of introducing novel solutions on arbitrary abstraction levels. However, criticism has been voiced, especially in the study presented in Paper F, that certain relations between

¹No official TRL assessment has been performed. This approximate assessment has been done by the author based on reading Mankins (1995).

different functions and solutions are difficult and unintuitive to capture. Although EF-M is a well-established function-modelling approach, further research into the representation of highly integrated product architectures is needed.

Applying EF-M in the presented FGE, mostly FR and DS objects have been used to represent a product concept. While Paper D has also considered the modelling of C objects in EF-M, they have not played a major role in the further studies. Constraint modelling is, however, one of the major strengths of EF-M in both design space description as well as for concept evaluation. Further research into well-constrained EF-M models, especially in the focus of automated MDA or MDO approaches, is therefore considered necessary and valuable. Such developments would also enable the possible automated feedback of product information from the analysis stage into the EF-M model, which could allow for automated concept evaluation and comparison.

Through the connection between the function models and geometry models, FGE generates CAD models of each instantiated concept. While these models appear to be valid in Paper E, further development is needed to see whether they fulfil the criteria for automated meshing and subsequent analysis. The DA approach has furthermore not been assessed in terms of scalability and robustness. Several more mature DA approaches exist, hence further research into combining FGE with existing DA approaches may be of interest.

While CAD models are seen as the standard in product development, complex products such as aerospace components often employ models from other domains such as electrics, electronics, and programming. To enable a holistic design space exploration, covering the entire product life-cycle, a coupling between FGE and other relevant product models may be necessary. A further effect of this would be a more multidisciplinary product development approach.

So far, the validation of the approach has only been performed in an aerospace development context. Further studies are needed to establish generalisability of the FGE approach for other product development domains. Eventually, FGE aims to be a product development method which is capable to represent for all products how

form follows function.

References

- ACARE. Strategic Research and Innovation Agenda. Technical report, Advisory Council for Aviation Research and Innovation in Europe, 2017.
- A. Albers and S. Matthiesen. An Innovative New Basic Model in Design Methodology for Analysis and Synthesis of Technical Systems. In *International Conference on Engineering Design ICED 03*, pages 1–10, 2003.
- A. Albers and E. Sadowski. The Contact and Channel Approach (C&C2-A): relating a system’s physical structure to its functionality. In A. Chakrabarti and L. T. M. Blessing, editors, *An Anthology of Theories and Models of Design*. Springer, London, 2014. ISBN 978-1-4471-6337-4. doi: 10.1007/978-1-4471-6338-1{_}.8.
- A. Albers, C. Mandel, S. Yan, and M. Behrendt. System of Systems Approach for the Description and Characterization of Validation Environments. In *DESIGN 2018 - 15th International Design Conference*, pages 2799–2810, Cavt, 2018.
- C. Alexander. The state of the art in design methods. *DMG Newsletter*, 5(3):3–7, 1971.
- L. Almfelt, F. Berglund, P. Nilsson, and J. Malmqvist. Requirements management in practice: Findings from an empirical study in the automotive industry. *Research in Engineering Design*, 17(3):113–134, 2006. doi: 10.1007/s00163-006-0023-5.
- K. Amadori, M. Tarkian, J. Ölvander, and P. Krus. Flexible and robust CAD models for design automation. *Advanced Engineering Informatics*, 26(2):180–195, 2012. doi: 10.1016/j.aei.2012.01.004.
- Y. Barlas and S. Carpenter. Philosophical roots of model validation: two paradigms. *System Dynamics Review*, 6(2):148–166, 1990.
- A. Bertoni, S. K. Dasari, S. I. Hallstedt, and P. Andersson. Model-based decision support for value and sustainability assessment: applying machine learning in aerospace product development. In *International Design Conference - Design 2018*, pages 2585–2596, 2018. doi: <https://doi.org/10.21278/idc.2018.0437>.

REFERENCES

- H. Birkhofer, H. Kloberdanz, B. Berger, and T. Sauer. Cleaning up Design Methods - Describing Methods Completely and Standardised. *Proceedings of DESIGN 2002, the 7th International Design Conference*, 30:17–22, 2002.
- L. T. M. Blessing and A. Chakrabarti. *DRM, a Design Research Methodology*. Springer, 2009. ISBN 9781848825864.
- B. Boehm. *Spiral Development: Experiences, Principles and Refinements*, 2000.
- O. Borgue, J. R. Müller, M. Panarotto, and O. Isaksson. Function modelling and constraints replacement for additive manufacturing in satellite component design. In *Proceedings of NordDesign 2018*, Linköping, Sweden, 2018.
- O. Borgue, J. R. Müller, A. Leicht, M. Panarotto, and O. Isaksson. Constraint replacement-based design for additive manufacturing of satellite components: Ensuring design manufacturability through tailored test artefacts. *MPDI Aerospace*, 6(11), 2019. doi: 10.3390/aerospace6110124.
- R. Bracewell, K. Shea, P. Langdon, L. T. M. Blessing, and P. J. Clarkson. A Methodology for Computational Design Tool Research. In *International Conference on Engineering Design ICED01*, Glasgow, 2001.
- R. Bracewell, K. Wallace, M. Moss, and D. Knott. Capturing design rationale. *CAD Computer Aided Design*, 41(3):173–186, 2009. doi: 10.1016/j.cad.2008.10.005.
- J. D. Camba, M. Contero, and P. Company. Parametric CAD modeling : An analysis of strategies for design reusability. *Computer-Aided Design*, 74:18–31, 2016. doi: 10.1016/j.cad.2016.01.003.
- J. D. Camba, M. Contero, P. Company, and N. Hartman. The cost of change in parametric modeling: A roadmap. *Computer-Aided Design and Applications*, 18(3):634–643, 2021. doi: 10.14733/cadaps.2021.634-643.
- Z. Cheng and Y. Ma. Explicit function-based design modelling methodology with features. *Journal of Engineering Design*, 28(3):205–231, 2017. doi: 10.1080/09544828.2017.1291920.
- M. Cohrs, S. Klimke, and G. Zachmann. Streamlining Function-oriented Development by Consistent Integration of Automotive Function Architectures with CAD Models. *Computer-Aided Design and Applications*, 11(4):399–410, 2014. doi: 10.1080/16864360.2014.881182.
- P. D. Collopy and J. Otero. Value-driven design. In *9th AIAA Aviation Technology, Integration and Operations Conference (ATIO)*, pages 450–463, Hilton Head, South Carolina, 2009. ISBN 9781622760305.
- N. Cross. *Developments in design methodology*. John Wiley & Sons, Inc., 1984.
- E. Dale, B. Jorns, and A. Gallimore. Future Directions for Electric Propulsion Research. *Aerospace*, 7(9):120, 2020. doi: 10.3390/aerospace7090120.

REFERENCES

- M. Darecki, C. Edelstenne, T. Enders, E. Fernandez, P. Hartman, J.-P. Herteman, M. Kerkloh, I. King, P. Ky, M. Mathieu, G. Orsi, G. Schotman, C. Smith, and J.-D. Wörner. Flightpath 2050. *Flightpath 2050 Europe's Vision for Aviation*, page 28, 2011. doi: 10.2777/50266.
- T. Devezas. Aeronautics and COVID-19: a Reciprocal Cause-and-Effect Phenomenon. *Journal of Aerospace Technology and Management*, 12(12), 8 2020. doi: 10.5028/jatm.v12.1183.
- J. R. Dixon. On research methodology towards a scientific theory of engineering design. *Artificial Intelligence for Engineering, Design, Analysis and Manufacturing*, 1(3):145–157, 1987. doi: 10.1017/S0890060400000251.
- C. M. Eckert, P. J. Clarkson, and M. K. Stacey. The Spiral of Applied Research: a Methodological View on Integrated Design Research. In *ICED03: 14th International Conference on Engineering Design*, Stockholm, Sweden, 2003.
- C. M. Eckert, P. J. Clarkson, and M. K. Stacey. The Lure of the Measurable in Design Research. In *International design conference - DESIGN 2004*, 2004.
- B. Eisenbart, L. T. M. Blessing, and K. Gericke. Functional Modellig Perspectives Across Disciplines: A Literature Review. *Proceedings of the 12th International Design Conference DESIGN 2012*, page 847–858, 2012.
- B. Eisenbart, K. Gericke, and L. T. M. Blessing. DSM for modeling and analyzing functionality: Views of practitioners. In *Modeling and Managing Complex Systems - Proceedings of the 17th International DSM Conference*, 2015. ISBN 9783446445734. doi: 10.3139/9783446447264.016.
- J. A. Estefan. Survey of Model-Based Systems Engineering (MBSE) Methodologies. Technical report, INCOSE MBSE Initiative, 2008.
- S. Friedenthal, R. Griego, and M. Sampson. INCOSE model based systems engineering (MBSE) initiative. Technical report, INCOSE, 2007.
- K. Gericke and B. Eisenbart. The integrated function modeling framework and its relation to function structures. *Artificial Intelligence for Engineering Design, Analysis and Manufacturing (AIEDAM)*, 31(4):436–457, 2017. doi: 10.1017/S089006041700049X.
- K. Gericke, C. M. Eckert, and M. Stacey. What do we need to say about a design method ? In *International Conference on Engineering Design ICED 17*, Vacouver, Canada, 2017.
- J. S. Gero and J. W. T. Kan. *Experimental Design Research*. Springer International Publishing, 2016. ISBN 978-3-319-33779-1. doi: 10.1007/978-3-319-33781-4.

REFERENCES

- J. S. Gero and U. Kannengiesser. The situated function-behaviour-structure framework. *Design Studies*Gero, J.S. and Kannengiesser, U. (2004), "The situated function-behaviour-structure framework", *Design Studies*, Vol. 25 No. 4, pp. 373–391., 25(4):373–391, 2004. doi: 10.1016/j.destud.2003.10.010.
- C. González-Lluch, P. Company, M. Contero, J. D. Camba, and R. Plumed. A survey on 3D CAD model quality assurance and testing tools. *CAD Computer Aided Design*, 83:64–79, 2017. doi: 10.1016/j.cad.2016.10.003.
- C. Haskins, J. Lee, and L. Miller. *INCOSE - Systems Engineering Handbook*. INCOSE, 2007.
- T. Heikkinen and J. R. Müller. *Assessment of Multidisciplinary Analysis Systems in Aerospace Product Development*. PhD thesis, Jönköping University, Jönköping, 2015.
- T. Heikkinen, J. Johansson, and F. Elgh. Review of CAD-model capabilities and restrictions for multidisciplinary use. *Computer-Aided Design and Applications*, 4360(January):1–11, 2018. doi: 10.1080/16864360.2017.1419639.
- T. Heikkinen, R. Stolt, and F. Elgh. Incorporating Design for Additive Manufacturing in Multidisciplinary Design Automation - Challenges Identified. *Proceedings of CAD'19*, pages 372–376, 2019. doi: 10.14733/cadconfp.2019.372-376.
- B. Helms and K. Shea. Computational Synthesis of Product Architectures Based on Object-Oriented Graph Grammars. *Journal of Mechanical Design*, 134(2): 021008, 2012. doi: 10.1115/1.4005592.
- R. M. Henderson and K. B. Clark. Architectural Innovation: The Reconfiguration of Existing Product Technologies and the Failure of Established Firms. *Administrative Science Quarterly*, 35(1):9, 1990. doi: 10.2307/2393549.
- J. Hirtz, R. B. Stone, D. A. McAdams, S. Szykman, and K. L. Wood. A functional basis for engineering design: Reconciling and evolving previous efforts. *Research in Engineering Design*, 13(2):65–82, 2002. doi: 10.1007/s00163-001-0008-3.
- M. Hirz, a. W. Dietrich, A. Gfrerrer, and J. Lang. *Integrated computer-aided design in automotive development: Development processes, geometric fundamentals, methods of CAD, knowledge-based engineering data management*. Springer, 2013. ISBN 9783642119408. doi: 10.1007/978-3-642-11940-8.
- C. M. Hoffmann. Constraint-Based Computer-Aided Design. *Journal of Computing and Information Science in Engineering*, 5(3):182, 2005. doi: 10.1115/1.1979508.
- A. Hopgood. *Intelligent Systems Engineers and Scientists*. CRC Press, 2nd edition, 2001. ISBN 0849304563.
- V. Hubka and W. E. Eder. *Theory of Technical Systems*. Springer Berlin Heidelberg, 1988. ISBN 978-3-642-52123-2. doi: 10.1007/978-3-642-52121-8.

REFERENCES

- IEEE. ISO/IEC/IEEE 24765 Systems and software engineering - Vocabulary. Technical report, International Standard, 2017.
- O. Isaksson. A generative modeling approach to engineering design. In *International Conference on Engineering Design ICED 03*, 2003.
- O. Isaksson. A Collaborative Engineering Design Research Model - An Aerospace Manufacturers View. In *Impact of Design Research on Industrial Practice*, pages 363–381. Springer International Publishing, Cham, 2016. doi: 10.1007/978-3-319-19449-3{_}24.
- O. Isaksson, M. Kossmann, M. Bertoni, H. Eres, A. Monceaux, A. Bertoni, S. Wiseall, and X. Zhang. Value-Driven Design - A methodology to Link Expectations to Technical Requirements in the Extended Enterprise. *INCOSE International Symposium*, 23(1):803–819, 2013. doi: 10.1002/j.2334-5837.2013.tb03055.x.
- O. Isaksson, A. Bertoni, C. E. Levandowski, J. R. Müller, D. Wiklund, P. Johansson, and H. Johannesson. Virtual contextual validation of technologies and methods for product development. In *Proceedings of International Design Conference, DESIGN*, volume DS 84, pages 669–678, 2016.
- O. Isaksson, C. Eckert, M. Panarotto, and J. Malmqvist. You Need To Focus To Validate. *Proceedings of the Design Society: DESIGN Conference*, 1:31–40, 2020. doi: 10.1017/dsd.2020.116.
- E. K. Jackson, D. Seifert, M. Dahlweid, T. Santen, N. Bjørner, and W. Schulte. Specifying and composing non-functional requirements in model-based development. *Lecture Notes in Computer Science (including subseries Lecture Notes in Artificial Intelligence and Lecture Notes in Bioinformatics)*, 5634 LNCS:72–89, 2009. doi: 10.1007/978-3-642-02655-3{_}7.
- L. S. Jensen, A. G. Özkil, and N. H. Mortensen. Prototypes in engineering design: Definitions and strategies. *Proceedings of International Design Conference, DESIGN*, DS 84:821–830, 2016.
- Y. Jin and W. Li. Design Concept Generation: A Hierarchical Coevolutionary Approach. *Journal of Mechanical Design*, 129(10):1012, 2007. doi: 10.1115/1.2757190.
- H. Johannesson, J. Landahl, C. E. Levandowski, and D. Raudberget. Development of product platforms: Theory and methodology. *Concurrent Engineering: Research and Applications*, 25(3):195–211, 2017. doi: 10.1177/1063293X17709866.
- J. A. Jupp. The design of future passenger aircraft - the environmental and fuel price challenges. *Aeronautical Journal*, 120(1223):37–60, 2016. doi: 10.1017/aer.2015.4.

REFERENCES

- E. Kang, E. K. Jackson, and W. Schulte. An Approach for Effective Design Space Exploration. *Foundations of Computer Software. Modeling, Development, and Verification of Adaptive Systems: 16th Monterey Workshop 2010, Redmond, WA, USA, March 31- April 2, 2010, Revised Selected Papers*, pages 33–54, 2011. doi: 10.1007/978-3-642-21292-5{_}3.
- D. J. Kasik, W. Buxton, and D. R. Ferguson. Ten cad challenges. *IEEE Computer Graphics and Applications*, 25(2):81–92, 2005. doi: 10.1109/MCG.2005.48.
- S. Krish. A practical generative design method. *CAD Computer Aided Design*, 43(1):88–100, 2011. doi: 10.1016/j.cad.2010.09.009.
- T. S. Kuhn. *The structure of scientific revolutions*, 1970.
- B. M. Kulfan. Universal parametric geometry representation method. *Journal of Aircraft*, 45(1):142–158, 2008. doi: 10.2514/1.29958.
- G. La Rocca. Knowledge based engineering: Between AI and CAD. Review of a language based technology to support engineering design. *Advanced engineering informatics*, 26(2):159–179, 2012. doi: 10.1016/j.aei.2012.02.002.
- J. Landahl and H. Johannesson. Product Variety and Variety in Production. In *International Design Conference - Design 2018*, pages 817–828, Cavtat, Croatia, 2018.
- L. Larsson, T. Grönstedt, and K. G. Kyprianidis. Conceptual design and mission analysis for a geared turbofan and an open rotor configuration. *Proceedings of the ASME Turbo Expo*, 1:359–370, 2011. doi: 10.1115/GT2011-46451.
- B. Lawson and D. Samson. Developing Innovation Capability in Organisations: a Dynamic Capabilities Approach. *International Journal of Innovation Management*, 05(03):377–400, 2001. doi: 10.1142/S1363919601000427.
- M. A. Le Dain, E. Blanco, and J. D. Summers. Assessing design research quality: Investigating verification and validation criteria. *Proceedings of the International Conference on Engineering Design, ICED*, 2 DS75-02(August):183–192, 2013.
- C. E. Levandowski, D. Raudberget, and H. Johannesson. Set-Based Concurrent Engineering for early phases in platform development. In *Proceedings of the 21st ISPE Inc. International Conference on Concurrent Engineering, CE 2014*, pages 564–576, Beijing, China, 2014. ISBN 9781614994398. doi: 10.3233/978-1-61499-440-4-564.
- H. Li, T. Brockmöller, P. C. Gembariski, and R. Lachmayer. An Investigation of a Generative Parametric Design Approach for a Robust Solution Development. *Proceedings of the Design Society: DESIGN Conference*, 1(May):315–324, 2020a. doi: 10.1017/dsd.2020.273.

REFERENCES

- T. Li, H. Lockett, and C. Lawson. Using requirement-functional-logical-physical models to support early assembly process planning for complex aircraft systems integration. *Journal of Manufacturing Systems*, 54(December 2018):242–257, 2020b. doi: 10.1016/j.jmsy.2020.01.001.
- M. Lind. Modeling Goals and Functions of Complex Industrial Plants. *Applied Artificial Intelligence an International Journal*, 8(2):259–283, 1994. doi: 10.1080/08839519408945442.
- U. Lindemann. *Methodische Entwicklung technischer Produkte*. Springer, Berlin, 2007.
- J. Malmqvist. Improved function-means trees by inclusion of design history information. *Journal of Engineering Design*, 8(2):107–117, 1997. doi: 10.1080/09544829708907955.
- J. C. Mankins. Technology Readiness Levels. *White Paper April*, 6:5, 1995. doi: 10.1080/08956308.2010.11657640.
- D. N. Mavris, D. A. DeLaurentis, O. Bandte, and M. A. Hale. A Stochastic Approach to Multi-disciplinary Aircraft Analysis and Design. *AIAA 36th Aerospace Sciences Meeting & Exhibit*, 1998. doi: 10.2514/6.1998-912.
- H. Mokhtarian, E. Coatanéa, and H. Paris. Function modeling combined with physics-based reasoning for assessing design options and supporting innovative ideation. *Artificial Intelligence for Engineering Design, Analysis and Manufacturing (AIEDAM)*, 31(4), 2017. doi: 10.1017/S0890060417000403.
- M. D. Moore. Misconceptions of Electric Aircraft and their Emerging Aviation Markets. *52nd Aerospace Sciences Meeting*, pages 1–17, 2014. doi: 10.2514/6.2014-0535.
- P. Nilsson and B. Fagerström. Managing stakeholder requirements in a product modelling system. *Computers in Industry*, 57(2):167–177, 2006. doi: 10.1016/j.compind.2005.06.003.
- D. Omidvarkarjan, D. Cipriano, R. Rosenbauer, M. Biedermann, and M. Meboldt. Implementation of a design support tool for additive manufacturing using a feature database: an industrial case study. *Progress in Additive Manufacturing*, 5(1):67–73, 2020. doi: 10.1007/s40964-020-00119-5.
- J. S. Osmundson, T. V. Huynh, and P. Shaw. Developing Ontologies for Interoperability of Systems of Systems . In *Conference of Systems Engineering Research*, 2006.
- G. Pahl, W. Beitz, J. Feldhusen, and K.-H. Grote. *Konstruktionslehre: Grundlagen erfolgreicher Produktentwicklung. Methoden und Anwendung*. Springer-Verlag, 2003. ISBN 3540003193. doi: 10.1007/978-1-84628-319-2.

REFERENCES

- M. Panarotto, O. Isaksson, and L. Asp. Assessing the value of radical technology alternatives at system level. In *DESIGN 2018 - 15th International Design Conference*, pages 633–642, Cavtat, Croatia, 2018.
- A. Papageorgiou, J. Ölvander, K. Amadori, and C. Jouannet. Multidisciplinary and multifidelity framework for evaluating system-of-systems capabilities of unmanned aircraft. *Journal of Aircraft*, 57(2):317–332, 2020. doi: 10.2514/1.C035640.
- K. Pedersen, R. Bailey, J. K. Allen, and F. Mistree. Validating Design Methods & Research: the Validation Square. In *ASME Design Engineering Technical Conferences*, pages 1–12, Baltimore, Maryland, USA, 2000. doi: DETC2000/DTM-14579.
- K. Popper. *The Logic of Scientific Discovery*. Routledges Classics, London and New York, 2002. ISBN 0-203-99462-0.
- B. Prasad. *Best Practices in KBE*. COE/DPC-KBE Task Force, 2006.
- V. Raja and O. Isaksson. Generic Functional Decomposition of an Integrated Jet Engine Mechanical Sub System Using a Configurable Component Approach. In *Proceedings of the 22nd ISPE Inc. International Conference on Concurrent Engineering*, pages 337–346, Delft, Netherlands, 2015. doi: 10.3233/978-1-61499-544-9-337.
- V. Raja, M. Kokkolaras, and O. Isaksson. A simulation-assisted complexity metric for design optimization of integrated architecture aero-engine structures. *Structural and Multidisciplinary Optimization*, 2019.
- Y. Reich. The study of design research methodology. *Journal of Mechanical Design, Transactions of the ASME*, 117(2A):211–214, 1995. doi: 10.1115/1.2826124.
- Rob MacCarney, James Warner, Steve Iliffe, Robbert van Haselen, Mark Griffin, and Peter Fisher. The Hawthorne Effect: a randomised, controlled trial. *BMC Medical Research Metthodology*, 7(30):1–8, 2007.
- N. F. M. Roozenburg and J. Eekels. *Product Design: Fundamentals and Methods.*, volume 2. Wiley Chichester, 1995.
- M. Sandberg, I. Tyapin, M. Kokkolaras, O. Isaksson, J. O. Aidanpää, and T. Larsson. A Knowledge-based master-model approach with application to rotating machinery design. *Concurrent Engineering: Research and Applications*, 19(4): 295–305, 2011. doi: 10.1177/1063293X11424511.
- M. Sandberg, I. Tyapin, M. Kokkolaras, A. Lundbladh, and O. Isaksson. A knowledge-based master model approach exemplified with jet engine structural design. *Computers in Industry*, 85:31–38, 2017. doi: 10.1016/j.compind.2016.12.003.

REFERENCES

- T. Saxena and G. Karsai. Towards a generic design space exploration framework. In *Proceedings - 10th IEEE International Conference on Computer and Information Technology, CIT-2010*, pages 1940–1947, Bradford, UK, 2010. ISBN 9780769541082. doi: 10.1109/CIT.2010.330.
- P. Schachinger and H. Johannesson. Computer modelling of design specifications. *Journal of engineering design*, 11(4):317–329, 2000. doi: 10.1080/0954482001000935.
- J. Schmidt and M. Gelle. Commercial Aerospace Insight Report 2020, 2020.
- U. Sellgren. *Simulation driven design - A functional view of the design process*. PhD thesis, The Royal Institute of Technology, 1995.
- K. Shea, R. Aish, and M. Gourtovaia. Towards integrated performance-driven generative design tools. *Automation in Construction*, 14(2 SPEC. ISS.):253–264, 2005. doi: 10.1016/j.autcon.2004.07.002.
- H. A. Simon. *The sciences of the artificial*. MIT Press, 1996. ISBN 9780262691918. doi: 10.1016/S0898-1221(97)82941-0.
- K. Sinha, H. Omer, and O. L. De Weck. Structural complexity: Quantification, validation and its systemic implications for engineered complex systems. *Proceedings of the International Conference on Engineering Design, ICED*, 4 DS75-04 (August):189–198, 2013.
- D. K. Sobek, A. C. Ward, and J. K. Liker. Toyota’s principles of set-based concurrent engineering. *MIT Sloan Management Review*, 40(2):67–83, 1999. doi: 3432.
- M. Stokes. *Managing engineering knowledge—MOKA: methodology for knowledge based engineering applications*. Professional Engineering Publ, London, 2001. ISBN 1860582958;9781860582950;.
- N. P. Suh. *The principles of design*. Oxford University Press New York, 1990. ISBN 0195043456.
- J. D. Summers, C. M. Eckert, and A. Goel. Function in engineering: Benchmarking representations and models. *Proceedings of the International Conference on Engineering Design, ICED*, 2 DS75-02(August):223–232, 2013. doi: 10.1017/S0890060417000476.
- Y. Suzuki, Y. Jin, H. Koyama, and G. Kang. An Application of Simulation Based Process Design. In *New World Situation: New Directions in Concurrent Engineering*. 2010. ISBN 978-0-85729-023-6. doi: 10.1007/978-0-85729-024-3.
- T. Tomiyama, T. J. Van Beek, A. A. A. Cabrera, H. Komoto, and V. D’Amelio. Making function modeling practically usable. *Artificial Intelligence for Engineering Design, Analysis and Manufacturing (AIEDAM)*, 27(3):301–309, 2013. doi: 10.1017/S0890060413000309.

REFERENCES

- D. G. Ullman. *The Mechanical Design Process*. McGraw-Hill, 2003. ISBN 0-07-237338-5.
- K. T. Ulrich and S. D. Eppinger. *Product Design and Development*. Boston, MA: McGraw-Hill/Irwin, pages 0–27, 2012. doi: 10.1016/B978-0-7506-8985-4.00002-4.
- Umair Irfan. Flying shame: Greta Thunberg gave up flights to fight climate change. Should you? - Vox, 11 2019.
- Y. Umeda and T. Tomiyama. Functional reasoning in design. *IEEE Expert-Intelligent Systems and their Applications*, 12(2):42–48, 1997. doi: 10.1109/64.585103.
- W. J. C. Verhagen, P. Bermell-Garcia, R. E. C. van Dijk, and R. Curran. A critical review of Knowledge-Based Engineering: An identification of research challenges. *Advanced Engineering Informatics*, 26(1):5–15, 2012.
- P. E. Vermaas and C. M. Eckert. My functional description is better! *Artificial Intelligence for Engineering Design, Analysis and Manufacturing (AIEDAM)*, 27(3): 187–190, 2013. doi: 10.1017/S089006041300019X.
- H. B. Voelcker and A. G. Requicha. Geometrical Modelling of Mechanical Parts and Processes. *Computer*, 1977.
- K. Williamson and A. Bow. *Research methods for students, academics and professionals: information management and systems*. Charles Sturt University. Centre for Information Studies, 2002. ISBN 1 876938 42 0.
- R. F. Woodbury and A. L. Burrow. Whither design space? *Artificial Intelligence for Engineering Design, Analysis and Manufacturing (AIEDAM)*, 20:63–82, 2006. doi: 10.1017/S0890060406060057.
- R. K. Yin. Case Study Reserach - Design and Methods. *Clinical Research*, 2:8–13, 2006. doi: 10.1016/j.jada.2010.09.005.
- R. Yu, N. Gu, M. Ostwald, and J. S. Gero. Empirical support for problem-solution coevolution in a parametric design environment. *Artificial Intelligence for Engineering Design, Analysis and Manufacturing (AIEDAM)*, 29(1):33–44, 2014. doi: 10.1017/S0890060414000316.