



Multi-Scale Validation of a Rib Fracture Prediction Method for Human Body Models

Downloaded from: <https://research.chalmers.se>, 2026-04-05 21:16 UTC

Citation for the original published paper (version of record):

Pipkorn, B., Iraeus, J., Björklund, M. et al (2019). Multi-Scale Validation of a Rib Fracture Prediction Method for Human Body Models. Conference proceedings International Research Council on the Biomechanics of Injury, IRCOBI, 2019: 175-192

N.B. When citing this work, cite the original published paper.

Multi-Scale Validation of a Rib Fracture Prediction Method for Human Body Models

Bengt Pipkorn, Johan Iraeus, Magnus Björklund, Olle Bunketorp and Lotta Jakobsson

Abstract A multi-scale validation of the capability of the SAFER human body model (v9) to predict the risk for an occupant to sustain two or more rib fractures in vehicle crashes was carried out. The rib fracture risk was evaluated by means of a probabilistic rib fracture prediction method. A variety of loading conditions was evaluated, from published lab tests with post mortem human subjects (PMHS) to detailed accident reconstructions and population-based reconstructions. The PMHS load cases were table-top, impactor and sled tests. The detailed accident reconstructions included 20 occupants involved in real-world crashes. For the population-based reconstructions more than 100 simulations with a generic vehicle interior model were carried out. Parameters regarding both the generic model and the occupant were varied in the population-based simulations. The predicted risk for an occupant to sustain two or more rib fractures was evaluated for the PMHS sled reconstructions as well as for the detailed and population-based reconstructions. The predicted 2 or more rib fracture risk was compared to the actual number of fractured ribs sustained by the PMHS and the occupants. Generally, two or more fractured ribs observed in the PMHS tests, the vehicle crashes and NASS data were successfully predicted with the model

Keywords Human Body Model, Reconstructions, Rib Fracture Prediction, THUMS, Validation

I. INTRODUCTION

Occupant protection systems, such as seat belts and airbags, are developed and evaluated by means of crash tests with anthropometric test devices (ATDs) serving as human occupant substitutes. These ATDs were developed to measure global injury criteria such as, for example, chest deflection. The global criteria are attributed to chest injury risk of a certain AIS value by an injury risk curve (IRC). The ATDs are developed to predict human kinematics and injury risk for a specific crash direction, such as frontal for the HIII and THOR ATDs or side impact for the WorldSID and SIDII. The biofidelity and ability of an ATD to predict injury risk for other crash directions than the one it was designed for is limited. Chest deflection is measured in one point in the HIII ATD and in four points in the THOR ATD. This means that there can be significant local deformations of the chest that are not recorded by the transducers. For the development of future advanced restraint systems there is, therefore, a need to address local chest injuries, such as isolated rib fractures, omnidirectionally in addition to globally for the whole chest of the occupant.

In recent years, mathematical human body models (HBMs), including finite element (FE) HBMs, have been developed to complement mechanical ATDs as an evaluation and development tool for occupant protection assessments. The HBM has several advantages in these tasks compared to the ATD. The HBM is omnidirectional by design and can therefore predict human kinematics and injury risk for all crash directions, including those that are in-between the pure frontal and side collisions, usually referred as oblique crashes. The FE-HBMs have a detailed representation of the human anatomy and material properties. In the HBM the injury risk can be evaluated for specific anatomical structures, which makes it possible to address injury at a detailed level, such as at a tissue level. These models enable evaluation of physical variables mechanically related to injury, e.g. energy and strain [1]. Trosseille *et al.* [2] suggest that rib fractures are strain controlled.

B. Pipkorn (e-mail: bengt.pipkorn@autoliv.com; tel: +46 (0)322 626341) is Adjunct Professor at Chalmers University of Technology, Gothenburg, and Director of Simulation and Active Structures at Autoliv Research, Vårgårda, Sweden. J. Iraeus is a researcher at Chalmers University of Technology. M. Björklund is Attribute Leader at Volvo Cars Safety Centre, Gothenburg. O. Bunketorp is Associate Professor at Department of Orthopaedics, Institute of Clinical Sciences, Sahlgrenska Academy, University of Gothenburg. L. Jakobsson is Senior Technical Leader of Injury Prevention at Volvo Cars Safety Centre and Adjunct Professor in Vehicle Safety at Chalmers. All authors are associated with SAFER – Vehicle and Traffic Safety Center at Chalmers in Sweden.

A strain-based probabilistic method to predict rib fracture risk with whole-body FE models was proposed by Forman *et al.* [3]. The probability for local rib fractures in each rib was estimated based on an age-adjusted ultimate strain distribution. This ultimate strain distribution was developed from a literature dataset of 133 material tests. In a second step, the probabilities for each rib were combined to predict the whole ribcage injury risk at a predefined severity level. The proposed method predicts rib fracture risk regardless of loading direction and whether the deformation is global or local.

Today, there are several HBMs representing average-sized male occupants, of which the two most popular HBMs are the Total Human Model for Safety (THUMS) AM50 [4] and the Global Human Body Model Consortium (GHBMC) M50-O [5]. However, in studies with both of these HBMs it was shown that chest injury risk was overpredicted compared to real-world accident data [6-7]. In other studies, it was shown that the models underpredicted the number of fractured ribs compared to Post Mortem Human Subjects (PMHS) [8-10]. It was suggested that the injury risk prediction could be improved with increased anatomical detail and improved biofidelity of material models, and that it would require validation to tissue-level measurements, such as stress and strain. Another HBM, the SAFER HBM version 9, was validated for force, deflection and strain predictions [11]. The next step will be to validate the model for rib fracture prediction.

The capability of a HBM to predict rib fracture risk can be evaluated by various methods. A frequently used method is to model PMHS tests in detail and compare the predicted injury risk with the outcome of the PMHS tests. PMHS tests with loading and boundary conditions of different complexity can be used, such as component level table-top [12] and full-body sled tests [13]. Another method is to reconstruct a few real-life crashes at a high level of detail and compare the predicted injury risk with the actual injury outcome. A third method is to use stochastic population-based reconstructions in which real-life crashes are reconstructed based on statistics [14]. Injury risk predictability can be evaluated by comparing risk curves constructed for both the real-life crashes and the stochastic reconstructions.

The aim of the study is to validate the capability of the SAFER HBM version 9 to predict the risk for an occupant to sustain two or more fractured ribs (NFR 2+) for a variety of loading conditions. Such a validation provides a broad foundation and confidence in the capability of the model. An extended aim is to evaluate the influence on rib fracture risk by varying the body size of the vehicle occupant.

II. METHODS

For the validation, a variety of data sources were used. The loading conditions were based on published table-top and sled tests with PMHS, detailed accident reconstructions with data from Volvo Cars internal database and population-based reconstructions based on NASS data. One table-top PMHS test, three sled test series, 20 detailed reconstructions and two population-based reconstructions, one frontal and one side, were carried out. The validation was carried out with the SAFER HBM v.9, which is a modified THUMS v3 representing a 50th percentile male [15]. Modifications included remodeling of the ribcage and lumbar and cervical spine (modifications detailed in Appendix A) [15].

PMHS Table-top Tests

For the validation on component level, a published table-top load case was selected in which five denuded PMHS thoraxes were loaded by means of rigid indentors covered by rubber [16]. The indenter speed was 1 m/s and the strokes were either 18–30 mm (non-injurious) or 80 mm (injurious). The mid-thorax impact location was chosen for the validation in this study. The setup for the two injurious mid-sternum tests and the corresponding simulation model can be observed in Fig. 1. During the injurious tests, at least two fractured ribs were received by both test subjects. The two tests showed completely different impactor to ribcage interactions: the impactor in test 4.8 stayed at the initial position, while it slid along sternum in test 5.8. Initial simulations showed that the

response was sensitive to the friction between the impactor and the ribcage. To quantify this uncertainty, three simulations were carried out with friction coefficients (static and dynamic) set to 0.05, 0.3 and 0.6. The 0.05 and 0.6 levels represent two extreme cases, low and high friction, while the 0.3 is an in-between level often used in crash simulations when the friction is unknown. The average age at death for the two PMHS used for this study was 60 years. Details about predicted and measured kinetics, kinematics and rib strains can be found in Iraeus and Pipkorn [15].



Fig. 1. Denuded thorax indenter impacts at mid-sternum (centre located at Rib 5). *Left*: pre-test 4.8 (adopted from Shaw *et al.*, 2007) [17]; *middle*: pre-test 5.8 (adopted from Shaw *et al.*, 2007) [17]; *right*: simulation model setup.

PMHS Sled Tests

For the validation by means of sled PMHS tests, three different published series were used for the evaluation (Fig. 2). The first series was tests carried out using a Ford Taurus MY1999 buck [18]. In this series three subjects were tested. The sled delta velocity (DV) was 30 km/h and the subjects were restrained with a three-point belt system without load limiter and pretensioner. No fractured ribs were sustained by any of the PMHS. The second series was carried out in a generic environment comprising a horizontal steel sheet as seat and the knees constrained by a rigid fixation [19]. This configuration is commonly referred to as Gold Standard. In this series, eight PMHS, belted with three-point belt system without pretensioner and load limiter, were tested. All PMHS sustained two or more fractured ribs. In the third test series two subjects were tested in a modified version of the Gold Standard environment [20]. The sled DV was 30 km/h and the PMHS were restrained with a load limited three-point belt system. The belt was limited to 2.9 kN at the shoulder. No fractures were sustained by any of the PMHS. Details about predicted and measured kinetics, kinematics and rib strains can be found in Iraeus and Pipkorn [15].

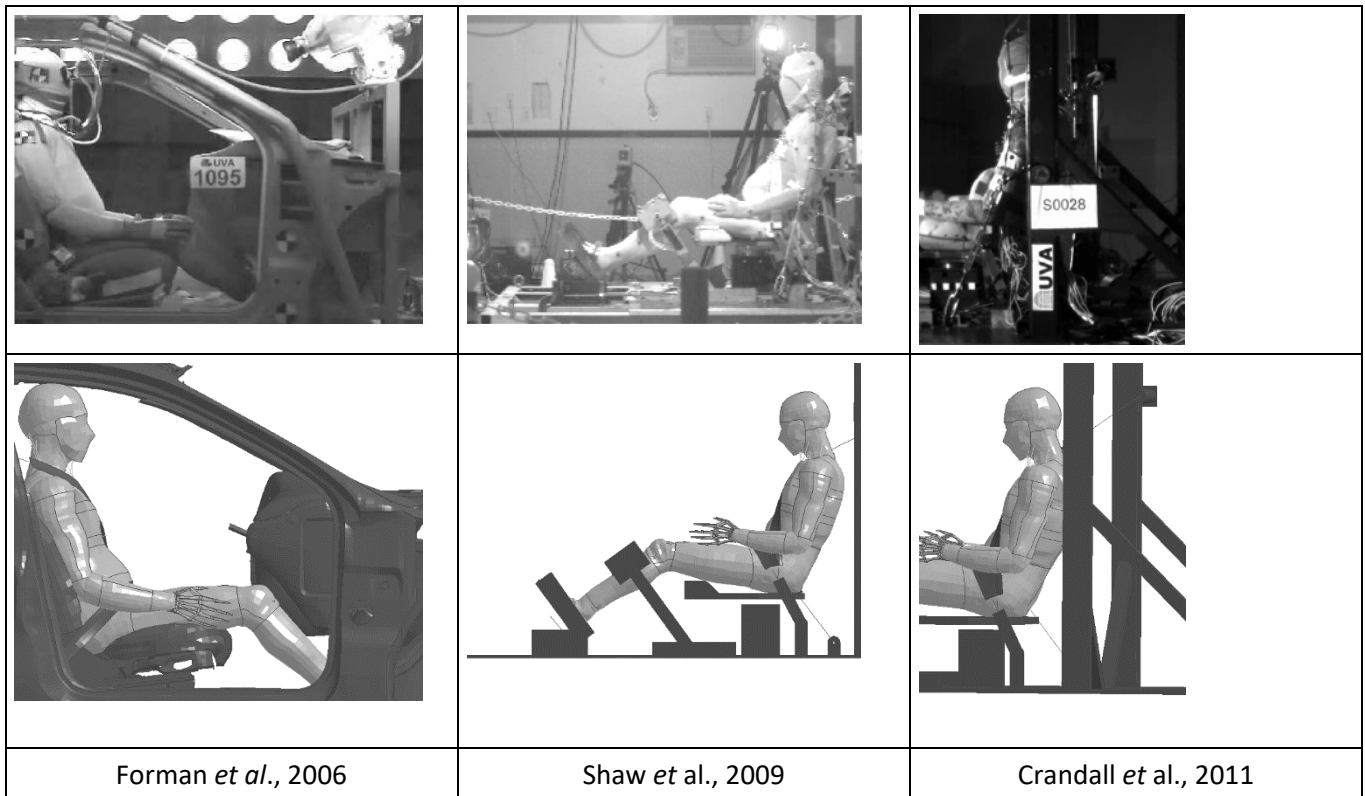

Fig. 2. Published sled test series used for validation.

Detailed Accident Reconstructions

For the validation by means of detailed reconstructions, occupants were selected from the Volvo Cars Traffic Accident Databases (statistical and in-depth), which contain details of crashes involving Volvo cars in Sweden [21]. Targeting mainly injured occupants, the selection criteria were crashes where in-depth information was available, including crash pulse information. Another selection criterion was that there were validated detailed FE interior models available for the vehicle, enabling detailed reconstructions. Some of the cases were extracted from the statistical database where the information is based mainly on questionnaires, in addition to detailed medical information, photos of the cars and police reports. In most of the injury cases, when relevant, radiology was gathered and analysed. Some of the cases were extracted from the in-depth database, in which the vehicles undergo an in-depth analysis that includes on-site investigations, thorough vehicle analysis in the workshop and interviews with those involved, in addition to the detailed medical information and the material available in the statistical dataset.

The cases include drivers and passengers of a variety of sizes and ages, in a variety of crash severities (see details in Appendix B). In total, 20 cases were reconstructed. One of the occupants was exposed to a side impact, while the others were exposed to different types of frontal impact with varying overlap, direction and severity. The crashes occurred between 2009 and 2017 and involved Volvo cars of model years 2003–2016. Eleven of the 20 occupants sustained an injury (2 MAIS1, 4 MAIS2, 5 MAIS3 and 1 MAIS 4), of which 10 sustained chest injuries. Four occupants sustained rib fractures, two of them with pneumothorax. Three of the occupants sustained sternum fractures, two of the occupants chest contusion, one occupant lung contusion, one occupant a bleeding lung and one occupant a spleen rupture.

Each reconstruction was run using a validated FE model of the specific vehicle, and with the crash pulse measured at the real-world crash. In two of the cases, three-axis acceleration data were available, in 10 cases longitudinal (x) and lateral (y) accelerations were available and in three cases only longitudinal acceleration was available. In one of the cases (case number 5) the accelerations data were based on a reconstruction. Pretensioners and load limiters were present in all vehicles. The pretensioners were activated in all crashes and the activation times used in the modes were obtained from the crash recorders. Figure 3 shows examples of one

driver and one front passenger interior model. All simulations were run with the SAFER HBM v. 9, and the seat adjusted to the middle of the seat adjustment range.

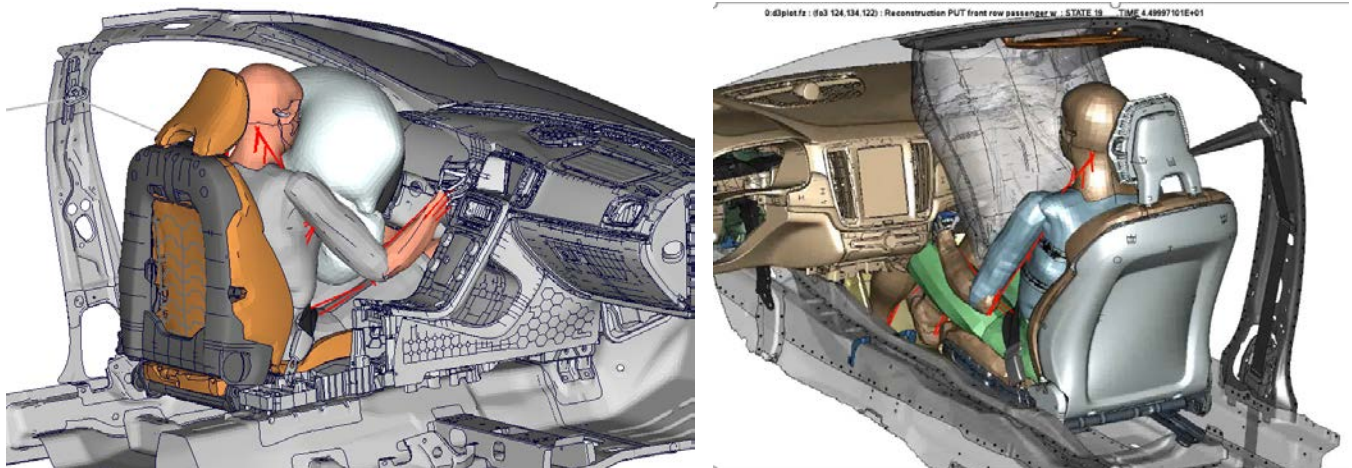

Fig. 3. Driver-side and passenger-side models for reconstructions.

Population-based Reconstructions

The population-based simulations were carried out using the same methodology as in Iraeus and Lindquist [14], with the addition that lateral impacts were also analysed. Two datasets were extracted from the NASS/CDS database containing cases with both injured and uninjured occupants, one for frontal impacts and one for lateral impacts. Inclusion criteria were: frontal impacts (GAD1="F") or side impact (GAD1="L" or "R"); model year later than 1999 (MY>1999); belted front-seat occupants at least 16 years old impacted at the near side and with an deployed airbag. Rollovers were excluded (ROLLOVER>0). This resulted in a set of n=5,083 cases (1,474,869 cases weighted), with 185 occupants (17,810 occupants weighted) having rib fractures (AIS2+) for the frontal analysis, and n=569 cases (166,209 cases weighted) with 60 occupants (3,495 occupants weighted) having rib fractures (AIS2+) for the lateral analysis. For these two sets weighted logistic regression was carried out in R version 3.2.3 [22] with R package 'survey' [23]. Occupant age and vehicle DV was used as regression co-variates.

One frontal and one lateral stochastic simulation study was defined. The SAFER HBM v. 9 was positioned in a generic parameterised FE model of a vehicle interior developed based on laser scans of 14 common passenger vehicles [14]. This model was further updated with parts important in near-side lateral impacts, specifically a seatback, a side airbag (SAB) and a simplified inflatable curtain (IC). The geometry of the seatback was created as an average of the same 14 vehicles as the rest of the model. Side structure intrusion was prescribed on coarse grid and then interpolated to the finer side structure mesh (Fig. 4). Parameters regarding both the generic car model, the crash pulse and the occupant were varied in the simulations in the same way as the variations occurred in the NASS dataset. Latin Hypercube sampling was used to generate 1,000 models for the frontal simulation and 100 models for the lateral simulation.

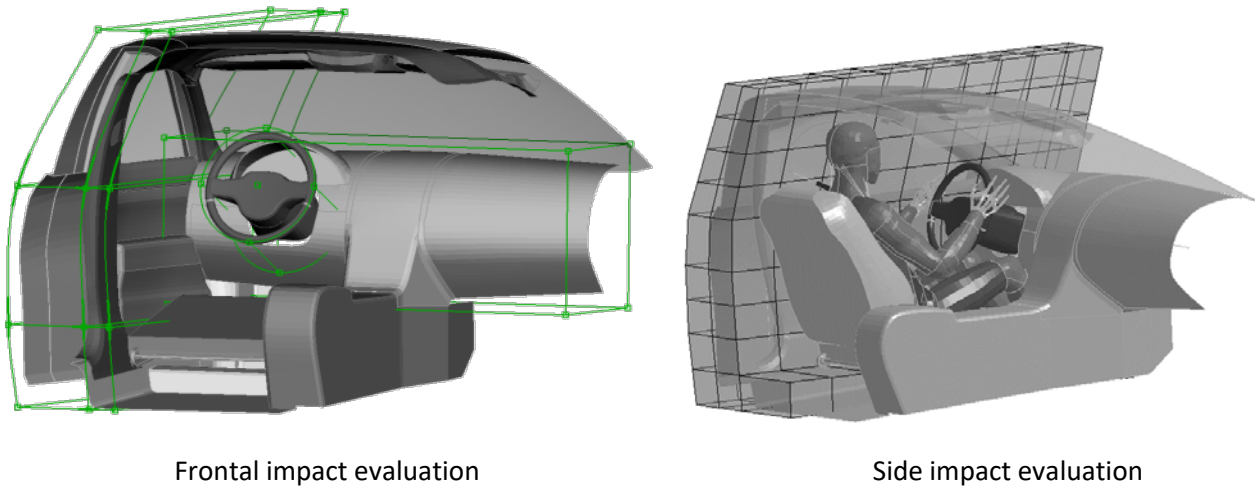

Fig. 4. Generic vehicle buck model used for the population-based frontal and side-impact study. The coarse grid covering the side structure is used to interpolate the side intrusion velocity profile onto the fine side structure mesh.

The probabilistic rib fracture prediction method proposed by Forman *et al.* [3] was used to assess the rib fracture risk at the AIS2+ level for the HBM in each of the stochastic simulations. Next, logistic regression was used to create risk curves based on the frontal and lateral stochastic simulations. Finally, these risk curves were compared to the risk curves derived from the NASS/CDS data.

III.RESULTS

PMHS Table-top Tests

For the table-top evaluation, the predicted risk for two or more fractured ribs, for a 60yo person, ranged between 0.1% (for friction coefficient 0.05) and 30% (for friction coefficient 0.60). This can be compared to 100% risk for the two physical tests, in which the PMHS received 11 and nine fractured ribs. The distribution of predicted maximum principal strain can be seen in Fig. 5 for the three friction coefficients. A comparison of predicted impactor force and measured impactor forces can be found in Appendix B.

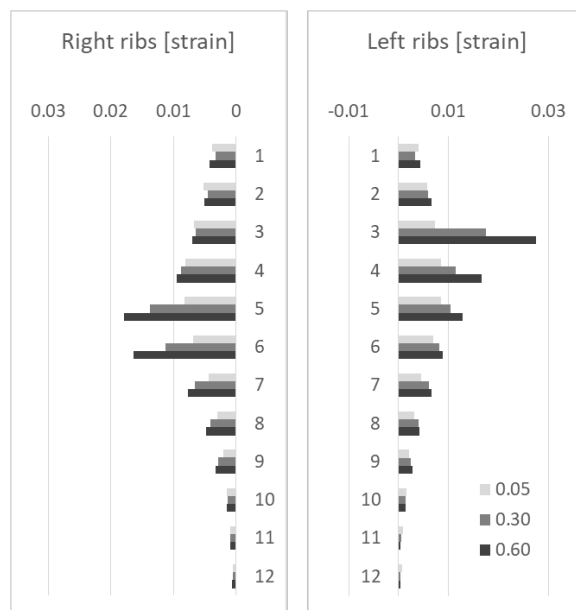

Fig. 5. Maximum strain in ribs 1 through 12, left and right halves, during Shaw [17] mid-sternum 80 mm stroke table-top test. Presented for three different friction coefficients (0.05, 0.3 and 0.6).

PMHS Sled Tests

For all the sled tests, the rib fracture risk from the PMHS tests was predicted by the SAFER HBM v. 9. In the Ford Passenger sled tests no fractures were sustained by the PMHS. In the corresponding simulations the fracture risk predicted with the SAFER HBM v. 9 model was close to zero. In the Gold Standard 1 PMHS tests with a DV of 40 km/h, all eight PMHS sustained numerous fractures. The SAFER HBM model predicted close to 100% risk for two or more fractured ribs. In the Gold Standard 2 sled tests with a DV of 30 km/h neither of the two PMHS sustained rib fractures. The SAFER HBM v. 9 model predicted a risk for two and more rib fractures close to zero. A comparison between the predicted belt forces and kinematics in the HBM sled simulations and corresponding results from the physical tests can be found in Appendix C.

Detailed Accident Reconstructions

For each reconstruction the risk for an occupant to sustain two or more fractured ribs was calculated. The rib fracture risk was adjusted to the age of the occupant. The predicted NFR2+ risks for each case are shown in Table I, including the nine occupants with chest injuries and those without chest injuries. Overall, based on the virtual detailed reconstructions, for the occupants with two or more fractured ribs the model predicted a risk of 75–97% or higher. For the occupants without rib fractures, a risk of 29% or lower was predicted for all occupants but one. For that one occupant, a 98% risk of sustaining two or more fractured ribs was predicted.

TABLE I
CHEST INJURIES AND PREDICTED RISK FOR RIB FRACTURE IN THE RECONSTRUCTIONS

Nr	Age	Chest injuries sustained by the occupants in the accident	NFR2+ Risk
1	67		0.10%
2	81	Sternum fracture (AIS2)	0.2%
3	82		1.1%
4	44		98.4%
5	44	Lung contusion (AIS3)	86.7%
6	67	1-2 rib fractures right side 1-2st (AIS2)	94.7%
7	62	1 rib fracture left side (AIS1), pneumothorax (AIS2)	76.0%
8	85	Chest contusion (AIS1), 4 rib fractures right side (AIS3), pneumothorax (AIS4)	97.0%
9	79		0.3%
10	42		21.7%
11	19	Spleen rupture (AIS3)	34.0%
12	42	9 rib fractures (AIS3), 2 sternum fractures (AIS2)	92.8%
13	46		0.0%
14	52	Chest contusion (AIS1)	6.1%
15	39		5.2%
16	37		28.0%
17	38	1 sternum fracture 1 (AIS2), chest contusion (AIS1)	0.8%
18	34		0.1%
19	42		29.9%
20	22	Bleeding left lung (AIS3)	5.8%

Population-based Accident Reconstructions

For both the frontal and lateral impact population-based reconstructions, the SAFER HBM v. 9 model predicted for a 30- and a 70yo occupant a higher risk of sustaining two and more fractured ribs than was obtained in the NASS analysis (Fig. 6 and Fig. 7). For the frontal population-based reconstructions, in particular for the 30yo, a greater injury risk was predicted (Fig. 7). The population-based simulation predicted a 50% risk for two or more fractured ribs for a DV of 60 km/h, while the 50% risk in the NASS data analysis was for a DV of 100 km/h. For a

70yo occupant the 50% risk was predicted for a DV of 50 km/h, while the 50% risk in the NASS data analysis corresponded to a DV of 65 km/h.

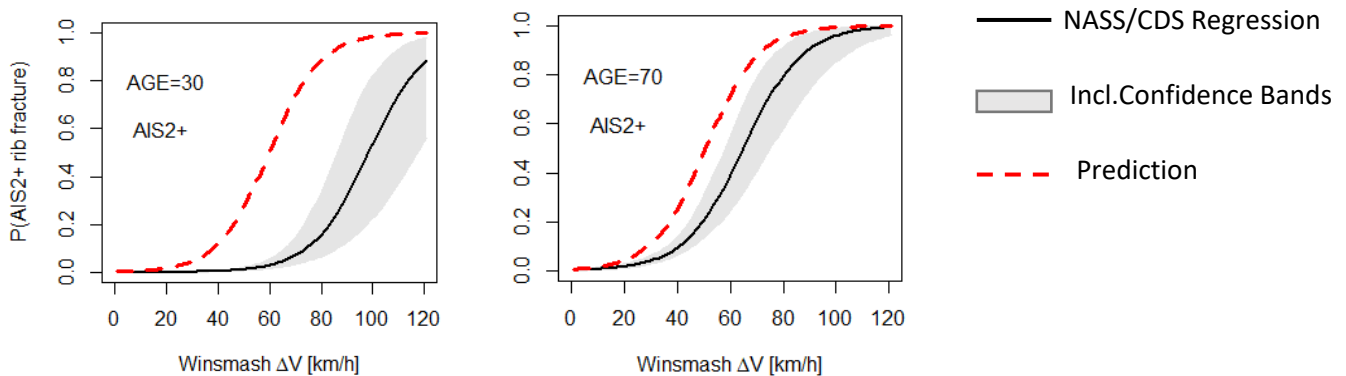

Fig. 6. NFR2+ Predictions in Frontal Impact.

For the lateral impact population-based reconstructions the predicted injury risk for a 30yo occupant was greater than the results from the NASS analysis (Fig. 7). For a 30yo occupant the predicted 50% risk for NFR2+ was at a DV of 40 km/h. In the NASS analysis the corresponding DV was 60 km/h. For a 70yo occupant the predicted risk for NFR2+ was at a DV of 35 km/h, while in the NASS analysis the corresponding DV was 45 km/h.

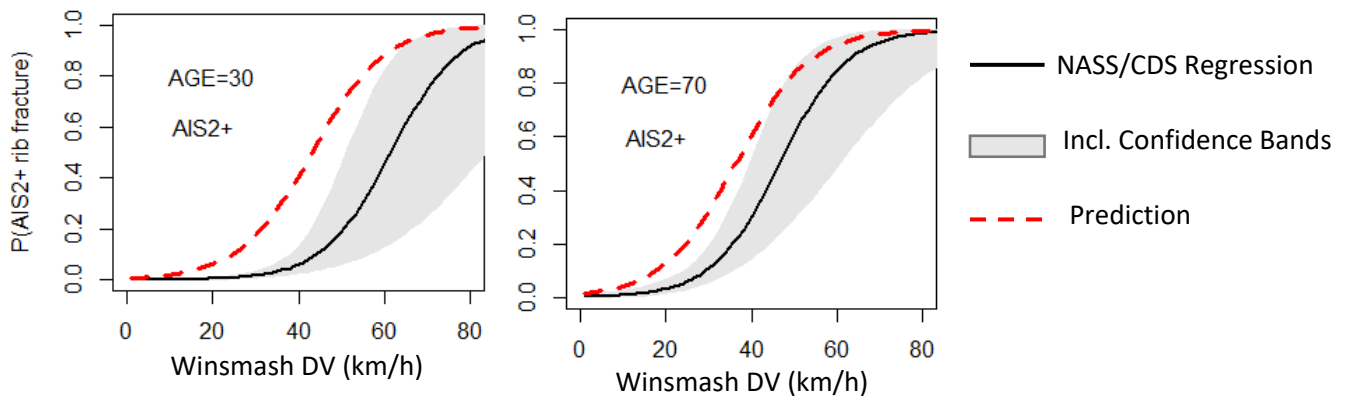

Fig. 7. NFR2+ Prediction in Lateral Impacts.

IV. DISCUSSION

The capability of the SAFER HBM v. 9 model to predict the risk for an occupant to sustain two or more fractured ribs was evaluated by means of four different methods. Three methods comprised few but very detailed comparisons between model predictions and test results, while the fourth method comprised a less detailed population-based comparison. The predictions were evaluated by means of results from both PMHS tests and injuries sustained by occupants in real vehicle crashes. The fact that the capability of the SAFER HBM v. 9 model to predict rib fracture was evaluated by numerous methods provides confidence that the model can accurately predict the risk for an occupant of sustaining two or more rib fractures in vehicle crashes.

There were advantages and disadvantages with all the methods used to validate the proposed rib fracture prediction method in this study. The advantage with the table-top test method was that the ribcage was denuded, therefore the influence on chest response from superficial tissue was removed. In addition, the loading of the ribcage was, to some extent, controlled. The disadvantage was that the loaded area of the ribcage was small and dissimilar to the area loaded by a belt. The friction between the indenter and the ribcage was not known, and the indenter was sliding across the ribcage during one of the physical tests. Therefore, the influence of friction on rib fracture risk was evaluated by varying the friction coefficient in the evaluation. There was a discrepancy between the number of fractures in the table-top tests and the rib fracture risk predicted by the SAFER HBM v. 9 model. Numerous fractures were sustained by all PMHS, while the greatest NFR2+ risk predicted by the model was 30%. One reason for this discrepancy could be the uncertainty in the boundary

conditions due to the sliding of the indenter. Another reason could be limited biofidelity of the modelling of the costal cartilage. In future ribcage validation, costal cartilage modelling will be included.

The advantage with PMHS sled test reconstructions was that a detailed comparison of the kinematics between the PMHS and the human model was carried out. Generally, there was good agreement between the predicted and measured belt forces for all 3 sled reconstructions (Appendix C). There was also good agreement between the predicted and measured kinematics for all configurations but for the head trajectory in the modified Gold Standard configurations in which the predicted head displacement was greater than the measured. In addition, a comparison between the number of fractured ribs sustained by the PMHS and the predicted rib fracture risk was also carried out. Good agreement between the predicted rib fracture risk and the rib fractures sustained by the PMHS was obtained. The disadvantage lies in the fact there is a difference between PMHS and live human when loaded in a crash. The PMHS lacks muscle tonus, which can influence the injury risk for a human when loaded.

The advantage with both the detailed reconstructions and the population-based reconstructions was that the evaluation was carried out using data from living humans. The advantage with the detailed reconstructions was that there was a validated model available for the vehicle interior, including restraint systems. In addition, detailed data for the occupant and the injuries were available. The disadvantage was that the number of cases for reconstruction was limited and only one vehicle brand was available for reconstructions. Another disadvantage was that the initial position of the occupants and the kinematics during the crash were not known.

The advantage with the population-based reconstructions was that a fleet of vehicles was evaluated. The disadvantage was that there was a limited level of detail and there were uncertainties regarding the injuries sustained by the occupants in the NASS data. The rib fracture risk can be underestimated in the NASS data. In the NASS data, rib fractures are diagnosed by CT-scans. However, several studies have shown that the true rib fracture rate is underestimated when diagnosed by CT-scans [24-26]. These studies show that the true fracture rate can be underestimated by as much as 50–70%. Another reason for the rib fracture risk being overpredicted in both frontal and lateral impacts could be that in the population-based reconstructions the various components of the restraint system were stochastically combined to make up the protection system. In a real vehicle, however, the restraint system is developed and optimised as a system, which means the properties of the various components that make up the restraint system are defined for an optimum performance of the system. This means the different components of the restraint system were not optimised as a system. The injury risk can be higher for the system with stochastically combined components than for a restraint system that is optimised as a system.

In the detailed reconstructions the model predicted a 76% risk, or higher, for the occupants who sustained two or more rib fractures. However, a high rib fracture risk of 98% and 77% was predicted for two occupants who did not sustain rib fractures. The DV for both cases was high, at 65 km/h and 75 km/h, respectively. At such high DV, it is not unlikely for an occupant to sustain injuries. However, one of those occupants sustained a lung contusion, indicating high chest loads.

Generally, the rib fractures sustained by the PMHS in the sled tests were predicted with the SAFER HBM model in the sled test reconstructions. For the detailed and population-based reconstructions, the rib fracture risk was overpredicted. For the detailed reconstructions, high injury risk was predicted for two occupants who were uninjured. In the population-based reconstructions the rib fracture risk was systematically overpredicted. An explanation for this difference could be that the biomechanical data used to develop the rib fracture risk curves were based on in vitro data and there can be a difference in tensile and fracture properties for in vivo or in vitro cortical bone. In addition, muscle tonus present in the thorax of living humans can increase the resistance of the thorax to rib fractures.

All detailed reconstructions were run with the SAFER HBM v. 9 model. Even though the virtual reconstructions were detailed representations of the vehicle crashes numerous parameters that can influence

the injury risk predictions were not included in the virtual reconstructions. Parameters such as position of the occupant in the vehicle at impact, anthropometry of the occupant and pre-crash manoeuvre of the vehicle. In seven of the cases braking was observed. In thirteen of the cases braking was unknown which means that braking may or may not have occurred. The influence on the injury risk of these parameters will be evaluated in future analysis.

However, a small investigation of the influence of anthropometry on occupant risk was carried out. Therefore, six of the occupants were morphed to the age, BMI and height of the occupant in the real-world accident [27] (Table II). The SAFER HBM model was morphed to parametric statistical human target geometries of ribcage, pelvis, femur, tibia and body shape. The parameters determining the final shape of the geometries was sex, age, stature and body mass [28]. Parts in the HBM not represented by the target geometries obtained their shape from interpolation between the HBM original and morphed shape.

TABLE II
PREDICTED AIS2+ RIB FRACTURE RISK FOR ORIGINAL AND MORPHED HUMAN BODY MODEL

Nr	Height (cm)	BMI	Original 2+ Rib Fracture Risk	Morphed Occupant 2+ Rib Fracture Risk	Chest Injury
5	165	24	86.7%	66.6%	Lung Contusion (AIS3)
8	153	26	97%	100%	Rib Fractures 4 Pneumothorax (AIS4)
9	186	26	0.3%	2.4%	-
16	163	24	39.3%	94.6%	-
17	170	31	0.8%	1.5%	Sternum Fracture (AIS2)
18	188	27	0.1%	30.0%	Contusion (AIS1)

For three of the cases, there was an influence on the predicted rib fracture risk from morphing of the SAFER HBM model to the anthropometry of the occupant involved in the crash. For the occupant with a height of 165 cm and a BMI of 24 who sustained a lung contusion, the predicted rib fracture risk was reduced from 87% to 67%. For the occupant with a height of 163 cm and a BMI of 24 the injury risk was increased from 39% to 95%. For the occupant with a height of 188 cm and a BMI of 27 the injury risk was increased from 0% to 30%. An influence on chest injury risk from morphing the SAFER HBM to the height and BMI of the occupant involved in the crash was obtained. One of the parameters that was varied was the interaction between the SAFER HBM and the seatbelt. The initial angle of the shoulder portion of the belt was altered, which influenced the performance of the seatbelt. Therefore, occupant injury risk can be influenced by the anthropometry of the vehicle occupant.

The current version of the probabilistic rib fracture tool addresses rib fractures only. However, in the field data from the Volvo car accident database three out of the 20 occupants sustained sternum fractures. Two of those occupants sustained sternum fractures without rib fractures. The capability to predict sternum fractures can be included in future developments of the probabilistic rib fracture prediction method.

V. CONCLUSIONS

The SAFER HBM, combined with the probabilistic rib fracture prediction method, can accurately predict the risk of AIS2+ rib fractures for load cases with controlled boundary conditions such as PMHS table top and sled tests. For load cases with less controlled boundary conditions such as detailed accident reconstructions and population-based reconstructions the rib fracture predictions were less accurate. The systematic overprediction of the rib fracture risk in the population-based reconstructions could be due to underestimation of the true rib fracture risk in the field data. Varying the body size of the SAFER HBM by morphing influenced the risk for an occupant to sustain rib fracture.

VI. ACKNOWLEDGEMENTS

The project was carried out at SAFER – Vehicle and Traffic Safety Centre at Chalmers, Sweden, and financed by FFI (Strategic Vehicle Research and Innovation), by VINNOVA, the Swedish Transport Administration, the Swedish Energy Agency and the industrial partners. The project partners are Chalmers University of Technology, Autoliv Research, Sahlgrenska Hospital and Volvo Cars. The authors acknowledge Jacob Wass, Claes Ljungqvist, Eric Sandborg and Jonas Östh from Volvo Cars and Leila Jaber from Autoliv Research for carrying out the detailed accident reconstructions.

VII. REFERENCES

- [1] Rouhana, S. W., Bedewi, P. G. and Prasad, P. (2003) Biomechanics of 4-Point Seat Belt Systems in Frontal Impact. *Stapp Car Crash Proceedings*, **47** 2003.
- [2] Trosseille, X., Baudrit, P., Leport, T., Vallancien, G. (2008) Rib cage strain pattern as a function of chest loading configuration. *Stapp Car Crash Proceedings*, **52**: pp.205–31.
- [3] Forman, J., *et al.* (2012) Predicting Rib Fracture Risk with Whole-Body Finite Element Models: Development and Preliminary Evaluation of a Probabilistic Analytical Framework. *Proceedings of the 56th AAAM Annual Conference on Annals of Advances in Automotive Medicine*, 2012, **56**: pp. 102–24.
- [4] Toyota Central R&D Labs. INC. Human Body Models for Injury Analysis THUMS®. Available at: <https://www.tytlabs.com/tech/thums/index.html>. Accessed 26 November 2018.
- [5] Elemance. Virtual Human Body Models. Available at: <http://www.elemance.com/virtual-human-body-models/>. Accessed 26 November 2018.
- [6] Iraeus, J., Lindquist, M. (2014) Influence of Vehicle Kinematic Components of Chest Injury in Frontal Offset Impacts. *Traffic Injury Prevention*, **15**.
- [7] Mendoza-Vasques, M. (2014) Thoracic injuries in frontal car crashes: risk assessment using a finite element human body model. PhD Thesis, Chalmers University of Technology, Sweden.
- [8] Shigeta, K., Kitagawa, Y., Yasuki, T. (2009) Development of next generation human FE model capable of organ injury prediction. *Proceedings of the 21st Annual Enhanced Safety of Vehicles*, 2009.
- [9] Schoell, S. L., *et al.* (2015) Development and Validation of an Older Occupant Finite Element Model of a Mid-Sized Male for Investigation of Age-related Injury Risk. *Stapp Car Crash Journal*, **59**: pp. 359–83.
- [10] Schoell, S. L., Weaver, A. A., Vavalle, N. A., Stitzel, J. D. (2015) Age- and sex-specific thorax finite element model development and simulation. *Traffic Injury Prevention*, **16**(sup1): pp. S57–S65.
- [11] Iraeus, J., Brolin, K., Pipkorn B. (2019) Generic finite element models of Human Ribs, developed and validated for fracture prediction. *Journal of Mechanical Behaviour of Biomedical Materials*, submitted March 2019.
- [12] Pipkorn, B., Kent, R. (2011) Validation of a human body thorax model and its use for force, energy and strain analysis in various loading conditions. *Proceedings of the International Research Council on the Biomechanics of Injury (IRCOBI) conference*, September 2011, Krakow, Poland.
- [13] Pipkorn, B., Mroz, K. (2008) Validation of a human body model for frontal crash and its use for chest injury prediction. *Digital Human Body Model Conference*, 2008, SAE Paper 08DHM-0015, Pittsburgh, USA.

- [14] Iraeus, J., Lindquist, M. (2016) Development and validation of a generic finite element vehicle buck model for the analysis of driver rib fractures in real life nearside oblique frontal crashes. *Accident Analysis & Prevention*, **95**(Part A): pp. 42–56.
- [15] Iraeus, J., Pipkorn, B. (2019) Multi-Scale Validation of Rib Strain in Human Body Models. *International Research Council on the Biomechanics of Injury (IRCOBI) conference*, submitted 2019.
- [16] Shaw, C. G., Lessley, D., Evans, J., Crandall, J., Shin, J. (2007) Quasi-static and dynamic thoracic loading tests: cadaveric torsos. *Proceedings of the International Research Council on the Biomechanics of Injury (IRCOBI) conference*, September 2007, Maastricht, The Netherlands.
- [17] Shaw, C. G., Lessley, D., Crandall, J. (2007) Quasi-Static and Dynamic Thoracic Loading Tests: Cadaveric Torsos. A Report Prepared for NHTSA, Cooperative Agreement No. DTNH22-93-Y-07028: Virginia, USA.
- [18] Forman, J., Lessley, D., Kent, R., Boström, O., Pipkorn, B. (2006) Whole-body Kinematic and Dynamic Response of Restrained PMHS in Frontal Sled Tests. *Proceedings of Stapp Car Crash Proceedings* **50**, Dearborn, USA.
- [19] Shaw, G., *et al.* (2009) Impact Response of Restrained PMHS in Frontal Sled Tests: Skeletal Deformation Patterns Under Seat Belt Loading. *Proceedings of Stapp Car Crash Proceedings*, **52**, Savannah, USA.
- [20] Crandall, J. (2015) ATD Thoracic Response Test Development Gold Standard Buck Condition 2: Force Limited Belt, 30 km/h Frontal Impact. A Report Prepared for NHTSA, Cooperative Agreement No. DTNH22-09-H-00247, Washington D.C., USA.
- [21] Isaksson-Hellman, I., Norin, H. (2005) How thirty years of focused safety development has influenced injury outcome in Volvo cars. *Proceedings of the AAAM Annual Conference on Annals of Advances in Automotive Medicine*, Boston (Cambridge), USA
- [22] R Core Team (2015) R: A language and environment for statistical computing. R Foundation for Statistical Computing, Vienna, Austria. URL <https://www.R-project.org/>
- [23] Lumley, T. (2016) "Survey: analysis of complex survey samples". R package version 3.31-2.
- [24] Crandall, J., Kent, R., Patrie, J., Fertile, J., Marin, P. (2000) Rib fracture patterns and radiologic detection – a restraint-based comparison. *Proceedings of the AAAM Annual Conference on Annals of Advances in Automotive Medicine*, Chicago, USA
- [25] Lederer, W., Mair, D., Rabi, W., Baubin, M. (2004) Frequency of rib and sternum fractures associated with out-of-hospital cardiopulmonary resuscitation is underestimated by conventional chest x-ray. *Resuscitation*, **60**(2): pp. 157–62.
- [26] Schulze, C., *et al.* (2013) Rib fractures at postmortem computed tomography (PMCT) validated against the autopsy. *Forensic Science International*, **233**(1): pp.90–98.
- [27] Hwang, J., *et al.* (2016) Rapid Development of Diverse Human Body Models for Crash Simulations through Mesh Morphing. *SAE Technical Paper 2016-01-1491*; doi 10.4271/2016-01-1491.
- [28] Zhang, K., *et al.* (2017) An automated method to morph finite element whole-body human models with a wide range of stature and body shape for both men and women. *Journal of Biomechanics*, **60**: pp. 253–60

VIII. APPENDIX

A. Modifications to the THUMS v3 model

Body Part		Modification
Chest	Ribs	<p>Geometry and mesh modified Shi, X., Cao, L., Reed, M. P., Rupp, J. D., Hoff, C. N., Hu, J. (2014) A statistical human rib cage geometry model accounting for variations by age, sex, stature and body mass index. <i>Journal of Biomechanics</i>, 47(10): pp. 2277–85.</p> <p>Cortical bone thickness modified Choi, H-Y, Kwak, D-S (2011) Morphologic Characteristics of Korean Elderly Rib. <i>Journal of Automotive Safety and Energy</i>, 2.</p> <p>Cortical bone properties modified Kemper, A. R., <i>et al.</i> (2005) Material properties of human rib cortical bone from dynamic tension coupon testing. <i>Stapp Car Crash Journal</i>, 49: pp. 199–230. Kemper, A. R., <i>et al.</i> (2007) The biomechanics of human ribs: material and structural properties from dynamic tension and bending tests. <i>Stapp Car Crash Journal</i>, 51: pp. 235–73.</p>
	Sternum	<p>Geometry and mesh modified 50th percentile male sternum Weaver, A. A., Schoell, S. L., Nguyen, C. M., Lynch, S. K., Stitzel, J. D. (2014) Morphometric analysis of variation in the sternum with sex and age. <i>Journal of Morphology</i>, 275(11): pp. 1284–99.</p>
Lumbar Spine	Vertebra	<p>Remeshed Contact between vertebra and intervertebral disc added Intervertebral ligaments modified – both geometry and properties Afwerki, H. (2016) Biofidelity Evaluation of Thoracolumbar Spine Model in THUMS. Master’s Thesis in Biomedical Engineering, Chalmers University of Technology, 2016.</p>
Head		<p>New Head Model Kleiven, S. (2007) Predictors for Traumatic Brain Injuries Evaluated through Accident Reconstructions. <i>Stapp Car Crash Journal</i>, 51: pp. 81–114.</p>

B. Comparison of impactor force in the table-top load case

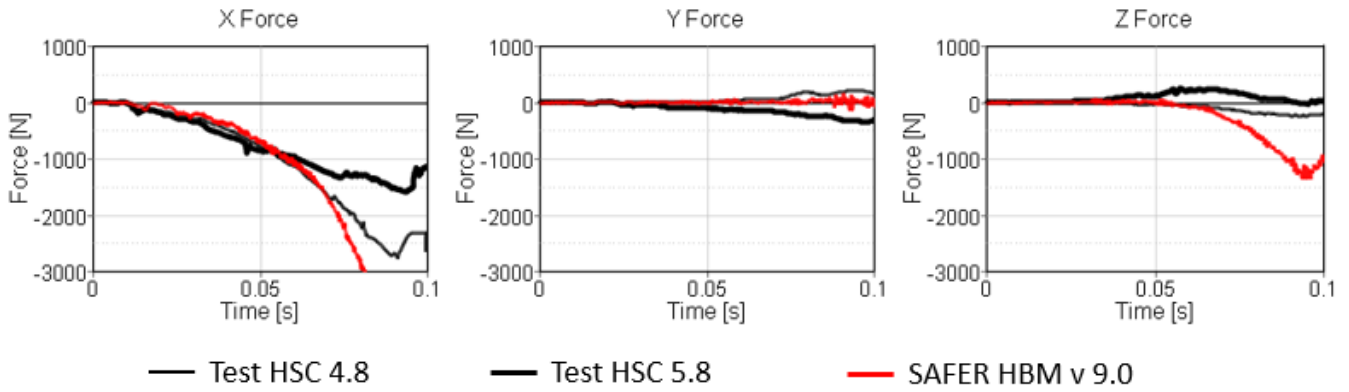

Fig. B - 1. Comparison of test and simulation impactor forces in the table top load case.

C. HBM kinetics and kinematics in sled tests

Forman et al. (2006)

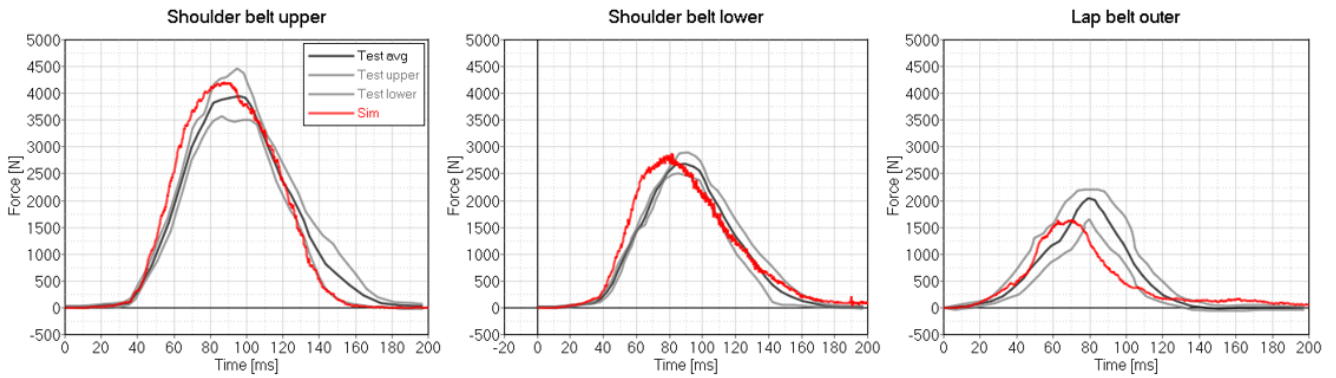

Fig. C- 1. Comparison of belt forces in Forman et al. (2006) sled test setup

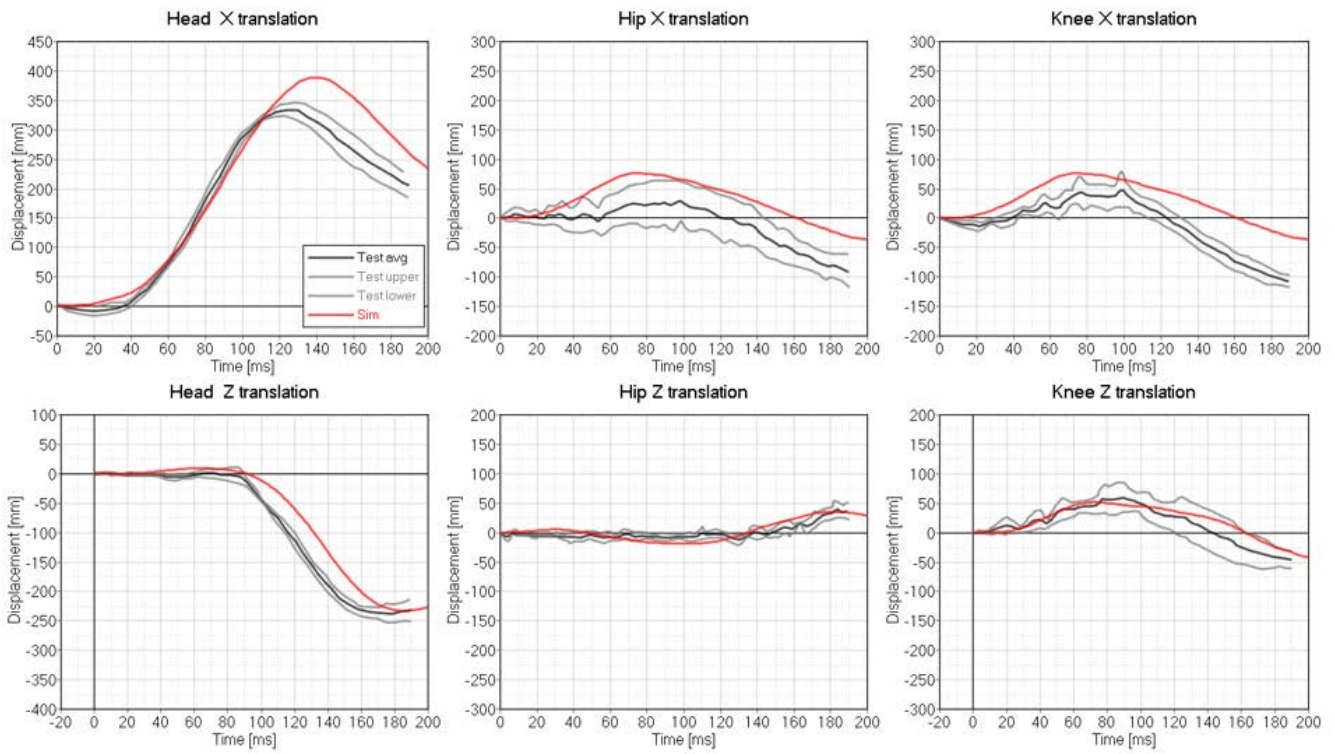

Fig. C- 2. Comparison of occupant kinematics in Forman et al. (2006) sled test setup

Shaw et al. (2009)

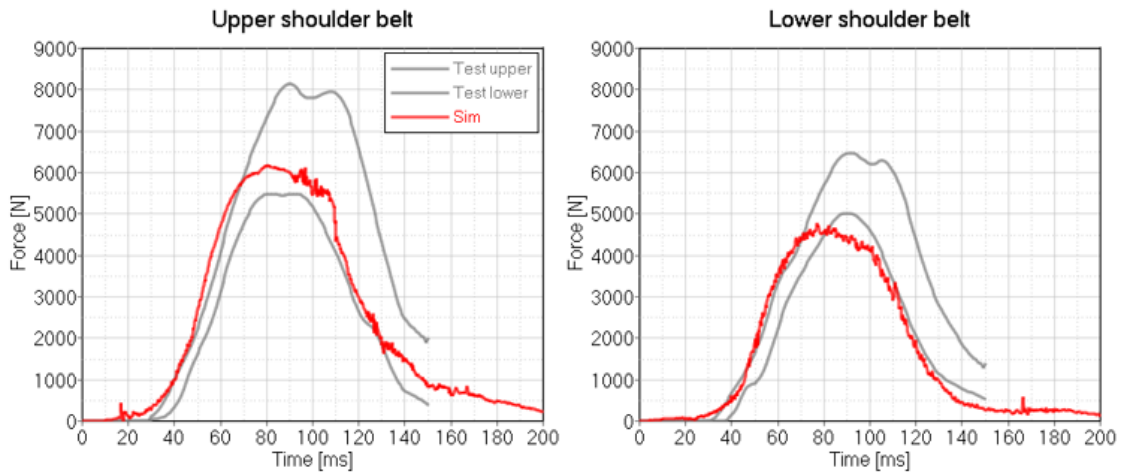

Fig. C- 3. Comparison of belt forces in Shaw et al. (2009) sled test setup

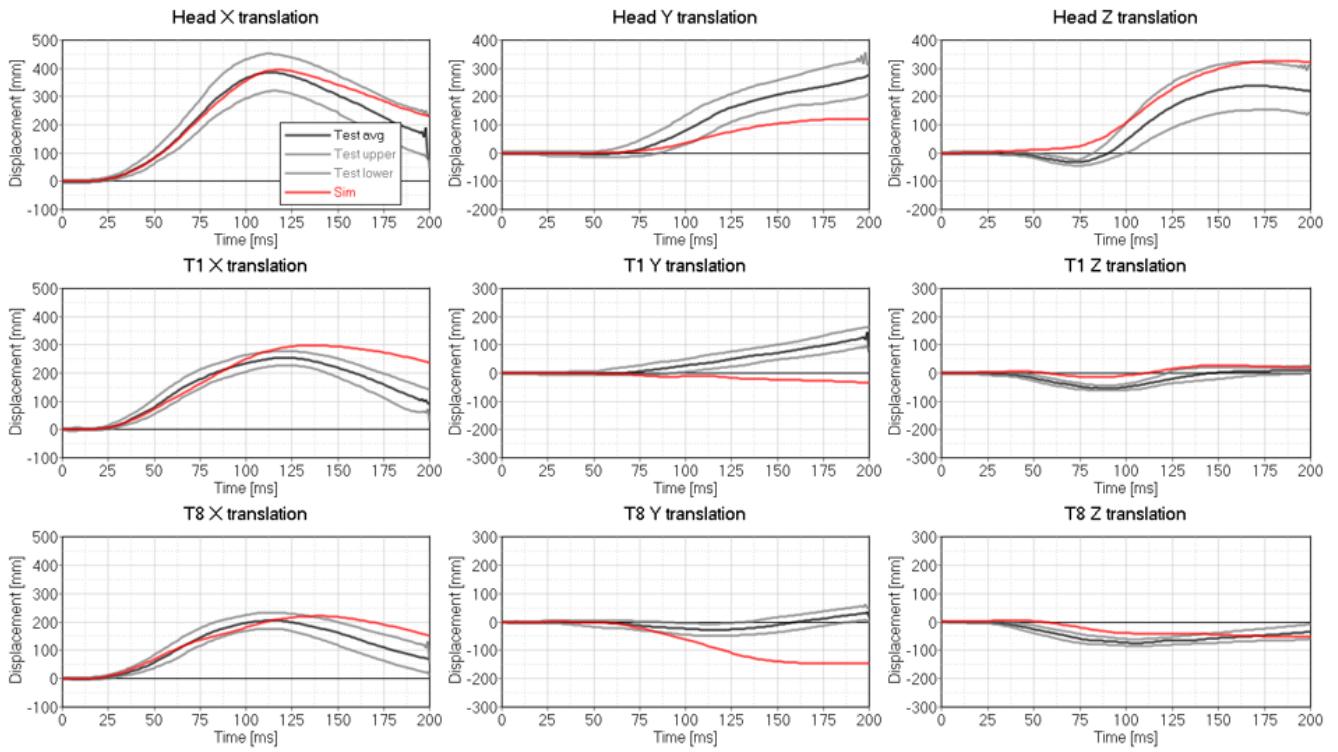

Fig. C- 4. Comparison of occupant kinematics in Shaw et al. (2009) sled test setup

Crandall (2011)

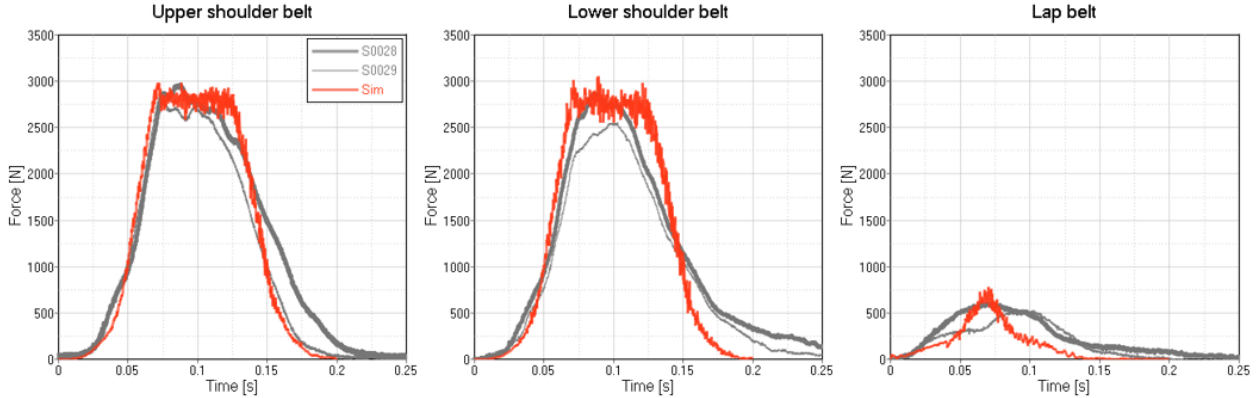

Fig. C- 5. Comparison of belt forces in Crandall (2011) sled test setup

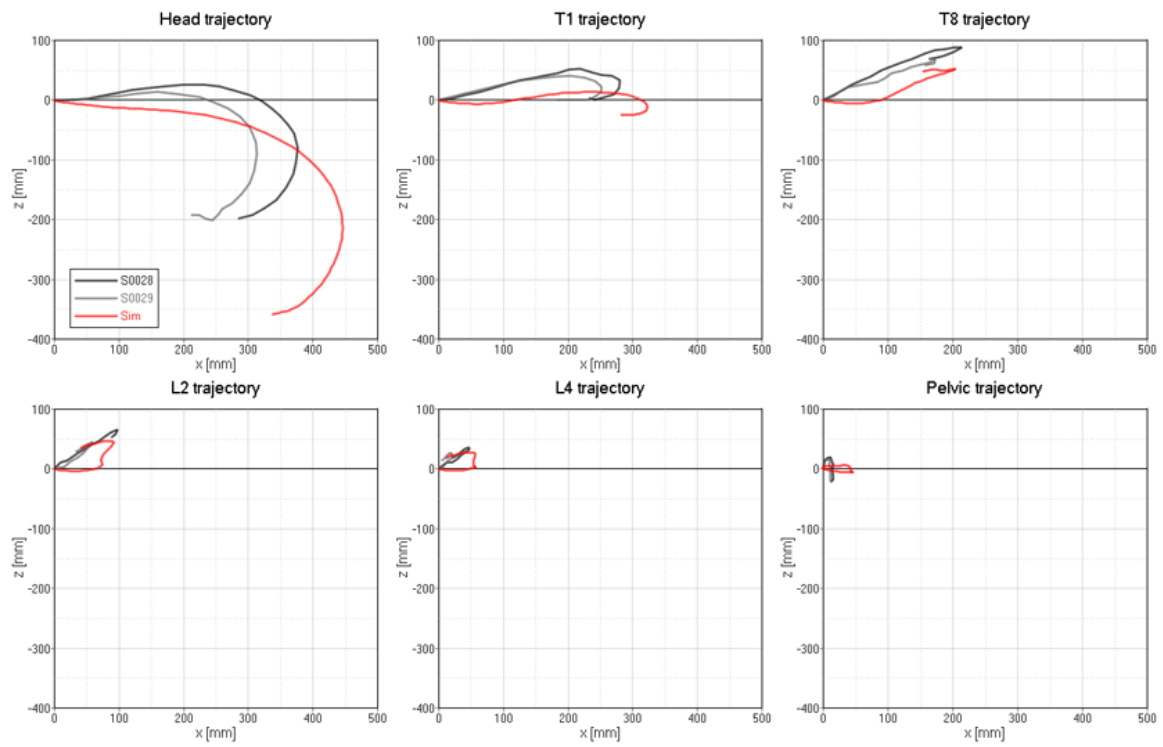

Fig. C- 6. Comparison of occupant kinematics in Crandall (2011) sled test setup

D. Detailed reconstruction cases

TABLE BI
DETAILED RECONSTRUCTION CASES

	Sex	Position	Age	Height (cm)	Weight (kg)	BMI	Impact Type	DV (km/h)	Overlap (%)	Direction	Braking	Maximum Chest Injury (AIS)	MAIS Overall
1	Male	Driver	67	178	79	25	Frontal	49	25	12	Unknown	-	MAIS2
2	Male	Driver	81	-	84	-	Frontal	53	25	11	Yes	Sternum fracture (AIS2)	MAIS2
3	Female	Passenger	82	-	70	-	Frontal	53	25	11	Yes	-	MAIS1
4	Male	Driver	44	180	80	25	Frontal	58	80	12	Yes	-	MAIS3
5	Male	Driver	44	165	65	24	Frontal	53	30-50	11	Unknown	Lung contusion (AIS3)	MAIS3
6	Male	Driver	67	-	-	-	Frontal	77	100	-	Unknown	Rib fractures 1-2 (AIS2)	MAIS2
7	Female	Passenger	62	-	-	-	Frontal	83	30-50	11	Unknown	Pneumothorax (AIS2)	MAIS2
8	Female	Rear Seat	85	153	61	26	Frontal	83	30-50	11	Unknown	Rib fractures 4 Pneumothorax (AIS4)	MAIS4
9	Male	Driver	79	186	91	26	Frontal	42	30	-	Unknown	-	MAIS1
10	Male	Driver	42	-	-	-	Frontal	64	34	11	Unknown	-	MAIS2
11	Male	Driver	19	-	-	-	Side	75	-	-	Unknown	Spleen rupture (AIS3)	MAIS3
12	Male	Driver	42	170	80	28	Frontal	70	65	9	Unknown	Rib fractures 9 (AIS3)	MAIS3
13	Male	Driver	46	-	-	-	Frontal+Run-Off	34	80	12	Unknown	-	MAIS2
14	Female	Driver	52	168	67	24	Frontal	54	70	11	Yes	Contusion (AIS1)	MAIS1
15	Male	Driver	39	182	70	21	Frontal	64	65	-	Yes	-	-
16	Female	Passenger	37	163	63	24	Frontal	64	65	-	Unknown	-	MAIS2
17	Female	Driver	38	170	90	31	Frontal+Run-Off	39	20	11	Yes	Sternum fracture (AIS2)	MAIS2
18	Male	Passenger	34	188	94	27	Frontal+Run-Off	39	20	11	Yes	Contusion (AIS1)	MAIS2
19	Male	Driver	42	-	-	-	Frontal	65	-	-	Unknown	-	MAIS2
20	Male	Driver	22	-	-	-	Frontal	90	Mid (Tree)	-	Unknown	Interior bleeding (AIS3)	MAIS3