

(19)



(11)

EP 3 115 149 B1

(12)

EUROPEAN PATENT SPECIFICATION

(45) Date of publication and mention of the grant of the patent:
14.03.2018 Bulletin 2018/11

(51) Int Cl.:
B24B 5/42 (2006.01) B24B 51/00 (2006.01)

(21) Application number: **15175782.0**

(22) Date of filing: **08.07.2015**

(54) METHOD OF GRINDING A WORKPIECE HAVING A CYLINDRICAL BEARING SURFACE AND METHOD FOR DETERMINING PROCESSING PARAMETERS

VERFAHREN ZUM SCHLEIFEN EINES WERKSTÜCKS MIT EINER ZYLINDERLAGERFLÄCHE SOWIE VERFAHREN ZUR BESTIMMUNG VON VERARBEITUNGSPARAMETERN

PROCÉDÉ DE MEULAGE D'UNE PIÈCE AYANT UNE SURFACE DE PALIER CYLINDRIQUE ET PROCÉDÉ DE DÉTERMINATION DE PARAMÈTRES DE TRAITEMENT

(84) Designated Contracting States:
AL AT BE BG CH CY CZ DE DK EE ES FI FR GB GR HR HU IE IS IT LI LT LU LV MC MK MT NL NO PL PT RO RS SE SI SK SM TR

- **ROININEN, Roope**
151 44 Södertälje (SE)
- **DRAZUMERIC, Radovan**
1215 Medvode (SI)

(43) Date of publication of application:
11.01.2017 Bulletin 2017/02

(74) Representative: **Scania CV AB**
Patents, GP 117kv
151 87 Södertälje (SE)

(73) Proprietor: **Scania CV AB**
151 87 Södertälje (SE)

(56) References cited:
US-B1- 6 878 043

(72) Inventors:
 • **KRAJNIK, Peter**
41713 Göteborg (SE)

EP 3 115 149 B1

Note: Within nine months of the publication of the mention of the grant of the European patent in the European Patent Bulletin, any person may give notice to the European Patent Office of opposition to that patent, in accordance with the Implementing Regulations. Notice of opposition shall not be deemed to have been filed until the opposition fee has been paid. (Art. 99(1) European Patent Convention).

Description**Technical field**

5 **[0001]** The present disclosure relates in general to a method of grinding a workpiece by means of a grinding wheel, the workpiece comprising a cylindrical bearing surface, a radially extending sidewall extending outward from the cylindrical bearing surface, and a curved transition portion connecting the cylindrical bearing surface with the sidewall. The present disclosure also relates to a method for determining processing parameters of such a grinding method.

10 **Background**

[0002] A crankshaft 1 has a rotational axis A and comprises a plurality of crankpins 2 or journals, as shown in Figure 1a. Figure 1b illustrates a cross sectional view of a part of such a crankpin 2. The crankpin 2 comprises a cylindrical bearing surface 3, a radially extending sidewall 4 and normally a curved portion 5. The cylindrical bearing surface 3 has a centre axis which is parallel to the axis of rotation of the crankshaft. The sidewalls are arranged at opposite axial ends of the cylindrical bearing surface and connected to the cylindrical bearing surface via a respective curved portion 5 having a radius in a plane coinciding with the plane in which the axis of the cylindrical bearing surface is arranged. The sidewalls each extend around the whole circumference of the cylindrical bearing surface and thus have a form of a cylindrical surface around the centre axis of the cylindrical bearing surface.

20 **[0003]** Forged steel crankshafts are sensitive to grinding-induced thermal damage which may result in inferior quality of the crankshaft. The common types of thermal damage to the workpiece are grinding burn (oxidation burn), metallurgical phase transformations, softening (tempering) of the surface layer with possible rehardening, unfavourable residual tensile stresses, cracks, and reduced fatigue strength. This has for example been reported by Malkin and Guo, CIRP Annals - Manufacturing Technology, Volume 56, Issue 2, 2007, Pages 760-782. Thus, grinding of the crankpin is critical since it affects the dimensions, the surface quality, and the fatigue life not only of the cylindrical bearing surface but also of the curved portions and the sidewalls. Furthermore, grinding of crankpins often result in non-uniform grinding wheel wear, which in turn also may affect the quality of the crankshaft.

25 **[0004]** It is previously known to grind a crankpin by plunge grinding using a grinding wheel having a width corresponding to the width of the pin to be ground, and a grinding wheel profile with a corner radius equal to the radius of the curved portion between the cylindrical bearing surface and the sidewall. Thus, during grinding, the sidewalls are ground simultaneously.

This method, however, has the disadvantages of non-uniform grinding wheel wear and great risk for thermally-induced damage to the crankpin. Therefore, other grinding strategies have also been developed wherein the grinding is not only performed by radial feed of the grinding wheel.

35 **[0005]** Another method for grinding of crankpins is a combined radial-plunge, axial-grinding method wherein for the majority of the process the grinding wheel plunges radially into the crankpin, followed by angle-plunge grinding during finishing. In this method, the grinding wheel width is smaller than the distance between the two sidewalls. This combined radial-plunge axial-grinding method may suffer from certain drawbacks inter alia because the grinding wheel is plunged radially. For example, if the grinding parameters are selected such as to avoid grinding burn the grinding cycle times become long. If shorter grinding cycle times are desired, the risk for grinding burn increases greatly. Furthermore, such grinding involves a high aggressiveness number and high, non-uniform, grinding wheel wear.

40 **[0006]** Yet another grinding method is the so called angle-plunge grinding method, wherein the grinding wheel plunges into the crankpin both radially and axially at an angle, typically to carry out grinding at an angle of the grinding wheel feed selected so that the sidewall grind will be completed ahead of the grind of the cylindrical bearing surface. EP 1 635 989 B1 discloses an example of such a process.

45 **[0007]** Furthermore, US 4,603,514 A discloses a method of grinding a workpiece having a cylindrical portion, two sidewall portions and curved portions connecting the cylindrical portion with the respective sidewalls, such as crankshaft pins or journals. Grinding is performed by means of a grinding wheel having a width smaller than the space between the two sidewalls of the workpiece. During grinding, the grinding wheel and the workpiece are simultaneously moved relative towards each other in two perpendicularly intersecting directions such that one sidewall and part of the cylindrical portion of the workpiece are shaped by oblique feed grinding, followed by a similar grinding operation on the other side wall and the remainder of the cylindrical portion. Such angled-vector grinding is essentially cylindrical grinding utilizing a rotationally symmetrical grinding wheel of an arbitrary profile, where the rotational axes of the wheel and the workpiece are parallel.

55 **[0008]** Angle-plunge grinding is a fundamentally better process compared to radial-plunge grinding, giving shorter grinding cycle times and less risk of burn. However, a serious drawback of angle-plunge grinding is the possibility of large surges in material removal rate when there is a large degree of run-out in the incoming crankpin dimensions. In addition, although angle-plunge grinding is an inherently better process, where the fundamental grinding parameters

are not explicitly understood or quantified. On the contrary, grinding parameters are chosen arbitrarily based on trial-and-error, resulting in regions of the crankpin with high temperatures and other regions with low temperatures.

Irrespective of the grinding method chosen, grinding of a crankpin is not easy to control. Sidewall grinding experiences extreme variation of aggressiveness number along the wheel profile as well as a longer cutting-path length compared to grinding a cylindrical surface. Therefore, one portion of the grinding wheel experiences a high aggressiveness number, causing excessive wheel wear and poor surface finish (high surface roughness) of the workpiece, while another portion of the wheel experiences a low aggressiveness number, causing high temperatures which can lead to thermal damage of the workpiece.

Oliveira et al., CIRP Annals - Manufacturing Technology, Volume 54, Issue 1, 2005, Pages 269-272, discuss axial- or radial-grinding strategies employed to grind a crankpin sidewall. In the axial feed the grinding wheel is moved axially relative to the crankshaft, whereas in the radial feed the wheel is plunged perpendicularly towards the crankshaft rotating axis. Oliveira et al. concluded inter alia that it is possible to determine the most affected areas of the wheel profile according to each of the grinding strategies applied and based on said information selecting the most suitable grinding strategies and grinding conditions in order to reduce the thermal damage and wheel wear. Furthermore, it was concluded that a multi-step axial face grinding strategy provides a flexible solution for process design and that according to the number of steps selected it is possible to adjust the specific material removal rate and the position of maximum wear along the wheel profile, thereby achieving better control of the process.

A crankpin is eccentric to the shaft main rotational axis, which requires moving the rotating grinding wheel (wheelhead) in a direction of the crankpin according to a rotation phase of the crankshaft. Such accommodation of a radial feed can be done by traversing a grinding spindle in the radial direction towards the workpiece (X-axis) by means of CNC. The axial feed is realized by a CNC-controlled Z-axis, independent of X-axis. This is for example disclosed in US 6,878,043 B1. The document forms the basis for the preamble of claim 1. Furthermore, when a crankshaft rotates with a constant rotational speed the relative workpiece speed is changing according to a rotation phase of the crankshaft continuously as the grinding wheel passes around the circumference of the workpiece.

[0009] While the problems associated with crankpin grinding has been disclosed above, the same applies to other workpieces comprising a cylindrical bearing surface, a sidewall and a curved transition portion.

Summary

[0010] The object of the present invention is to enable a grinding method of a workpiece by means of a grinding wheel, the workpiece comprising a cylindrical bearing surface, at least one sidewall extending radially outwardly from an axial end of the cylindrical bearing surface, and a curved transition region connecting the cylindrical bearing surface with said at least one sidewall, wherein the grinding method results in high productivity rates and controlled quality of the workpiece in terms of avoiding thermal damage, and which grinding method can be industrially implemented.

[0011] The object is achieved by a grinding method according to claim 1 and a method for determining process parameters of a grinding method according to claim 6. Exemplifying embodiments are defined by the dependent claims.

[0012] The workpiece may for example be a crankpin of a crankshaft, but is not limited thereto. The workpiece may be any workpiece comprising a cylindrical bearing surface, a curved portion, as well as a sidewall extending radially outwardly from an axial end of the cylindrical bearing surface and connected to the cylindrical bearing surface by means of the curved portion.

[0013] The present invention is based on grinding the workpiece by controlling the depth of cut during each increment such that the points on the grinding wheel profile causing the highest surface temperature of the workpiece remain below or at a pre-set maximum surface temperature of the workpiece. Thus, the surface temperature of the workpiece can never be higher than the pre-set maximum surface temperature threshold and thus thermal damages of the workpiece are avoided. Furthermore, by controlling the depth of cut for each increment of the grinding cycle in accordance with the set surface temperature results in the lowest number of increments needed to grind the workpiece and thus inherently also the lowest grinding cycle time. Thereby, grinding can be performed in a controlled manner at high productivity rates without any risk for thermal damage of the workpiece caused by the grinding and hence controlled quality of the workpiece is achieved.

[0014] In accordance with the present invention, a method of grinding a workpiece by means of an essentially rotational symmetrical grinding wheel is provided, wherein the workpiece comprises a cylindrical bearing surface, a radially extending sidewall extending outward from the cylindrical bearing surface, and a curved transition portion connecting the cylindrical bearing surface with the sidewall, and wherein the grinding wheel has an axial extension less than the axial extension of the cylindrical bearing surface. The method comprises grinding the workpiece in a plurality of grinding increments together defining a grinding cycle, each grinding increment performed with a respective feed of the grinding wheel in relation to the workpiece. In each separate grinding increment, the feed is selected so as to achieve a pre-set maximum surface temperature of the workpiece at a point of the grinding wheel resulting in the highest surface temperature of the workpiece.

[0015] The feed may suitably comprise an axial feed and a radial feed, which are independently selected so as to achieve said pre-set maximum surface temperature of the workpiece at the point of the grinding wheel resulting in the highest surface temperature of the workpiece. Thus, the grinding method may suitably be an angle-plunge grinding process. This has the advantage of giving shorter cycle times compared to for example a process wherein, for the majority of the process, the grinding wheel plunges radially into the workpiece. The axial feed and radially feed are preferably set so as to achieve a maximum material removal rate in each grinding increment.

[0016] For sake of simplicity of control of the process, the grinding wheel may suitably be rotated with a constant rotational speed.

[0017] Furthermore, the workpiece may suitably be rotated with a constant rotational speed throughout the grinding cycle in order to achieve an easy control of the process. It is however also possible to rotate the workpiece with a constant rotational speed within each increment, but with different rotational speeds in two of each other following increments. Depending on the apparatus used, it may also be possible to vary the rotational speed within an increment if desired.

[0018] The present invention also provides a method of determining processing parameters of a grinding method for grinding a workpiece by means of an essentially rotational symmetrical grinding wheel having a grinding wheel profile. The workpiece comprises a cylindrical bearing surface, a radially extending sidewall extending outward from the cylindrical bearing surface, and a curved transition portion connecting the cylindrical bearing surface with the sidewall, and wherein the grinding wheel has an axial extension less than the axial extension of the cylindrical bearing surface. The method comprises, based on a pre-set maximum surface temperature, determining a number of increments and the respective axial feed and radial feed of said increments, and comprises the following steps:

- a) based on a position of the grinding wheel at the end of the grinding cycle, determining the distance into the workpiece in radial respectively axial direction and hence determine the corresponding contact portion set by a lower limit and an upper limit (of the grinding wheel profile;
- b) determining an axial feed and a radial feed, in a corresponding increment, necessary to keep the pre-set maximum surface temperature at a point of the contact portion of the grinding wheel resulting in a highest surface temperature of the workpiece during said corresponding increment;
- c) based on the axial feed and the radial feed determined in step b) determining the resulting grinding wheel position after completion of one increment with said axial feed and radial feed,
- d) based on the grinding wheel position obtained in step c) determining a corresponding contact portion with a corresponding lower limit and upper limit of the grinding wheel profile;
- e) in case the lower limit of the contact portion is less than the upper limit of the contact portion obtained in step d) repeating steps b) to d) until the lower contact limit of the contact portion is not less than the upper limit;
- f) indexing the obtained increments and their respective axial feed and radial feed according to the grinding process.

[0019] Determining the axial feed and radial feed necessary to keep the pre-set maximum surface temperature at a point of the contact portion of the grinding wheel resulting in a highest surface temperature of the workpiece in step b) may suitably be performed such as to achieve a maximum removal rate in the increment. This further ensures a shortest possible grinding cycle without any risk for thermal damage.

[0020] The axial feed and the radial feed may be determined in step b) by calculating a limit depth of cut function of the grinding wheel position in order to match the pre-set maximum surface temperature, and further comprising selecting two critical points of the limit depth of cut function in the current contact interval. Said critical points are then used to determine the corresponding axial feed and radial feed. Thereby the pre-set maximum surface temperature is matched only in two points of the contact interval and everywhere else, the actual depth of cut will be lower.

[0021] The limit depth of cut function may be given as:

$$\theta^* = \frac{1.064}{\sqrt{k\rho c_p}} e_w [aggr(s, a_e^*)] \sqrt{\frac{v_s}{10^6} a_e^* aggr(s, a_e^*)} \Rightarrow a_e^* = a_e^*(s, \theta^*) \quad (\text{Eq. 22})$$

wherein θ^* is the pre-set maximum surface temperature, k is the thermal conductivity of the workpiece material, ρ the density of the workpiece material, c_p is the specific heat of the workpiece material, e_w is the specific energy into the workpiece, v_s is the grinding wheel speed, and $aggr$ is the aggressiveness number.

[0022] The total specific energy characteristic, $e_{tot}(aggr)$, may for example be obtained from grinding power measurements (i.e. experiments) performed in a first step comprising only sidewall grinding wherein only axial feed is used, and a second step comprising only cylindrical bearing surface grinding wherein only radial feed is used, and wherein the total specific energy in the transition region is obtained by exponential interpolation. The specific energy into the workpiece characteristic $e_w(aggr)$ is then determined by calculating energy partition ratios and applying them to the total specific energy characteristic for each grinding type (i.e. grinding of sidewall only and grinding of cylindrical bearing surface only)

separately, and wherein the specific energy in the transition region is again obtained by exponential interpolation.

[0023] According to an aspect of the present invention, a computer programme for determining processing parameters of a grinding method is provided, which computer programme comprises programme code for performing the method steps of the method for determining processing parameters as disclosed above.

[0024] According to an aspect of the present invention, a computer programme for determining processing parameters of a grinding method is provided, which computer programme comprises programme code stored on a computer-readable medium for performing the method steps of the method for determining processing parameters as disclosed above.

[0025] The computer programme may further be arranged to provide the determined processing parameters to an electronic control unit or another computer connected to or adapted to communicate with the electronic control unit.

[0026] The electronic control unit can for example be an electronic control unit of a grinding machine adapted to control parameters such as the axial feed and radial feed, as well as the number of increments.

[0027] According to an aspect of the present invention, a computer programme product is provided containing a programme code stored on a computer readable medium for performing the method of determining processing parameters of a grinding method as disclosed above when said computer programme is run on an electronic control unit or another computer connected to or adapted to communicate with the electronic control unit.

Brief description of drawings

[0028]

Fig. 1 a schematically illustrates a side view of a crankshaft.

Fig. 1b schematically illustrates a cross sectional view of a portion of crankpin.

Fig. 2 schematically illustrates kinematics of grinding of a workpiece, such as a crankpin.

Figs. 3a and 3b schematically illustrate a two-dimensional view of crankpin-grinding geometry.

Fig. 4 illustrates a first exemplifying embodiment of a method for determining grinding parameters according to the invention.

Fig. 5 illustrates a second exemplifying embodiment of a method for determining grinding parameters according to the invention.

Fig. 6 schematically illustrates a device comprising a computer programme according to an embodiment.

Detailed description

[0029] In the following, the invention will be described in more detail with reference to the drawings. However, the invention is not limited to the embodiments disclosed and discussed but may be varied within the scope of the appended claims. Furthermore, the drawings shall not be considered drawn to scale as some features may be exaggerated in order to more clearly illustrate the features.

[0030] Furthermore, the workpiece is in the following sometimes exemplified by a crankpin. The workpiece and the grinding method is however not limited to grinding of a crankpin and the workpiece may be any workpiece having a cylindrical bearing surface, a radially extending sidewall and a curved transition portion having a radius and connecting the cylindrical bearing surface with the sidewall. Typically, the workpiece comprises two radially extending sidewalls extending outward from the cylindrical bearing surface and each connected to the cylindrical bearing surface by a curved transition portion.

[0031] The present disclosure relates to grinding of a workpiece by means of a grinding wheel. The workpiece comprises a cylindrical bearing surface arranged around a centre axis. At an axial end of the cylindrical bearing surface, the workpiece comprises a radially extending sidewall which extends radially outward from the cylindrical bearing surface around the whole circumference of the cylindrical bearing surface. The cylindrical bearing surface is connected to the sidewall by means of a surface constituting a curved transition portion having a radius. As previously disclosed, Figures 1 a and 1b illustrates an example of such a workpiece.

[0032] The grinding wheel is essentially rotationally symmetrical around a rotational axis thereof, and is rotated around said rotational axis. The rotational axis of the grinding wheel is essentially parallel to the centre axis of the cylindrical bearing surface. Therefore, the radially peripheral surface of the grinding wheel will grind the cylindrical bearing surface whereas the axial peripheral surface of the grinding wheel will grind the sidewall of the workpiece. The grinding wheel

has a width, i.e. axial extension, which is smaller than the axial extension of the cylindrical bearing surface.

[0033] The present invention is based on an in-depth investigation to understand the complex mechanisms that arise at the interface between the grinding wheel and the workpiece at the cylindrical bearing surface, the sidewall and the curved transition portion connecting the cylindrical bearing surface with the sidewall, in terms of fundamental grinding parameters. These fundamental grinding parameters are: contact length between the workpiece and the grinding wheel (l_c), specific material removal rate (Q'_w), aggressiveness number ($aggr$), grinding power (P_g), and maximum surface temperature of the workpiece (θ_m). Based on the modelling, a strategy of the grinding method has been developed. The strategy is provided to achieve an essentially constant-temperature process that yields the shortest cycle time that can be achieved within temperature thresholds to avoid thermal damages of the workpiece.

[0034] The temperature limit to avoid thermal damage, of the workpiece depends on the material of the workpiece and the heat treatment process. The temperature limits may be determined via measured Barkhausen noise signals, measured residual stress values versus depth into the material, thermal softening from hardness measurements versus depth into the material, and rehardening burn by sectioning and examining for "white layer" (consisting of untempered martensite and retained austenite, resulting from phase transformations in the material of the workpiece) in order to "calibrate" Barkhausen noise signals to determine the thresholds for grinding without thermally damaging the workpiece. Then, these Barkhausen noise threshold values may be correlated with the simulated temperatures by the model, which will be further disclosed below, to determine processing parameters for grinding needed to avoid risk for thermal damage of the workpiece.

[0035] It has been found that an optimal strategy for the grinding method is a unique version of angle-plunge grinding (also known as vector grinding), utilizing the inherently better approach of angle-plunge grinding, and avoiding the problem of selecting inputs based on trial-and-error. However, the model developed may also be used if utilising other strategies for grinding, for example grinding methods utilising radial plunge followed by axial plunge.

[0036] The model developed in accordance with the present invention may be embedded into a simulation tool, i.e. a computer programme for determining processing parameters, that is used to visualize the fundamental grinding parameters, i.e. contact length between the workpiece and the grinding wheel, specific material removal rate, aggressiveness number, grinding power and maximum surface temperature at all points on the grinding wheel profile for a selected grinding increment.

[0037] During grinding of a workpiece, such as a workpiece as previously described, the instantaneous specific material removal rate, the aggressiveness number and specific energy (i.e. the energy per unit volume of material removal) change not only along the contact length from the cylindrical bearing surface, through the curved transition portion and up the sidewall, but the actual instantaneous contact length changes throughout the process as well. In addition, what the grinding wheel "sees" changes due to the changing three-dimensional surface along the radius of the curved transition portion and through the arc of contact. This complex geometry has not previously been modelled and analysed, and trying to analyse all three portions (the cylindrical bearing surface, the curved transition portion and the sidewall) can prove very difficult as the conditions change drastically just a short distance between points of the grinding wheel surface in contact with the workpiece.

[0038] In order to overcome these difficulties, an analytical approach has been taken to model the geometry and kinematics of the instantaneous grinding situation, taking every point of the grinding wheel surface individually and considering it as a separate entity from adjacent points on the grinding wheel surface. In this way, the fundamental grinding parameters in terms of contact length, specific material removal rate, aggressiveness number, grinding power and maximum surface temperature can be explicitly determined at each point without making assumptions. Based on such an approach, the grinding parameters for the whole grinding cycle can be optimised based on the most critical point of the grinding wheel at each moment, i.e. the point of the grinding wheel which at a specific condition and point of time would cause the highest risk for thermal damage of the workpiece.

[0039] Figure 2 schematically illustrates how the relative workpiece velocity, v_w , which constitutes the fundamental kinematical grinding parameter needed for modelling, is derived. More specifically, Figure 2 schematically illustrates a generalised case of workpiece grinding kinematics, where the workpiece angular speed, ω , is modelled around the workpiece (i.e. it is here assumed for the sake of modelling that the wheel moves around the workpiece), and thus illustrates a geometrical and kinematical framework for a functional determination of the relative workpiece velocity, v_w . The workpiece may for example be a crankpin 2 as shown in Figures 1 a and 1b and for sake of clarity the workpiece will in the following be exemplified by such a crankpin 2 of a crankshaft.

[0040] As shown in Figure 2, the workpiece has a radius, r_w , from a central axis 3b of the cylindrical bearing surface 3 to the peripheral surface thereof 3a, and the grinding wheel 6 has a radius, r_s , from its rotational centre 6b to the peripheral surface 6a thereof. The crankshaft 1 comprising the crankpin 2 has a rotational axis A. Thus, there is a distance $d_{ws}(\varphi_{ws})$ between the rotational axis A of the crankshaft and the rotational axis 6b of the grinding wheel, wherein the angle φ_{ws} constitutes the independent variable used. The eccentricity of the crankpin relative to the rotational axis A is denominated ecc_w .

[0041] For a modelling purpose, considering a fixed crankshaft, the kinematics of the grinding wheel relatively to the

fixed crankshaft is a combination of the grinding wheel rotation and the wheel translation. The vector $d_{ws}(\varphi_{ws})\omega(\varphi_{ws})$ has a direction perpendicular to the line between rotational axis A and rotational axis 6b, and the magnitude is known due to the known rotational speed of crankshaft in real application. The vector $v_{fa}(\varphi_{ws})$ has a direction parallel to the line between the rotational axis A and rotational axis 6b. The direction of vector $v_{ws}(\varphi_{ws})$ (sum of vectors $d_{ws}(\varphi_{ws})\omega(\varphi_{ws})$ and $v_{fa}(\varphi_{ws})$) is known, since the grinding wheel rotates around the crankpin, as is perpendicular to the line between central axis 3b and rotational axis 6b.

[0042] Based on the known magnitude and direction of the $d_{ws}(\varphi_{ws})\omega(\varphi_{ws})$ vector, as well as the directions of $v_{ws}(\varphi_{ws})$ and $v_{fa}(\varphi_{ws})$ vectors, magnitudes of $v_{ws}(\varphi_{ws})$ and $v_{fa}(\varphi_{ws})$ vectors are determined. Thus, based on the relations shown in Figure 2 the relative workpiece velocity, v_w , can be calculated in accordance with Eq. 1 below.

$$v_w(\varphi_{ws}) = \left[1 + \frac{ecc_w \cos \varphi_{ws}}{\sqrt{(r_s+r_w)^2 - (ecc_w \sin \varphi_{ws})^2}} \right] r_w \omega(\varphi_{ws}) \quad (\text{Eq. 1})$$

[0043] The relative workpiece velocity v_w as given above takes into account a possibility of the angular speed of the workpiece changing during the grinding cycle. However, in case the angular speed of the workpiece is not variable, or where it is purposively selected to be constant, only the average workpiece velocity needs to be taken into account. The average relative workpiece velocity may be calculated in accordance with Eq. 2.

$$v_w = r_{bs} \omega \quad (\text{Eq. 2})$$

where the general workpiece radius, r_w , is substituted with the radius, r_{bs} , of the cylindrical bearing surface 3 of the crankpin.

[0044] Figures 3a and 3b illustrate the basic geometry of crankpin grinding. As shown in the figures, the grinding wheel 6 has an axial extension b_s , i.e. a width, a radius r_s from the rotational axis to the radial peripheral surface 6a, and comprises a curved transition portion 6c between the peripheral radial and the peripheral axial surface of the grinding wheel. The curved transition portion 6c of the grinding wheel has a radius r_0 , which suitably may correspond to the intended radius of the curved transition portion 5 of the workpiece. As shown in Figure 3a, the cylindrical bearing surface 3 has a radius, r_{bs} , when the intended total stock to be removed in radial direction $\delta_{x,tot}$ has been removed. The total stock to be removed at the sidewall 4, i.e. axial direction, of the workpiece is illustrated by $\delta_{z,tot}$. The sidewall 4 extends radially outward from the cylindrical bearing surface such that the radial peripheral surface of the sidewall has a radius r_{sw} , i.e. the sidewall is formed of a cylindrical portion having the radius r_{sw} .

[0045] Grinding may be performed by different feeds in z-direction (axial direction) and x-direction (radial direction) of the workpiece as previously discussed. As shown in Figures 3a and 3b, the grinding wheel may be moved an axial distance $a_{z,i}$ into the workpiece, and a radial distance $a_{x,i}$ (radial depth) into the workpiece, with i being the iteration number of workpiece revolutions, i.e. the number of the grinding increment. Although from the two dimensional perspective shown in figures 3a and 3b the sidewall may be seen as a flat surface, the grinding wheel creates an arc on the workpiece.

[0046] In each increment, the contact between the grinding wheel and the workpiece is in reality a three-dimensional surface. A surface can be geometrically described using two parameters. In the present case, the parameter "s" is used and represents an arc length on the wheel profile with the origin at the beginning of the radius and is in a cross sectional plane. The parameter "s" is in the model used as an independent variable in the grinding model, as will be further described below. The second parameter for describing the surface of contact between the grinding wheel and the workpiece may for example be the angle in circumferential direction of the grinding wheel. However, by applying fundamental grinding modelling approach in every point, s, variations in circumferential direction may be avoided.

[0047] Based on the basic geometry, when the grinding wheel is in contact with the workpiece, each point s on the grinding wheel profile (i.e. peripheral surface of the grinding wheel) in a cross sectional plane through the grinding wheel axis and the workpiece axis may be analysed with respect to the grinding wheel profile arc length starting from the cylindrical bearing surface (negative values), moving up the radius r_0 (positive values, from the perspective of the wheel) and then up the sidewall of the grinding wheel, i.e. the axial peripheral surface of the grinding wheel. At every grinding increment, the contact portion of the grinding wheel profile can be determined by a lower limit, $s_{0,i}$ and an upper limit, $s_{1,i}$, depending on the wheel position, given by distances $d_{z,i}$ and $d_{x,i}$, and feeds $a_{z,i}$ and $a_{x,i}$.

[0048] A robust model for the grinding process of a crankpin (or grinding of any other workpiece comprising a cylindrical bearing surface, sidewalls and curved transition portions as disclosed above) may be developed by substituting the actual, inherently complex, three-dimensional geometrical scenario along the wheel profile with an equivalent plane-surface-grinding scenario at every point of the profile, s, in terms of fundamental grinding parameters. Said model may then be used for process planning, i.e. design of a grinding cycle in terms of feeds for the grinding increments, and for

EP 3 115 149 B1

simultaneous process optimisation, i.e. minimising the grinding cycle time.

[0049] In accordance with the present invention, modelling of the grinding geometry is performed by determination of simplified relations between axial and radial feeds (a_z, a_x), corresponding depth of cut, a_e , and contact length, l_c , at the cylindrical bearing surface (Eq. 3 and Eq. 4), the curved transition portion (Eq. 5 and Eq. 6) and the sidewall of the workpiece (Eq. 7 and Eq. 8). More specifically:

- At cylindrical bearing surface; $s \leq 0$:

$$a_e(s) = a_x \quad (\text{Eq. 3})$$

$$l_c(s) = \sqrt{2r_{eq}a_e(s)}. \quad (\text{Eq. 4})$$

- At curved transition portion of workpiece; $0 < s < \frac{\pi}{2}r_0$:

$$a_e(s) = a_x \cos \frac{s}{r_0} + a_z \sin \frac{s}{r_0} \quad (\text{Eq. 5})$$

$$l_c(s) = \sqrt{\frac{2r_{eq}r_0}{\sin^4 \frac{s}{r_0}} \left[\sqrt{\cos^2 \frac{s}{r_0} + 2 \frac{a_e(s)}{r_0} \sin^4 \frac{s}{r_0} - \cos \frac{s}{r_0}} \right]} \quad (\text{Eq. 6})$$

- At sidewall of workpiece; $s \geq \frac{\pi}{2}r_0$:

$$a_e(s) = a_z \quad (\text{Eq. 7})$$

$$l_c(s) = \sqrt{2r_{eq} \left[s - \frac{\pi}{2}r_0 + \sqrt{2r_0 a_e(s)} \right]} \quad (\text{Eq. 8})$$

[0050] In the equations above, r_{eq} , is the equivalent radius and is defined by Eq. 9.

$$r_{eq} = \frac{r_s r_w}{r_s + r_w} \quad (\text{Eq. 9})$$

[0051] Based on the modelling approach described above, the fundamental grinding parameters specific material removal rate Q'_w , aggressiveness number $aggr$, grinding power P_g and maximum surface temperature θ_m can be calculated as given below by Eq. 10 to Eq. 13 in every point s of the grinding wheel profile.

$$Q'_w(s) = v_w a_e(s) \quad (\text{Eq. 10})$$

$$aggr(s) = \frac{10^6 Q'_w(s)}{v_s l_c(s)} \quad (\text{Eq. 11})$$

$$P_g = \int_{s_0}^{s_1} e_{tot}[aggr(s)] Q'_w(s) ds \quad (\text{Eq. 12})$$

$$\theta_m(s) = \frac{1.064}{\sqrt{k\rho c_p}} e_w[aggr(s)] \frac{Q'_w(s)}{\sqrt{l_c(s)v_w}} \quad (\text{Eq. 13})$$

[0052] In Eq. 11, v_s is the grinding wheel speed. In Eq. 13, k is the thermal conductivity, p the density, and c_p the specific heat of the workpiece material.

[0053] A core part of thermal modelling is the determination of the specific energy into the workpiece characteristic (versus aggressiveness number), $e_w(aggr)$, which is based on the total specific energy characteristic, $e_{tot}(aggr)$, and the thermal model.

[0054] The total specific energy characteristic, $e_{tot}(aggr)$, may be obtained from grinding experiments, where grinding power is measured for various feeds. The experiments may suitably be conducted in two separate stages, i) sidewall grinding where only axial feed is used and ii) cylindrical bearing surface grinding where only radial feed is used. The total specific energy characteristic is given below with reference from Eq. 14 to Eq. 18.

- Low aggressiveness - side wall grinding; $aggr \leq aggr_{0z}$:

$$aggr_{0z} = \left[(2\mu_z - 1) \frac{C_z}{e_{0z}} \right]^{\frac{1}{\mu_z}}, \quad (\text{Eq. 14})$$

$$e_{tot}(aggr) = e_{0z} + \frac{C_z}{aggr^{\mu_z}}, \quad (\text{Eq. 15})$$

where $aggr_{0z}$ is the optimal aggressiveness for sidewall grinding.

- High aggressiveness - cylindrical bearing surface grinding; $aggr \geq aggr_{0x}$:

$$aggr_{0x} = \left[(2\mu_x - 1) \frac{C_x}{e_{0x}} \right]^{\frac{1}{\mu_x}}, \quad (\text{Eq. 16})$$

$$e_{tot}(aggr) = e_{0x} + \frac{C_x}{aggr^{\mu_x}}, \quad (\text{Eq. 17})$$

where $aggr_{0x}$ is the optimal aggressiveness for bearing-surface grinding.

- Transition region; $aggr_{0z} < aggr < aggr_{0x}$:

Based on exponential interpolation:

$$e_{tot}(aggr) = e_{tot}(aggr_{0z}) e^{c_1(aggr - aggr_{0z}) + c_2(aggr - aggr_{0z})^2 + c_3(aggr - aggr_{0z})^3} \quad (\text{Eq. 18})$$

[0055] The coefficients c_1, c_2 and c_3 are determined in order to get continuous and smooth total specific energy characteristic.

[0056] Constants of the characteristic e_{0z}, C_z, e_{0x}, C_x are obtained with approximation of the measured results by the least-square method, while the exponents in the expressions are chosen as: $\mu_z = 1$ and $\mu_x = 3/2$, in order to get a finite value when the depth of cut approaches zero value.

[0057] The specific energy into the workpiece characteristic, $e_w(aggr)$, is then determined by calculating energy partition ratios, ε_z and ε_x , for each grinding type separately. Calculations are based on the use of the thermal model combined with the measured Barkhausen noise signals, which are correlated with certain maximum surface temperature values. In this way, the specific energy into the workpiece characteristic is obtained based on the total specific energy characteristic as given below with reference from Eq. 19 to Eq.21.

- Low aggressiveness - side wall grinding; $aggr \leq aggr_{0z}$:

$$e_w(aggr) = \varepsilon_z \left(e_{0z} + \frac{C_z}{aggr^{\mu_z}} \right) = e_{w0z} + \frac{C_{wz}}{aggr^{\mu_z}}, \quad (\text{Eq. 19})$$

- High aggressiveness - cylindrical bearing surface grinding; $aggr \geq aggr_{0x}$:

$$e_w(aggr) = \varepsilon_x \left(e_{0x} + \frac{c_x}{aggr \mu_x} \right) = e_{w0x} + \frac{c_{wx}}{aggr \mu_x}, \quad (\text{Eq. 20})$$

- 5 • Transition region; $aggr_{0z} < aggr < aggr_{0x}$:

Based on continuous and smooth exponential interpolation:

$$10 \quad e_w(aggr) = e_w(aggr_{0z}) e^{c_{w1}(aggr-aggr_{0z})+c_{w2}(aggr-aggr_{0z})^2+c_{w3}(aggr-aggr_{0z})^3} \quad (\text{Eq. 21})$$

15 **[0058]** By using the model as described above, grinding of a workpiece comprising a cylindrical bearing surface, a radial sidewall and a curved transition portion connecting the cylindrical bearing surface with the sidewall can be optimised as disclosed below. The grinding method is optimised by determining axial and radial feeds (a_z and a_x) within each increment, necessary to grind the workpiece at a set maximum surface temperature, thereby also obtaining the number of increments needed (which inherently also is the lowest possible for the grinding cycle). The lowest number of grinding increments gives the minimum grinding cycle time. By controlling the method so that the set maximum surface temperature is not exceeded at any point on the contact between the workpiece and the grinding wheel, there is no risk for thermal damage of the workpiece during grinding.

20 **[0059]** Based on the above, a method for determining grinding parameters may be achieved. Thus, the present invention provides a method of determining processing parameters of a grinding method for grinding a workpiece by means of an essentially rotational symmetrical grinding wheel, the workpiece comprising a cylindrical bearing surface 3, a radially extending sidewall 4 extending outward from the cylindrical bearing surface, and a curved transition portion 5 connecting the cylindrical bearing surface with the sidewall, wherein the grinding wheel has an axial extension less than the axial extension of the cylindrical bearing surface, the method comprising, based on a pre-set maximum surface temperature, determining a number of increments and the respective axial feed and radial feed of said increments. The method comprises the following steps:

- 30 a) based on a position of the grinding wheel at the end of the grinding cycle, determining the distance into the workpiece in radial respectively axial direction and hence determine the corresponding contact portion set by a lower limit and an upper limit (of the grinding wheel profile);
- b) determining an axial feed and a radial feed, in a corresponding increment, necessary to keep the pre-set maximum surface temperature at a point of the contact portion of the grinding wheel resulting in a highest surface temperature of the workpiece during said corresponding increment;
- 35 c) based on the axial feed and the radial feed determined in step b) determining the resulting grinding wheel position after completion of one increment with said axial feed and radial feed,
- d) based on the grinding wheel position obtained in step c) determining a corresponding contact portion with a corresponding lower limit and upper limit of the grinding wheel profile;
- e) in case the lower limit of the contact portion is less than the upper limit of the contact portion obtained in step d) repeating steps b) to d) until the lower contact limit of the contact portion is not less than the upper limit;
- 40 f) indexing the obtained increments and their respective axial feed and radial feed according to the grinding process.

[0060] Figure 4 illustrates a first exemplifying embodiment of such a method for determining grinding parameters. The method comprises, based on system and thermal inputs 400, determining the outputs 406 constituting the number of increments, n , and the axial feed $a_{z,i}$ and radial feed $a_{x,i}$ in each of the increments, $i = 1, 2 \dots n$.

[0061] In accordance with the method, the calculation of feeds starts at the final wheel position, i.e. when $d_z = \delta_{z,tot}$ and $d_x = r_{sw} - r_{bs} + \delta_{x,tot}$ and moves backwards to the initial position of the grinding wheel just before the beginning of grinding. Both total grinding allowances, $\delta_{z,tot}$ and $\delta_{x,tot}$ may include a certain offset needed to compensate for a possible run-out in the incoming workpiece dimensions.

50 **[0062]** Thus, based on the wheel position at end of grinding and the corresponding distance into the workpiece as defined by $d_{z,j}$ and $d_{x,j}$ the corresponding contact portion set by a lower limit $s_{0,j}$ and an upper limit $s_{1,j}$ of the grinding wheel is determined, 401.

[0063] The central part of the method is a constant-temperature process, where the axial feed, $a_{z,j}$ and radial feed, $a_{x,j}$ needed to keep the pre-set maximum surface temperature at a point of the contact portion of the grinding wheel resulting in a highest surface temperature of the workpiece, while achieving maximum material removal rate, $Q_{w,j}$ during such an increment, is determined, 402.

[0064] First, the limit depth of cut, a_{e^*} , is calculated as a function of wheel profile position, s , in order to match the

pre-set maximum surface temperature, θ^* . For this purpose, the thermal model is written in the following form (Eq. 22):

$$\theta^* = \frac{1.064}{\sqrt{k\rho c_p}} e_w [aggr(s, a_e^*)] \sqrt{\frac{v_s}{10^6} a_e^* aggr(s, a_e^*)} \Rightarrow a_e^* = a_e^*(s, \theta^*) \quad (\text{Eq. 22})$$

which includes grinding parameters as functions of both wheel profile position and limit depth of cut.

[0065] That is, the limit depth of cut a_e^* is calculated in every point s of the wheel profile, regardless of a grinding increment j and contact portion limits $s_{0,j}$ and $s_{1,j}$. This means that $a_e^*(s, \theta^*)$ is only one function for all increments and can be calculated in advance for given pre-set temperature θ^* . In other words, function $a_e^*(s, \theta^*)$ represents the pre-set temperature (which has the same value for all points s) translated into the limit depth of cut (which is, because of changing geometry, a different value in every point s).

[0066] Next, the algorithm determines the axial feed, $a_{z,j}$, and radial feed, $a_{x,j}$, in a way that:

- the pre-set maximum surface temperature is not exceeded in the wheel-profile contact portion, which in terms of depth-of-cut reads in accordance with Eq. 23:

$$a_{e,j}(s) \leq a_e^*(s, \theta^*) \quad (\text{Eq. 23})$$

- maximum material removal rate, which is calculated in accordance with Eq. 24:

$$Q_{w,j} = \int_{s_{0,j}}^{s_{1,j}} Q'_{w,j}(s) ds = v_w \int_{s_{0,j}}^{s_{1,j}} a_{e,j}(s) ds \quad (\text{Eq. 24})$$

is achieved in the current grinding increment, j .

[0067] If the limit depth of cut function would be used in every point s , the pre-set maximum surface temperature would be achieved at every point s . However, only the feeds $a_{z,j}$ and $a_{x,j}$ are used in order to adjust in a current increment. This means that the pre-set temperature can only be achieved in two points s of the contact portion in the current increment. Therefore, two critical points of the limit depth of cut function should be selected in the current contact interval. In other words, the values of $a_{z,j}$ and $a_{x,j}$ are to be determined in such a way as to match the pre-set maximum surface temperature θ^* only in two points of the contact interval ($s_{cr1,j}$ and $s_{cr2,j}$). Everywhere else the actual depth of cut is lower than the limit depth of cut in those points, since the critical two values of a_e^* is used for calculation of $a_{z,j}$ and $a_{x,j}$, and hence the surface temperature of the workpiece will be lower than the pre-set maximum surface temperature.

[0068] Thus, in accordance with the present invention the algorithm then choses two critical points of the calculated limit-depth-of-cut function in the current grinding increment. Candidates for those two points are the ones in the current contact interval that simultaneously fulfil the conditions given by Eq. 23 and Eq. 24. The two critical points are further used to determine the corresponding axial and radial feeds as:

$$a_{z,j} = \frac{-a_{cr1,j}^* \cos \frac{s_{cr2,j}}{r_0} + a_{cr2,j}^* \cos \frac{s_{cr1,j}}{r_0}}{\sin \left(\frac{s_{cr2,j} - s_{cr1,j}}{r_0} \right)} \quad (\text{Eq. 25})$$

$$a_{x,j} = \frac{a_{cr1,j}^* \sin \frac{s_{cr2,j}}{r_0} - a_{cr2,j}^* \sin \frac{s_{cr1,j}}{r_0}}{\sin \left(\frac{s_{cr2,j} - s_{cr1,j}}{r_0} \right)} \quad (\text{Eq. 26})$$

where $a_{cr1,j}^* = a_e^*(s_{cr1,j}, \theta^*)$ and $a_{cr2,j}^* = a_e^*(s_{cr2,j}, \theta^*)$.

[0069] Next, the new wheel position is determined by reducing for the calculated feeds, and hence the new wheel-profile contact limits are determined, 403.

[0070] The algorithm continues with the calculations until there is no contact between the wheel and the crankpin,

404. In the final stage, the number of grinding increments is determined and the calculated feeds are indexed according to the grinding process, 405.

[0071] Figure 5 illustrates a second exemplifying embodiment of a method for determining grinding parameters. The second exemplifying embodiment corresponds to the exemplifying embodiment as shown in Figure 4 except that it provides the possibility to set two input surface temperatures, θ_1^* and θ_2^* , 500. The first set temperature, θ_1^* , can be higher than θ_2^* in order to have an additional possibility to even further reduce the grinding cycle time, because it is used to control the first grinding portion, which is related to the defined amount of axial grinding allowance, $\delta_{z,1}$. In this first grinding portion, the process planner has the possibility to set a higher θ_1^* to induce slight thermal damage into the workpiece (e.g. slight tensile residual stresses) in a controlled way if grinding cycle time is crucial. Then, in the second grinding portion, which is the final one, the remaining allowance, i.e. $\delta_{z,tot} - \delta_{z,1}$, is ground with a lower set temperature θ_2^* to improve quality (surface integrity) of the ground workpiece surface without any thermal damage. When choosing a high θ_1^* , the process planner needs to be careful that the depth of eventual thermal damage into the workpiece is lower than the remaining allowance $\delta_{z,tot} - \delta_{z,1}$.

[0072] The grinding method is not limited to the specific embodiments described above but may be varied within the scope of the appended claims. For example, grinding may be performed with a constant or non-constant rotational speed of the workpiece during each increment. Furthermore, the rotational speed of the workpiece in one increment may be different from a rotational speed of the workpiece in a subsequent increment if desired. Moreover, the grinding method may for example be an angle-plunge grinding method, or a combined radial and axial plunge grinding method wherein for the majority of the process the grinding wheel is plunged radially into the workpiece. Other types of grinding processes are also feasible.

[0073] Furthermore, the grinding method as disclosed herein can be used on a conventional grinding machine or apparatus used for the same purpose and is not limited to certain grinding machines or the like.

[0074] Figure 6 is a diagram of an exemplified device 600. An electronic control unit of a grinding machine may for example comprise the exemplified device 600 or the device may be a separate unit from the grinding machine. The device 600 comprises a non-volatile memory 620, a data processing unit 610 and a read/write memory 650. The non-volatile memory 620 has a first memory element 630 in which a computer programme, e.g. an operating system, is stored for controlling the function of the device 600. The device 600 may further comprise a bus controller, a serial communication port, I/O means, an A/D converter, a time and date input and transfer unit, an event counter and an interruption controller (not depicted). The non-volatile memory 620 has also a second memory element 640.

[0075] There is a computer programme P provided which comprises routines for determining processing parameters, more specifically number of increments and feed in each of the increments, of a grinding method for grinding a workpiece by means of an essentially rotational symmetrical grinding wheel, wherein the processing parameters are determined by:

- a) based on a position of the grinding wheel at the end of the grinding cycle, determining the distance into the workpiece in radial respectively axial direction and hence determine the corresponding contact portion set by a lower limit and an upper limit (of the grinding wheel profile;
- b) determining an axial feed and a radial feed, in a corresponding increment, necessary to keep the pre-set maximum surface temperature at a point of the contact portion of the grinding wheel resulting in a highest surface temperature of the workpiece during said corresponding increment;
- c) based on the axial feed and the radial feed determined in step b) determining the resulting grinding wheel position after completion of one increment with said axial feed and radial feed,
- d) based on the grinding wheel position obtained in step c) determining a corresponding contact portion with a corresponding lower limit and upper limit of the grinding wheel profile;
- e) in case the lower limit of the contact portion is less than the upper limit of the contact portion obtained in step d) repeating steps b) to d) until the lower contact limit of the contact portion is not less than the upper limit;
- f) indexing the obtained increments and their respective axial feed and radial feed according to the grinding process.

[0076] The computer programme may further be arranged to provide the determined processing parameters to an electronic control unit or another computer connected to or adapted to communicate with the electronic control unit.

[0077] The computer programme may be stored in an executable form in a compressed form in a memory 660 and/or in a read/write memory 650.

[0078] Where the data processing unit 610 is described as performing a certain function, it means that the data processing unit 610 effects a certain part of the programme stored in the memory 660, or a certain part of the programme stored in the read/write memory 650.

[0079] The data processing device 610 can communicate with a data port 699 via a data bus 615. The non-volatile

memory 620 is intended for communication with the data processing unit 610 via a data bus 612. The separate memory 660 is intended to communicate with the data processing unit 610 via a data bus 611. The read/write memory 650 is adapted to communicate with the data processing unit 610 via a data bus 614.

[0080] When data are received on the data port 699, they are stored temporarily in the second memory element 640. When input data received have been temporarily stored, the data processing unit 610 is prepared to effect code execution as described above.

[0081] Parts of the methods herein described may be affected by the device 600 by means of the data processing unit 610 which runs the programme stored in the memory 660 or the read/write memory 650. When the device 600 runs the programme, methods herein described are executed.

[0082] The foregoing description of the exemplified embodiments of the present invention is provided for illustrative and descriptive purposes. It is not intended to be exhaustive or to restrict the invention to the variants described. Many modifications and variations will obviously be apparent to one skilled in the art. The embodiments have been chosen and described in order best to explain the principles of the invention and its practical applications and hence make it possible for specialists to understand the invention for various embodiments and with the various modifications appropriate to the intended use.

Claims

1. Method of grinding a workpiece by means of an essentially rotational symmetrical grinding wheel (6), the workpiece comprising a cylindrical bearing surface (3), a radially extending sidewall (4) extending outward from the cylindrical bearing surface, and a curved transition portion (5) connecting the cylindrical bearing surface with the sidewall, wherein the grinding wheel has an axial extension less than the axial extension of the cylindrical bearing surface, the method comprising grinding the workpiece in a plurality of grinding increments together defining a grinding cycle, each grinding increment performed with a respective feed of the grinding wheel in relation to the workpiece, **characterised in that**, in each grinding increment, the feed is selected so as to achieve a pre-set maximum surface temperature of the workpiece at a point of the grinding wheel resulting in the highest surface temperature of the workpiece.
2. Method according to claim 1, wherein the feed comprises an axial feed and a radial feed, and the axial feed and the radial feed are independently selected so as to achieve said pre-set maximum surface temperature of the workpiece at the contact point of the grinding wheel resulting in the highest surface temperature of the workpiece.
3. Method according to any of the preceding claims, wherein the grinding wheel is rotated with a constant rotational speed throughout the grinding cycle.
4. Method according to any of the preceding claims, wherein the workpiece is rotated with a constant rotational speed throughout the grinding cycle.
5. Method according to any of the preceding claims, wherein the workpiece is a crankpin (2) of a crankshaft (1).
6. Method of determining processing parameters of a grinding method for grinding a workpiece by means of an essentially rotational symmetrical grinding wheel (6) having a grinding wheel profile, the workpiece comprising a cylindrical bearing surface (3), a radially extending sidewall (4) extending outward from the cylindrical bearing surface, and a curved transition portion (5) connecting the cylindrical bearing surface with the sidewall, wherein the grinding wheel has an axial extension less than the axial extension of the cylindrical bearing surface, the method comprising based on a pre-set maximum surface temperature (θ^*) determining a number of increments (n) and the respective axial feed ($a_{z,i}$) and radial feed ($a_{x,i}$) of said increments, the method comprising the following steps:
 - a) based on a position of the grinding wheel at the end of the grinding cycle, determining the distance ($d_{z,j}$, $d_{x,j}$) into the workpiece in radial respectively axial direction and hence determine the corresponding contact portion set by a lower limit ($s_{0,j}$) and an upper limit ($s_{1,j}$) of the grinding wheel profile (401);
 - b) determining an axial feed ($a_{z,j}$) and a radial feed ($a_{x,j}$), in a corresponding increment, necessary to keep the pre-set maximum surface temperature (θ^*) at a point of the contact portion of the grinding wheel resulting in a highest surface temperature of the workpiece (402) during said corresponding increment;
 - c) based on the axial feed ($a_{z,j}$) and the radial feed ($a_{x,j}$) determined in step b) determining the resulting grinding wheel position after completion of one increment with said axial feed and radial feed,
 - d) based on the grinding wheel position obtained in step c) determining a corresponding contact portion with a

corresponding lower limit and upper limit of the grinding wheel profile (403);

e) in case the lower limit of the contact portion is less than the upper limit of the contact portion obtained in step d) repeating steps b) to d) until the lower contact limit of the contact portion is not less than the upper limit (404);
 f) indexing the obtained increments (*i*) and their respective axial feed and radial feed according to the grinding process (405).

7. The method according to claim 6, wherein determining the axial feed ($a_{z,j}$) and a radial feed ($a_{x,j}$) necessary to keep the pre-set maximum surface temperature (θ^*) at a point of the contact portion of the grinding wheel resulting in a highest surface temperature of the workpiece in step b) is performed such as to achieve a maximum material removal rate in the corresponding increment.

8. The method according to any of claims 6 or 7, wherein the axial feed and radial feed are determined in step b) by calculating a limit depth of cut (a_e^*) as a function of the grinding wheel profile position (*s*) in order to match the pre-set maximum surface temperature (θ^*), selecting two critical points of the limit depth of cut function (s_{cr1} , s_{cr2}) in the current contact interval, and using the two critical points to determine the corresponding axial feed and radial feed.

9. The method according to claim 8, wherein the limit depth of cut function is given by the following equation (Eq.22)

$$\theta^* = \frac{1.064}{\sqrt{k\rho c_p}} e_w [aggr(s, a_e^*)] \sqrt{\frac{v_s}{10^6} a_e^* aggr(s, a_e^*)} \Rightarrow a_e^* = a_e^*(s, \theta^*) \quad (Eq. 22)$$

wherein θ^* is the pre-set maximum surface temperature, *k* is the thermal conductivity of the workpiece material, ρ the density of the workpiece material, c_p is the specific heat of the workpiece material, e_w is the specific energy into the workpiece, v_s is the grinding wheel speed, and *aggr* is the aggressiveness number.

10. Method according to claim 9, wherein the total specific energy characteristic, $e_{tot}(aggr)$, is obtained from grinding power measurements performed in a first step comprising only sidewall grinding wherein only axial feed is used, and a second step comprising only cylindrical bearing surface grinding wherein only radial feed is used, and wherein the total specific energy in the transition region is obtained by exponential interpolation; and wherein the specific energy into the workpiece characteristic $e_w(aggr)$ is determined by calculating energy partition ratios and applying them to the total specific energy characteristic for each grinding type separately, and wherein the specific energy in the transition region is again obtained by exponential interpolation.

11. Computer programme (P) for determining processing parameters of a grinding method, wherein said computer programme comprises programme code for performing the method steps of any of claims 6 to 10.

12. Computer programme according to claim 11, further arranged to provide said determined processing parameters to an electronic control unit or another computer connected to or adapted to communicate with the electronic control unit.

13. Computer programme product containing programme code stored on a computer-readable medium for performing the method according to any of claims 6 to 10, wherein said computer programme is run on an electronic control unit or another computer connected to or adapted to communicate with the electronic control unit.

Patentansprüche

1. Verfahren zum Schleifen eines Werkstücks mittels einer im Wesentlichen rotationssymmetrischen Schleifscheibe (6), wobei das Werkstück eine zylindrische Lagerfläche (3), eine sich radial erstreckende Seitenwand (4), die sich aus der zylindrischen Lagerfläche nach außen erstreckt, und einen gekrümmten Übergangsabschnitt (5) aufweist, der die zylindrische Lagerfläche mit der Seitenwand verbindet, wobei die Schleifscheibe eine axiale Erstreckung hat, die kleiner ist als die axiale Erstreckung der zylindrischen Lagerfläche, wobei das Verfahren das Schleifen des Werkstücks in einer Mehrzahl Schleifinkrementen, die zusammen einen Schleifzyklus definieren, aufweist, wobei jedes Schleifinkrement mit einem entsprechenden Vorschub der Schleifscheibe relativ zum Werkstück ausgeführt wird,

dadurch gekennzeichnet, dass in jedem Schleifinkrement der Vorschub so gewählt wird, dass eine voreingestellte

EP 3 115 149 B1

maximale Oberflächentemperatur des Werkstücks an einem Punkt der Schleifscheibe erzielt wird, die in der höchsten Oberflächentemperatur des Werkstücks resultiert.

2. Verfahren nach Anspruch 1, wobei der Vorschub einen axialen Vorschub und einen radialen Vorschub aufweist und der axiale Vorschub sowie der radiale Vorschub unabhängig gewählt werden, um die voreingestellte maximale Oberflächentemperatur des Werkstücks am Kontaktpunkt der Schleifscheibe zu erzielen, die in der höchsten Oberflächentemperatur des Werkstücks resultiert.
3. Verfahren nach einem der vorigen Ansprüche, wobei sich die Schleifscheibe während des gesamten Schleifzyklus mit einer konstanten Rotationsgeschwindigkeit dreht.
4. Verfahren nach einem der vorigen Ansprüche, wobei sich das Werkstück während des gesamten Schleifzyklus mit einer konstanten Rotationsgeschwindigkeit dreht.
5. Verfahren nach einem der vorigen Ansprüche, wobei das Werkstück ein Kurbelzapfen (2) einer Kurbelwelle (1) ist.
6. Verfahren zum Bestimmen von Bearbeitungsparametern eines Schleifverfahrens zum Schleifen eines Werkstücks mittels einer im Wesentlichen rotationssymmetrischen Schleifscheibe (6) mit einem Schleifscheibenprofil, wobei das Werkstück eine zylindrische Lagerfläche (3), eine sich aus der zylindrischen Lagerfläche radial nach außen erstreckende Seitenwand (4) und einen gekrümmten Übergangsabschnitt (5) aufweist, der die zylindrische Lagerfläche mit der Seitenwand verbindet, wobei die Schleifscheibe eine axiale Erstreckung hat, die kleiner ist als die axiale Erstreckung der zylindrischen Lagerfläche, wobei das Verfahren die Bestimmung einer Anzahl Inkremente (n) und des jeweiligen axialen Vorschubs ($a_{z,i}$) sowie des radialen Vorschubs ($a_{x,i}$) der Inkremente auf Basis einer voreingestellten maximalen Oberflächentemperatur (θ^*) aufweist, wobei das Verfahren die Schritte aufweist:
 - a) Bestimmen der Strecke ($d_{z,j}$), ($d_{x,j}$) in das Werkstück in radialer bzw. axialer Richtung und somit Bestimmen des durch einen unteren Grenzwert ($s_{0,j}$) und einen oberen Grenzwert ($s_{1,j}$) des Schleifscheibenprofils (401) eingestellten entsprechenden Kontaktabschnitts auf Basis einer Position der Schleifscheibe am Ende des Schleifzyklus;
 - b) Bestimmen eines axialen Vorschubs ($a_{z,i}$) und eines radialen Vorschubs ($a_{x,i}$) in einem entsprechenden Inkrement, die erforderlich sind, um die voreingestellte maximale Oberflächentemperatur (θ^*) an einem Punkt des Kontaktabschnitts der Schleifscheibe aufrechtzuerhalten, was in der höchsten Oberflächentemperatur des Werkstücks (402) während des entsprechenden Inkrements resultiert;
 - c) Bestimmen der resultierenden Schleifscheibenposition nach Beendigung eines Inkrements bei dem axialen Vorschub und dem radialen Vorschub auf Basis des in Schritt b) bestimmten axialen Vorschubs ($a_{z,i}$) und des radialen Vorschubs ($a_{x,i}$),
 - d) Bestimmen eines entsprechenden Kontaktabschnitts mit einem entsprechenden unteren Grenzwert und einem oberen Grenzwert des Schleifscheibenprofils auf Basis der in Schritt c) bestimmten Schleifscheibenposition (403);
 - e) Wiederholen der Schritte b) bis d), falls der untere Grenzwert des Kontaktabschnitts niedriger ist als der in Schritt d) erhaltene obere Grenzwert des Kontaktabschnitts, bis der untere Grenzwert des Kontaktabschnitts nicht mehr niedriger ist als der obere Grenzwert (404);
 - f) Indexieren der erhaltenen Inkremente (i) sowie ihres entsprechenden axialen Vorschubs und radialen Vorschubs gemäß dem Schleifprozess (405).
7. Verfahren nach Anspruch 6, wobei die Bestimmung des axialen Vorschubs ($a_{z,i}$) und des radialen Vorschubs ($a_{x,i}$), die erforderlich sind, um die voreingestellte maximale Oberflächentemperatur (θ^*) an einem Punkt des Kontaktabschnitts der Schleifscheibe aufrechtzuerhalten, die in der höchsten Oberflächentemperatur des Werkstücks in Schritt b) so erfolgt, dass eine maximale Materialabtragungsgeschwindigkeit im entsprechenden Inkrement erzielt wird.
8. Verfahren nach einen der Ansprüche 6 oder 7, wobei der axiale Vorschub und der radiale Vorschub durch Berechnung einer Begrenzung der Schnitttiefe (a_e^*) als eine Funktion der Schleifscheibenprofilposition (s) in Schritt b), um die voreingestellte maximale Oberflächentemperatur (θ^*) anzupassen, durch Wählen zweier kritischer Punkte der Schnitttiefenbegrenzungsfunktion (s_{cr1} , s_{cr2}) im aktuellen Kontaktintervall und durch Verwenden der zwei kritischen Punkte zur Bestimmung des entsprechenden axialen und radialen Vorschubs bestimmt werden.
9. Verfahren nach Anspruch 8, wobei die Schnitttiefenbegrenzungsfunktion durch die folgende Gleichung gegeben

ist: (Gleichung 22)

$$\theta^* = \frac{1.064}{\sqrt{k\rho c_p}} e_w [aggr(s, a_e^*)] \sqrt{\frac{v_s}{10^4} a_e^* aggr(s, a_e^*)} \Rightarrow a_e^* = a_e^*(s, \theta^*)$$

(Gl. 22)

dabei ist (θ^*) die voreingestellte maximale Oberflächentemperatur, k ist die Wärmeleitfähigkeit des Werkstückmaterials, ρ die Dichte des Werkstückmaterials, c_p ist die spezifische Wärme des Werkstückmaterials, e_w ist die spezifische Energie die in das Werkstückmaterial eingebracht wird, v_s ist die Schleifscheibengeschwindigkeit und $aggr$ ist die Aggressivitätszahl.

10. Verfahren nach Anspruch 9, wobei der spezifische Gesamtenergiekennwert $e_{tot}(aggr)$ aus den Schleifkraftmessungen erhalten wird, die in einem ersten Schritt, bei dem nur Seitenwandschleifen mit nur axialem Vorschub angewendet wird, und in einem zweiten Schritt, in dem nur Schleifen der zylindrischen Lagerfläche mit nur radialem Vorschub angewendet wird, ausgeführt werden, und wobei die spezifische Gesamtenergie im Übergangsbereich durch exponentielle Interpolation erhalten wird; und wobei die in den Werkstückkennwert $e_w(aggr)$ eingegangene spezifische Energie durch Berechnen und Anwenden von Energieverteilungsverhältnissen auf den spezifischen Gesamtenergiekennwert für jeden Schleiftyp getrennt bestimmt wird, und wobei die spezifische Energie im Übergangsbereich wieder durch exponentielle Interpolation erhalten wird.
11. Computerprogramm (P) zur Bestimmung von Bearbeitungsparametern eines Schleifverfahrens, wobei das Computerprogramm einen Programmcode zum Ausführen der Verfahrensschritte nach einem der Ansprüche 6 bis 10 aufweist.
12. Computerprogramm (P) nach Anspruch 11, das ferner zur Bereitstellung der bestimmten Bearbeitungsparameter an eine elektronische Steuereinheit oder an einen anderen zur Kommunikation mit der elektronischen Steuereinheit an die elektronische Steuereinheit angeschlossenen Computer konfiguriert ist, um mit der elektronischen Steuereinheit zu kommunizieren.
13. Computerprogrammprodukt mit einem Programmcode, der auf einem computerlesbaren Medium gespeichert ist, um das Verfahren gemäß einem der Ansprüche 6 bis 10 auszuführen, wobei das Computerprogramm auf der elektronischen Steuereinheit oder an einem anderen an die elektronische Steuereinheit angeschlossenen oder zur Kommunikation mit der elektronischen Steuereinheit eingerichteten Computer ausgeführt wird.

Revendications

1. Procédé de meulage d'une pièce au moyen d'une meule (6) essentiellement symétrique de rotation, la pièce comprenant une surface de palier cylindrique (3), une paroi latérale à étendue radiale (4) s'étendant vers l'extérieur à partir de la surface de palier cylindrique, et une partie de transition courbe (5) reliant la surface de palier cylindrique à la paroi latérale, dans lequel la meule a une étendue axiale inférieure à l'étendue axiale de la surface de palier cylindrique, le procédé comprenant le meulage de la pièce en une pluralité d'incrément de meulage définissant ensemble un cycle de meulage, chaque incrément de meulage étant effectué avec une avance respective de la meule par rapport à la pièce, **caractérisé en ce que**, à chaque incrément de meulage, l'avance est sélectionnée de façon à obtenir une température de surface maximale prédéfinie de la pièce en un point de la meule résultant en la température de surface la plus élevée de la pièce.
2. Procédé selon la revendication 1, dans lequel l'avance comprend une avance axiale et une avance radiale, et l'avance axiale et l'avance radiale sont sélectionnées indépendamment de façon à obtenir ladite température de surface maximale prédéfinie de la pièce au point de contact de la meule résultant en la température de surface la plus élevée de la pièce.
3. Procédé selon l'une quelconque des revendications précédentes, dans lequel la meule est entraînée en rotation à une vitesse de rotation constante sur tout le cycle de meulage.
4. Procédé selon l'une quelconque des revendications précédentes, dans lequel la pièce est entraînée en rotation à une vitesse de rotation constante sur tout le cycle de meulage.

5. Procédé selon l'une quelconque des revendications précédentes, dans lequel la pièce est un maneton (2) d'un vilebrequin (1).

6. Procédé de détermination de paramètres de traitement d'un procédé de meulage pour le meulage d'une pièce au moyen d'une meule (6) essentiellement symétrique de rotation, ayant un profil de meule, la pièce comprenant une surface de palier cylindrique (3), une paroi latérale à étendue radiale (4) s'étendant vers l'extérieur à partir de la surface de palier cylindrique, et une partie de transition courbe (5) reliant la surface de palier cylindrique à la paroi latérale, dans lequel la meule a une étendue axiale inférieure à l'étendue axiale de la surface de palier cylindrique, le procédé comprenant, sur la base d'une température de surface maximale prédéfinie (θ^*), la détermination d'un nombre (n) d'incrément et de l'avance axiale ($a_{z,j}$) et l'avance radiale ($a_{x,j}$) respectives desdits incréments, le procédé comprenant les étapes suivantes :

a) sur la base d'une position de la meule à la fin du cycle de meulage, détermination de la distance ($d_{z,j}$, $d_{x,j}$) à l'intérieur de la pièce dans la direction respectivement radiale et axiale, et donc détermination de la partie de contact correspondante définie par une limite inférieure ($s_{0,j}$) et une limite supérieure ($s_{1,j}$) du profil de meule (401) ;

b) détermination d'une avance axiale ($a_{z,j}$) et d'une avance radiale ($a_{x,j}$), sur un incrément correspondant, nécessaires pour maintenir la température de surface maximale prédéfinie (θ^*) en un point de la partie de contact de la meule résultant en une température de surface la plus élevée de la pièce (402) sur ledit incrément correspondant ;

c) sur la base de l'avance axiale ($a_{z,j}$) et de l'avance radiale ($a_{x,j}$) déterminées à l'étape b), détermination de la position de meule résultante après achèvement d'un incrément avec lesdites avances axiale et radiale ;

d) sur la base de la position de meule obtenue à l'étape c), détermination d'une partie de contact correspondante avec une limite inférieure et une limite supérieure correspondantes du profil de meule (403) ;

e) au cas où la limite inférieure de la partie de contact est inférieure à la limite supérieure de la partie de contact obtenue à l'étape d), répétition des étapes b) à d) jusqu'à ce que la limite de contact inférieure de la partie de contact ne soit plus inférieure à la limite supérieure (404) ;

f) indexation des incréments (i) obtenus et de leurs avances axiale et radiale respectives conformément au processus de meulage (405).

7. Procédé selon la revendication 6, dans lequel la détermination de l'avance axiale ($a_{z,j}$) et d'une avance radiale ($a_{x,j}$) nécessaires pour maintenir la température de surface maximale prédéfinie (θ^*) en un point de la partie de contact de la meule résultant en une température de surface la plus élevée de la pièce à l'étape b) est effectuée de façon à obtenir un taux de retrait de matière maximal sur l'incrément correspondant.

8. Procédé selon l'une quelconque des revendications 6 ou 7, dans lequel l'avance axiale et l'avance radiale sont déterminées à l'étape b) par calcul d'une profondeur de coupe limite (a^*e) en fonction de la position (s) sur le profil de meule afin de correspondre à la température de surface maximale prédéfinie (θ^*), sélection de deux points critiques de la fonction de profondeur de coupe limite (S_{cr1} , S_{cr2}) dans l'intervalle de contact en cours, et utilisation des deux points critiques pour déterminer l'avance axiale et l'avance radiale correspondantes.

9. Procédé selon la revendication 8, dans lequel la fonction de profondeur de coupe limite est donnée par l'équation suivante (Eq. 22)

$$\theta^* = \frac{1.064}{\sqrt{k\rho c_p}} e_w [aggr(s, a_e^*)] \sqrt{\frac{v_s}{10^6} a_e^* aggr(s, a_e^*)} \Rightarrow a_e^* = a_e^*(s, \theta^*) \quad (Eq. 22)$$

où θ^* est la température de surface maximale prédéfinie, k est la conductivité thermique du matériau de la pièce, ρ est la densité du matériau de la pièce, c_p est la chaleur spécifique du matériau de la pièce, e_w est l'énergie spécifique à l'intérieur de la pièce, v_s est la vitesse de la meule et $aggr$ est le coefficient d'agressivité.

10. Procédé selon la revendication 9, dans lequel la caractéristique d'énergie spécifique totale, $e_{tot}(aggr)$, est obtenue par des mesures de puissance de meulage effectuées dans une première étape comprenant uniquement un meulage de la paroi latérale dans lequel seule une avance axiale est utilisée, et une deuxième étape comprenant uniquement un meulage de la surface de palier cylindrique dans lequel seule une avance radiale est utilisée ; et dans lequel l'énergie spécifique totale dans la région de transition est obtenue par interpolation exponentielle ; et dans lequel la caractéristique d'énergie spécifique à l'intérieur de la pièce $e_w(aggr)$ est déterminée par calcul de coefficients de

EP 3 115 149 B1

partage d'énergie et application de ceux-ci à la caractéristique d'énergie spécifique totale pour chaque type de meulage séparément ; et dans lequel l'énergie spécifique dans la région de transition est de nouveau obtenue par interpolation exponentielle.

- 5
- 11.** Programme informatique (P) pour la détermination de paramètres de traitement d'un procédé de meulage, dans lequel ledit programme informatique comprend un code programme pour l'exécution des étapes de procédé selon l'une quelconque des revendications 6 à 10.
- 10
- 12.** Programme informatique selon la revendication 11, conçu en outre pour fournir lesdits paramètres de traitement déterminés à une unité de commande électronique ou à un autre ordinateur connecté à l'unité de commande électronique ou adapté pour communiquer avec elle.
- 15
- 13.** Produit de programme informatique contenant un code programme stocké sur un support lisible par un ordinateur pour l'exécution du procédé selon l'une quelconque des revendications 6 à 10, ledit programme informatique étant exécuté sur une unité de commande électronique ou sur un autre ordinateur connecté à l'unité de commande électronique ou adapté pour communiquer avec elle.

20

25

30

35

40

45

50

55

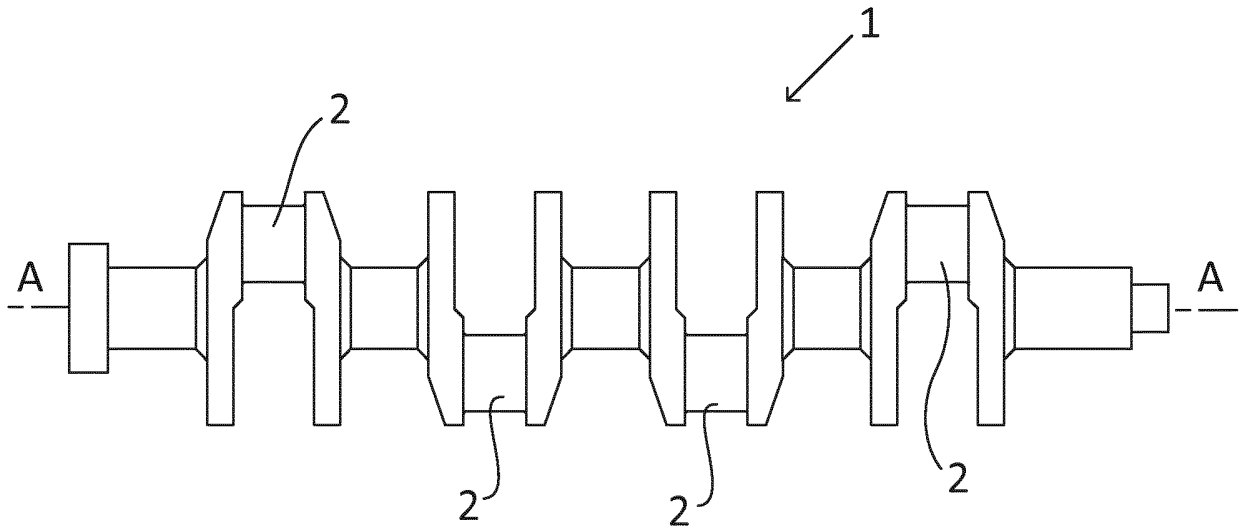

Fig 1a

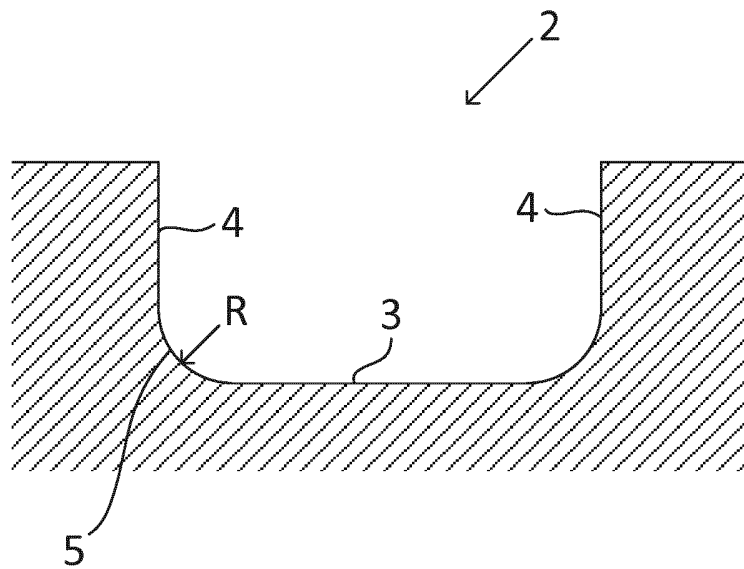

Fig 1b

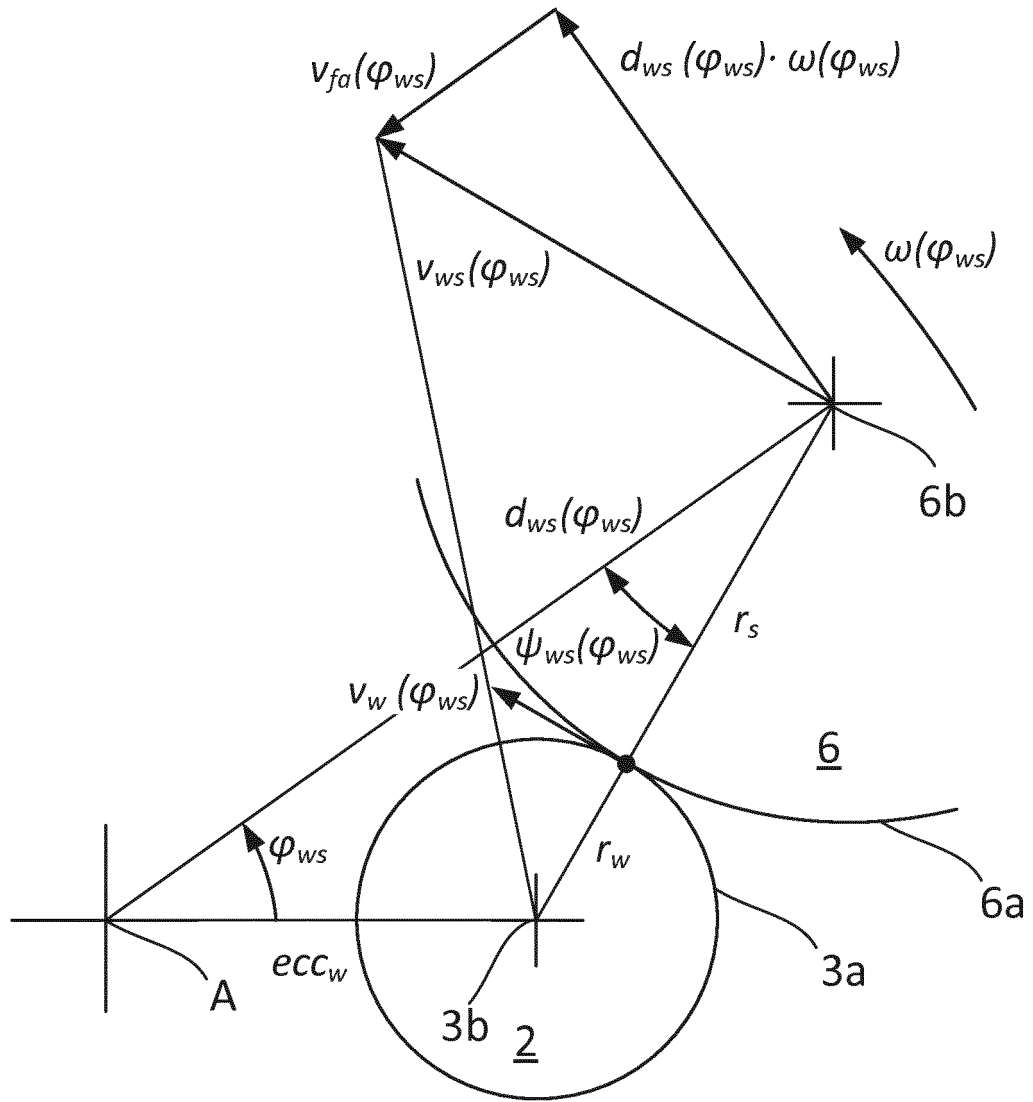

Fig 2

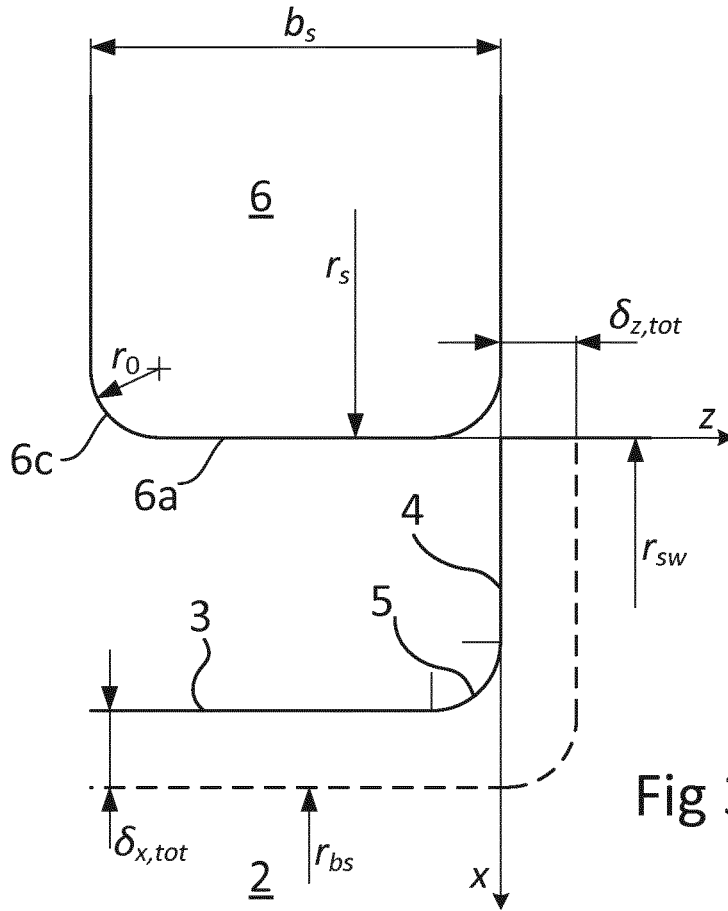

Fig 3a

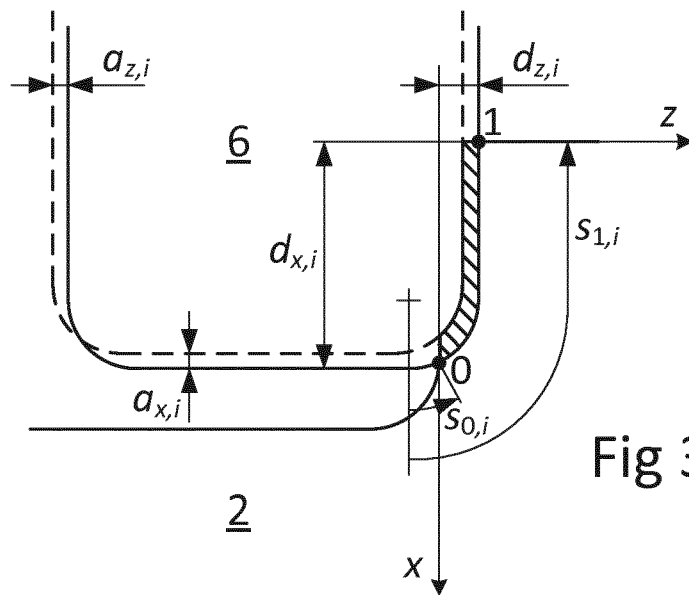

Fig 3b

Fig 4

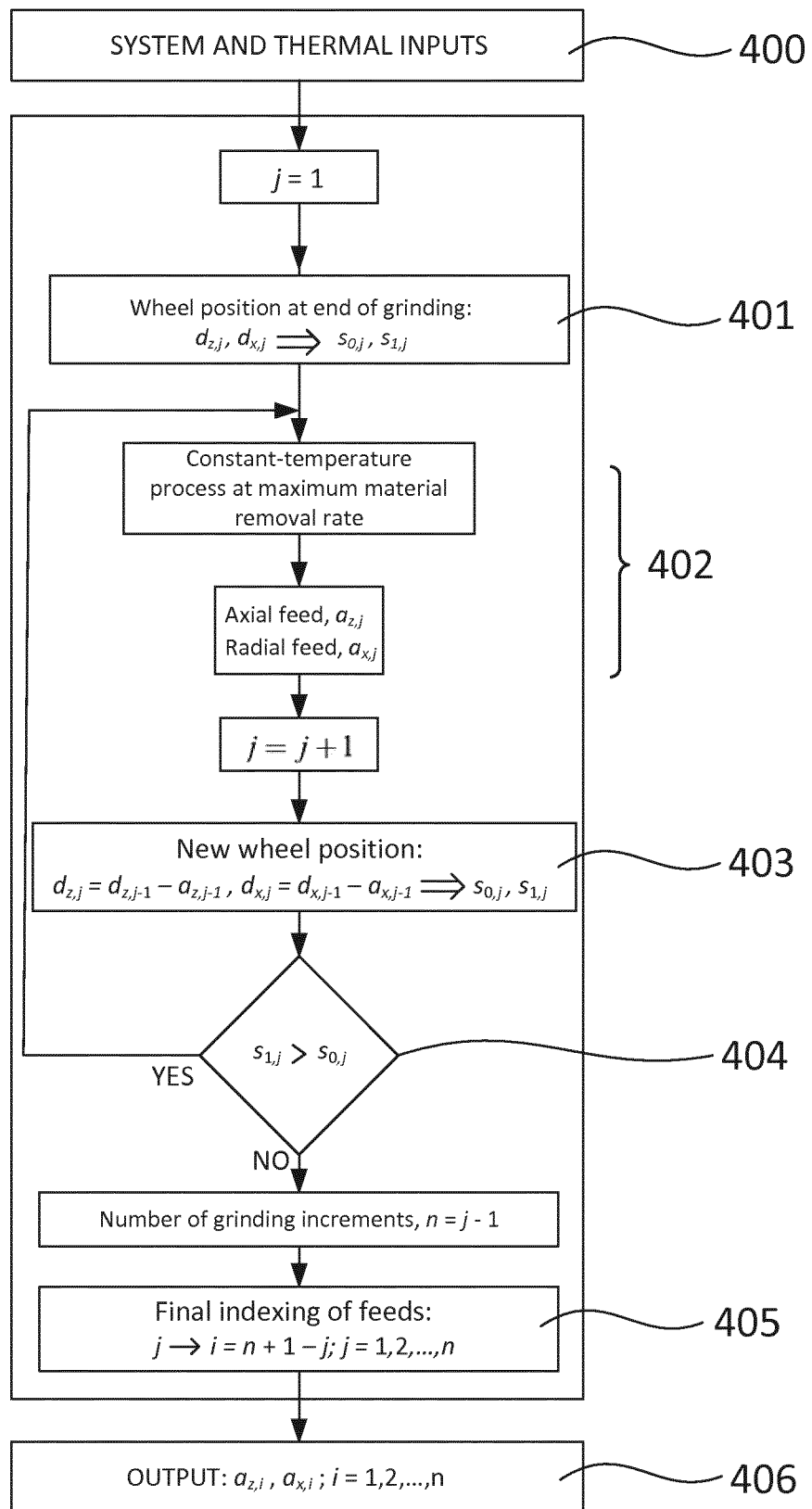
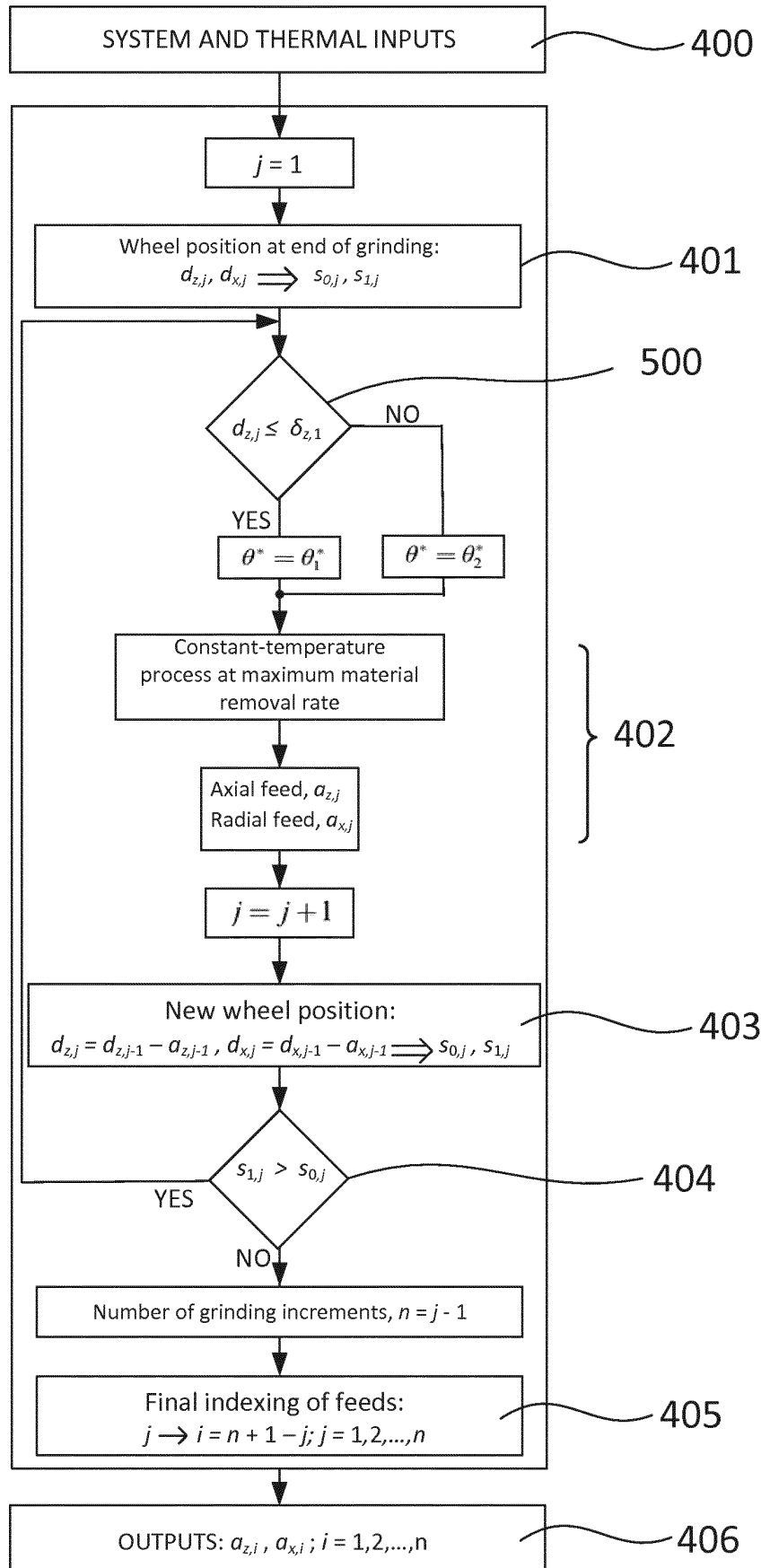

Fig 5



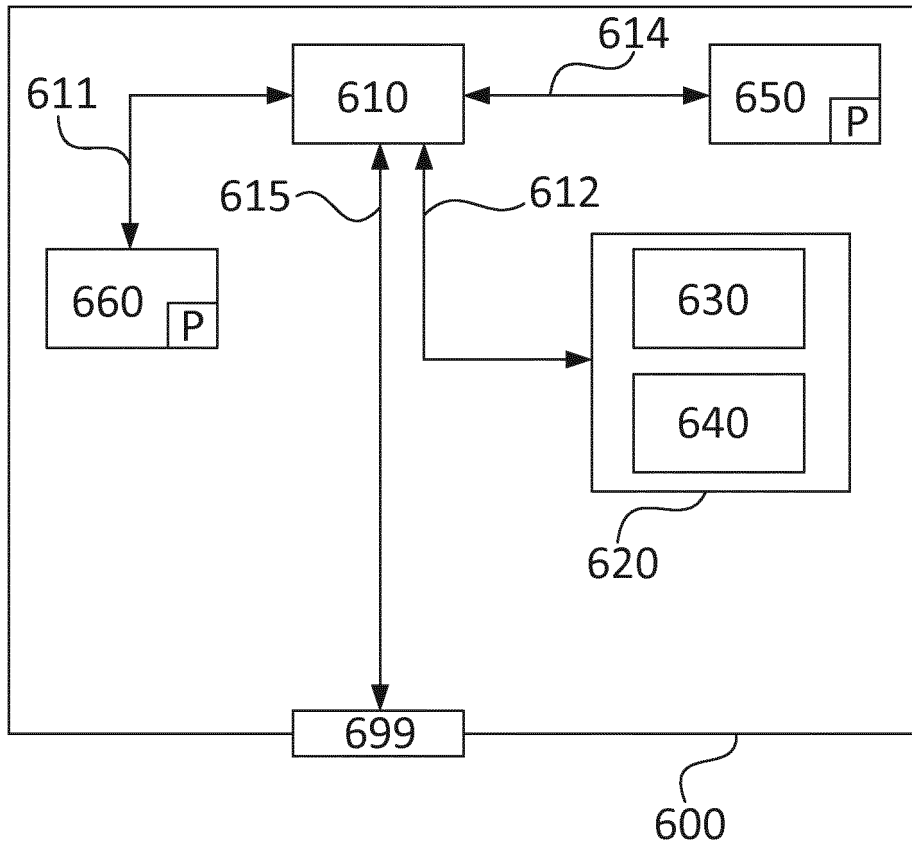

Fig 6

REFERENCES CITED IN THE DESCRIPTION

This list of references cited by the applicant is for the reader's convenience only. It does not form part of the European patent document. Even though great care has been taken in compiling the references, errors or omissions cannot be excluded and the EPO disclaims all liability in this regard.

Patent documents cited in the description

- EP 1635989 B1 [0006]
- US 4603514 A [0007]
- US 6878043 B1 [0008]

Non-patent literature cited in the description

- **MALKIN ; GUO.** *CIRP Annals - Manufacturing Technology*, 2007, vol. 56 (2), 760-782 [0003]
- **OLIVEIRA et al.** *CIRP Annals - Manufacturing Technology*, 2005, vol. 54 (1), 269-272 [0008]