



## Evaluation of BIM-based LCA results for building design

Downloaded from: <https://research.chalmers.se>, 2026-04-06 14:23 UTC

Citation for the original published paper (version of record):

Hollberg, A., Genova, G., Habert, G. (2020). Evaluation of BIM-based LCA results for building design. *Automation in Construction*, 109. <http://dx.doi.org/10.1016/j.autcon.2019.102972>

N.B. When citing this work, cite the original published paper.



## Evaluation of BIM-based LCA results for building design

Alexander Hollberg<sup>a,b,\*</sup>, Gianluca Genova<sup>a,c</sup>, Guillaume Habert<sup>a</sup>

<sup>a</sup> Chair of Sustainable Construction, Institute of Construction and Infrastructure Management, ETH Zurich, Stefano Franscini Platz 5, 8093 Zurich, Switzerland

<sup>b</sup> Department of Architecture and Civil Engineering, Chalmers University of Technology, 41296 Gothenburg, Sweden

<sup>c</sup> Integrated Digital Planning Team, Basler & Hoffman, Switzerland

### ARTICLE INFO

#### Keywords:

Building Information Modelling (BIM)  
Life Cycle Assessment (LCA)  
Performance assessment  
Design process

### ABSTRACT

Digital tools based on Building Information Modelling (BIM) provide the potential to facilitate environmental performance assessments of buildings. Various tools that use a BIM model for automatic quantity take-off as basis for Life Cycle Assessment (LCA) have been developed recently. This paper describes the first application of such a BIM-LCA tool to evaluate the embodied global warming potential (GWP) throughout the whole design process of a real building. 34 states of the BIM model are analysed weekly. The results show that the embodied GWP during the design phase is twice as high as for the final building. These changes can be mainly attributed to the designers' approach of using placeholder materials that are refined later, besides other reasons. As such, the embodied GWP is highly overestimated and a BIM-based environmental assessment during the design process could be misleading and counterproductive. Finally, three alternatives to the established automatic quantity take-off are discussed for future developments.

### 1. Introduction

The built environment has a high impact on the environment and is responsible for more than one third of global greenhouse gas (GHG) emissions [1]. Due to the implementation of energy efficiency regulations in most industrialised in the last years, the operational energy demand and associated GHG emissions of new buildings have been very much reduced [1]. In consequence, the share of embodied energy and GHG emissions due to the manufacturing, replacement and disposal of building materials gained importance [2]. In new, energy efficient residential buildings the embodied environmental impact makes up about half of the total GHG emitted in a life time of 50 years [3]. This clearly shows the need for a holistic assessment of the whole life cycle. Life Cycle Assessment (LCA) is increasingly applied for assessing the environmental performance of buildings in research, but also in practice – most times in form of a post-design evaluation for sustainability certification purposes, e.g. DGNB [4].

LCA covers the entire life cycle of buildings from raw materials extraction and processing, manufacturing of building components, to use and end-of-life. The method as described in ISO 14040 [5] consists of four phases: goal and scope definition, life cycle inventory (LCI), life cycle impact assessment (LCIA), and interpretation [5,6]. While for the LCA of products these four phases are used, predefined datasets for the

materials or components are used in most cases of building LCA. As such, the LCI and LCIA are merged into one step and simplified [7]. The bill of quantities (BoQ) of the individual materials is multiplied with pre-calculated values from an LCA database. The results are summed up under consideration of the reference service life of the individual components. Nevertheless, the LCA of buildings is a complex task because of the large amount of information required and time-consuming nature of the method [8]. Most time and effort is needed to establish the BoQ and find the correct datasets in the building material LCA database. As such, LCA also means a high effort and therefore a high cost for sustainability certification. As a result, the LCA of buildings is commonly conducted at the end of the design process, when the necessary information is available, but it is too late to affect the decision-making process [9,10]. However, this post-design evaluation through LCA is not sufficient on its own, as it does not improve the environmental performance of the design [11]. To minimize environmental impacts, an integration of LCA into the architectural design process is needed, especially in the early design phases, as these have the highest influence [12].

Digital tools based on Building Information Modelling (BIM) provide the potential to decrease the additional effort for LCA and speed up the process. Especially in the last five years, scientific studies about using BIM for LCA have been increasingly published in the literature

\* Corresponding author at: Department of Architecture and Civil Engineering, Division of Building Technology, Chalmers University of Technology, 41296 Gothenburg, Sweden

E-mail address: [alexander.hollberg@chalmers.se](mailto:alexander.hollberg@chalmers.se) (A. Hollberg).

<https://doi.org/10.1016/j.autcon.2019.102972>

Received 31 May 2019; Received in revised form 21 September 2019; Accepted 25 September 2019

0926-5805/ © 2019 Published by Elsevier B.V.

and new software tools have been developed. Soust-Verdaguer, Llatas, and García-Martínez [13] and Bueno and Fabricio [14] provide an overview and review of the latest developments. Cavalliere [15] provides a recent overview over building LCA including 28 commercial tools of which 7 use a BIM model. In addition, many researchers have developed their own workflows to connect an LCA database with a BIM software, for example linking Autodesk Revit [16] or ArchiCAD [17] with SimaPro or Excel [18]. In many recent studies, the visual programming plug-in Dynamo for Autodesk Revit is used to link the BIM model with and LCA database (for example see [19–22]).

However, the existing studies present methods for conducting BIM-based LCA in a specific design phase [23]. Usually, they are employed for a model with a relatively high level of development (LOD) of LOD 300 or higher in later design stages. No studies found in the literature apply these tools throughout the whole design phase. To provide feedback for designers and inform decision-makers, the LCA results need to be available throughout all design stages, especially in the decisive early design stages [24]. Gantner et al. [25] provide a general concept of applying BIM-based LCA with different levels of detail in different planning stages. However, they only provide the theoretical framework without a case study or real application. Cavalliere et al. [23] provide a concept of linking several databases and provide a theoretical case study for the application of the framework. However, it is not applied during the design of a real building.

This paper investigates whether BIM-based LCA throughout the design process allows for environmental performance improvement. The objective is to study the established approach of linking a quantity take-off from a BIM software with an LCA database and a tool for the assessment of embodied environmental impacts. For the first time, this approach is applied to the design process of a real life case study of an extension of an office building in Switzerland.

## 2. Method

The main concept is to evaluate the potential of continuously applying BIM-based LCA throughout the design process by means of a real-life case study. Here, the LCA is carried out after the planning phase of the building. The goal is to evaluate the value of a continuous feedback of LCA results for guidance to the design team to improve the environmental performance during the design phase.

The following section consists of two parts. The first part describes the current established BIM-LCA workflow and the tool used to calculate the embodied environmental impacts based on the bill of quantities from the BIM model. The second part describes the tracking of the development of the BIM model throughout the design process by “freezing” the current stage each week. This approach is exemplified by means of a real case study.

### 2.1. Using BIM for the calculation of embodied environmental impacts

To assess the embodied environmental impacts of the building based on the BIM model a tool is developed in Dynamo for Autodesk Revit. An overview of the method for the tool is described in the following.

The method follows five main steps (see Fig. 1) that are explained in

the following.

#### 2.1.1. Linking the BIM software's native material library with LCA data for building materials

Every BIM software has its native material library which is used in the whole project. The material library is associated with the building's geometry allowing to extract from each building element the contained quantities and material information. However, information on the embodied impacts for each material is not included in the native material library. Therefore, a library with LCA data for building materials needs to be linked.

For this project, the Swiss LCA database for building materials and products called *Ökobilanzdaten im Baubereich* by KBOB [26] is used. It provides generic LCA data for most typical building materials for the manufacturing (life cycle modules A1–A3 according to EN 15978 [27]) and end-of life (modules C3 + C4). In addition, datasets for transportation are provided, but these are not employed in this project. The database is based on Ecoinvent V2.2 and updated regularly. It provides values for the indicators global warming potential (GWP) and non-renewable primary energy (PENr). In addition, a single-score indicator called *Umweltbelastungspunkte* is provided. This indicator is specifically calculated for Switzerland based on the method of ecological scarcity [28]. The values are provided per mass (for example metals) or per surface area (for example window panes). Each material has an individual KBOB ID. This ID is used to manually link the LCA factors with the materials used in the Autodesk Revit file.

#### 2.1.2. Writing the LCA material ID to the BIM software

The manually established link is saved in a spreadsheet and imported into Dynamo. This file can be used to write the KBOB ID into the material information for different Revit files. This is important as later various Revit files are used to analyse the embodied impacts throughout the design process. Furthermore, the linking can be used for other projects, as long as the convention to name the materials in the BIM software stays the same.

#### 2.1.3. Take-off of quantities

The BIM software is used to calculate the volume or area of each building component and establish a BoQ including the KBOB ID. This process works well for construction elements, such as walls or windows. For technical elements the calculations needs to be adapted. Technical elements are grouped into two subgroups: technical routing and technical devices.

Dynamo cannot directly access the volumetric information of technical routing elements such as pipes, ducts, or cable trays, which makes the calculation of the mass of these components difficult. One solution is to calculate each cross section and multiply it with the length of the reference line to provide the volume and correspondingly the mass for each routing element. Another difficulty is that the KBOB database does not contain explicit materials for technical systems of the building. In the conventional Swiss approach for building LCA, the environmental impact of technical systems is estimated based on average values and the amount of heated floor area. For this paper, the general materials from KBOB databases are used to calculate the LCA of technical system elements.

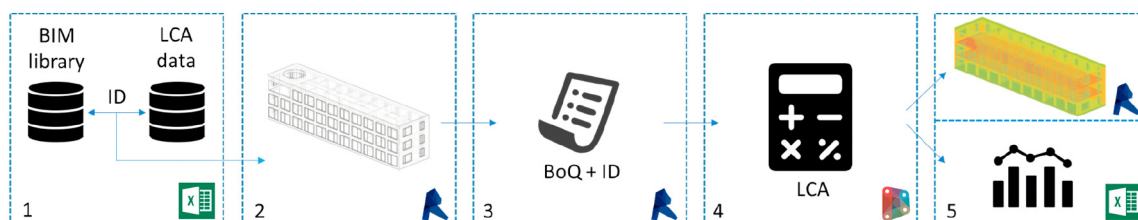

Fig. 1. Flowchart of the calculation of embodied impacts based on Revit and Dynamo.

The geometry of technical devices are usually simplified in BIM models for performance reasons and used as a placeholder. Even when the level of geometry is high and illustrates the real product, it does not contain the internal components. Therefore, producers ideally provide the material content of their products and the embodied environmental impact. However, this data is currently usually not available requiring an alternative method to calculate the material content of each technical object in the model. Here, technical devices are separated into two groups: elements with material information and elements, which do not have any material reference. If the material information is available, the calculation can be done similar to the construction elements. If no information is available, the main material content is identified as the possible material and a percentage of the total volume is assumed. However, this method is clearly not very accurate and should be replaced by product-specific data in the future.

#### 2.1.4. LCA calculation

The BoQ is transferred to Dynamo where the embodied impacts are calculated. The quantities of each material are multiplied with the LCA factors from the KBOB database. Depending on the type of component, a reference service life is assigned according to SIA 2032 [29]. The number of replacements is calculated to include the impact due to replacement of materials (life cycle module B4).

#### 2.1.5. Exporting of results and visualisation in the BIM software

After the calculation in Dynamo the results can be exported in various formats. Here, they are written to a spreadsheet for documentation purposes. Furthermore, the results are written back to the BIM software to allow for visualisation through colour codes on the BIM model.

### 2.2. Assessment through the design process

The design process of a building is continuous and correspondingly the BIM model evolves continuously. To be able to track the development of the BIM model, the current state of the model is “frozen” each week. This allows to later evaluate the development of the model and track the time when design decisions have been made. The developed LCA tool was applied to analyse the embodied impact of each “frozen” model.

Here, the design process of a real case study building is analysed. The case study is the three storey extension of an office building of the engineering company Basler&Hofmann in Esslingen, Switzerland (see Fig. 2). The project was a pilot to test the building process only based on the digital model without printed 2D plans. The project is an exemplary

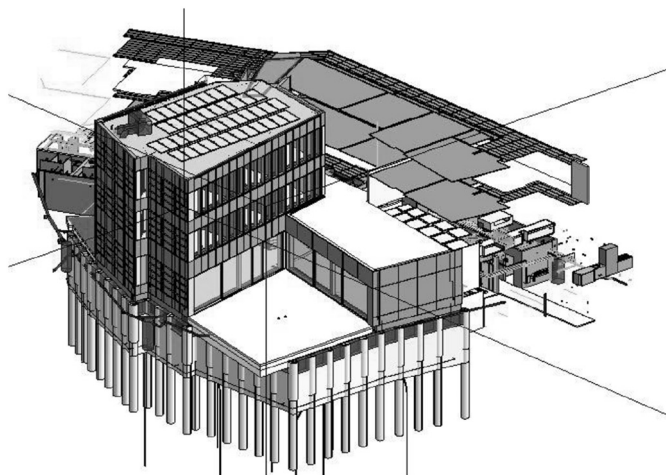

Fig. 2. BIM model of the case study building with the extension and new components in the existing office building.

project for Switzerland and won the international AEC Excellence Awards 2018 in the category small buildings.

The building permit application took place in December 2017 and until then the LOD of the model was low. In this pre-design phase (September–December 2017), the first four BIM models were saved every month. From January 2018 to August 2018, 30 model states were saved, resulting in 34 models for analysis. The construction started end of May 2018 and the planners were supposed to deliver their final design until week 18.

The workflow as described in Section 2.1 was employed for each of the 34 models. Dynamo was used to write the KBOB IDs to the BIM model, the BoQ was established, the embodied GWP including necessary replacements was calculated in Dynamo and the results were exported to an Excel spreadsheet. The developed Dynamo script follows this workflow. To simplify the calculation, it was split into twelve parts (see Table 1) and carried out one after another by using Dynamo player<sup>1</sup>.

Here, only the indicator GWP is used for analysis, but the same approach can be used for all other indicators in the LCA database. The later versions of the model were highly detailed as they provide the basis for the construction. This resulted in a large number of elements and an extended calculation time. The total calculation time for one model was about 30 min.

## 3. Results

The results for embodied GWP for the 34 models are plotted in Fig. 3. Surprisingly, the total value for GWP does not continuously increase as the design develops and the BIM model becomes more accurate. The maximum GWP is achieved in week 8 and then lowered to the final stage. To analyse reasons for this development, the results are analysed in more detail.

In the following, the results for the building construction and the technical elements are discussed separately.

### 3.1. Construction elements

The results for the construction elements are plotted in Fig. 4. A number of observations can be made:

1. The individual elements show peaks in different weeks.
2. The results for all elements rise to a peak and then decrease to the final result.
3. All elements seem to have reached a final result in the last 3 weeks (no changes) while some elements receive this final stage already earlier.
4. The results for most elements do not change much after week 18.

The change of the results for embodied GWP can have three reasons: a) a change in the number of elements, b) a change in the volume of the existing elements, c) a change in the material that is assigned to these elements.

The number of elements in the model in Fig. 4 can be used as a proxy for the degree of refinement of the model. The number of elements increases for most categories throughout the design process. Only the category curtain wall shows higher numbers until week 9 and a reduction of more than half in week 10. The continuously increasing number of elements is in contrast to the evolution of the embodied impact throughout the design phase. Therefore, this shows that the elements have been modelled in higher detail reducing the overall quantity of material or the material has been changed. It is interesting to see that the peak of embodied GWP in Fig. 4 does not occur at the

<sup>1</sup> An exemplary application of the script can be seen in a video at <https://www.youtube.com/watch?v=DetQXx-FZvA&t=4s>.

**Table 1**  
Dynamo script module overview.

|                       |  |
|-----------------------|--|
| Preparation           | M0_Material List Fill: Based on a pre-trained material mapping spreadsheet the missing KBOB numbers are filled in the native material library<br>M1_Create Project Parameter: LCA parameters for each element as well as the global parameters are generated   |
| Construction elements | M2_Fill Global Parameter: General information about the project model to the global parameters are added<br>M3_Wall: Analyse all wall elements and calculate environmental impact<br>M4_Floor: Analyse all floor elements and calculate environmental impact<br>M5_Structural: Analyse all structural elements and calculate environmental impact<br>M6_Envelope: Analyse all external and facade elements and calculate environmental impact<br>M7_Interior: Analyse all interior elements and calculate environmental impact |
| Technical elements    | M8_Technical Routing: Analyse all technical routing elements like pipe, ducts, cable trays and calculate environmental impact<br>M9_Technical Devices: Analyse all technical device like lightings, equipment, plumbing fixtures, etc. and calculate environmental impact  |
| Results               | M10_View Duplicate: Duplicate the open 3D view to provide an illustration for the LCA Results<br>M11_Visualisation: Colour the elements in the duplicated view to illustrate the ones are above or below limit values<br>M12_LCA Report: Generate a summary report from the LCA of the BIM model and export to a spreadsheet   |

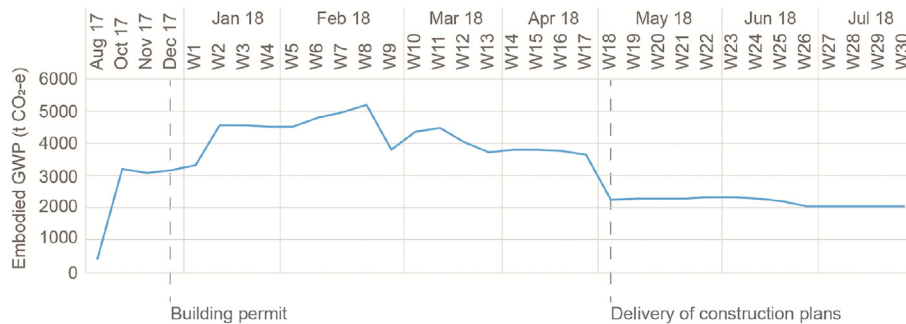

**Fig. 3.** Evolution of total results for embodied GWP in t CO<sub>2</sub>-e throughout the design process.

same time depending on the nature of the element. The peak of the wall elements is then followed by one for slabs. Both are related to the structural design. The peak for hanging ceilings occurs later, even after the delivery of the construction plans in week 18. This observation confirms previous assumptions that the structure, envelope, technical equipment, and finishing are not defined with the same LOD along the design phases [23].

In the following, slabs and walls are analysed in more detail, because they are responsible for the highest environmental impact. Furthermore, they are usually defined early in the design process. In Fig. 5, it can be seen that both walls and slabs rise from the beginning of the design process and reach a peak in week 8. From there on, the environmental impact slowly reduces until it reaches a steady impact level after week 18. The walls show a big drop from week 17 to 18. However, the number of elements in Fig. 5 show only small changes throughout the design process and no difference between week 17 and 18 for the walls. As such, the only reason for this reduction of impact can be the modelling of elements with a higher level of detail.

The BIM model that served for the construction was supposed to be finished in week 18 and construction started end of May. As such, especially all structural elements need to have reached the highest level of detail. It is then interesting to see that from the results for the walls based on the BIM model in the design phase to the BIM model ready for construction, the embodied GWP has been divided by a factor 3. These changes can be explained by the fact that the designers modelled the initial slabs and walls very roughly. In the early design stage of the project, the layers and material content were not clearly defined and served as temporal placeholders. The elements therefore were represented by thick massive concrete blocks with the total thickness of the element. As the elements get more refined and detailed over time, the embodied impact gets closer to the real environmental impact.

### 3.2. Technical equipment

The results for the embodied GWP of the technical equipment are plotted in Fig. 6. Two main observations can be made.

1. In contrast to the construction elements, only the mechanical equipment shows a big peak in week 8 whereas most elements continue to rise to the final results.
2. There are no changes visible after week 24.

Analysing the evolution of the number of technical elements in the BIM model shows a general continuous growing number. Even the number of mechanical equipment is much lower in week 8 where the peak for the GWP results appears than in the final model. Interestingly, the extreme growth of the number of elements for pipes cannot be seen in the results for the embodied GWP.

## 4. Discussion

### 4.1. Limitations of LCA based on BIM quantity take-off during the design

In this case study, the assessment of embodied environmental impacts was not part of the design process and the results presented here are only derived from a post-design assessment. As such, the results could not be used during the design process to reduce embodied impacts. The embodied impact has not been a design parameter in this project and no other tools were used to assess the environmental impacts. As such, it can be assumed that there has been no optimization towards lowering the embodied impacts. The Dynamo tool for the BIM-based LCA presented here is state of the art and similar to the approaches of other researchers (for example see [19–22]), but adapted to the Swiss context. Ideally, such an approach could be integrated into the design process in future projects. Therefore, the benefits for providing design guidance towards reducing the environmental impacts are discussed in the following.

The results for the embodied GWP derived during the design process are very different from the final result. Fig. 3 shows that the total impact of the building in week 8 is more than twice as high as the final impact. As such, the value of the results in week 8 is difficult to use for design guidance. In this case study, the BIM model was used for the application of the building permit. Different countries consider making

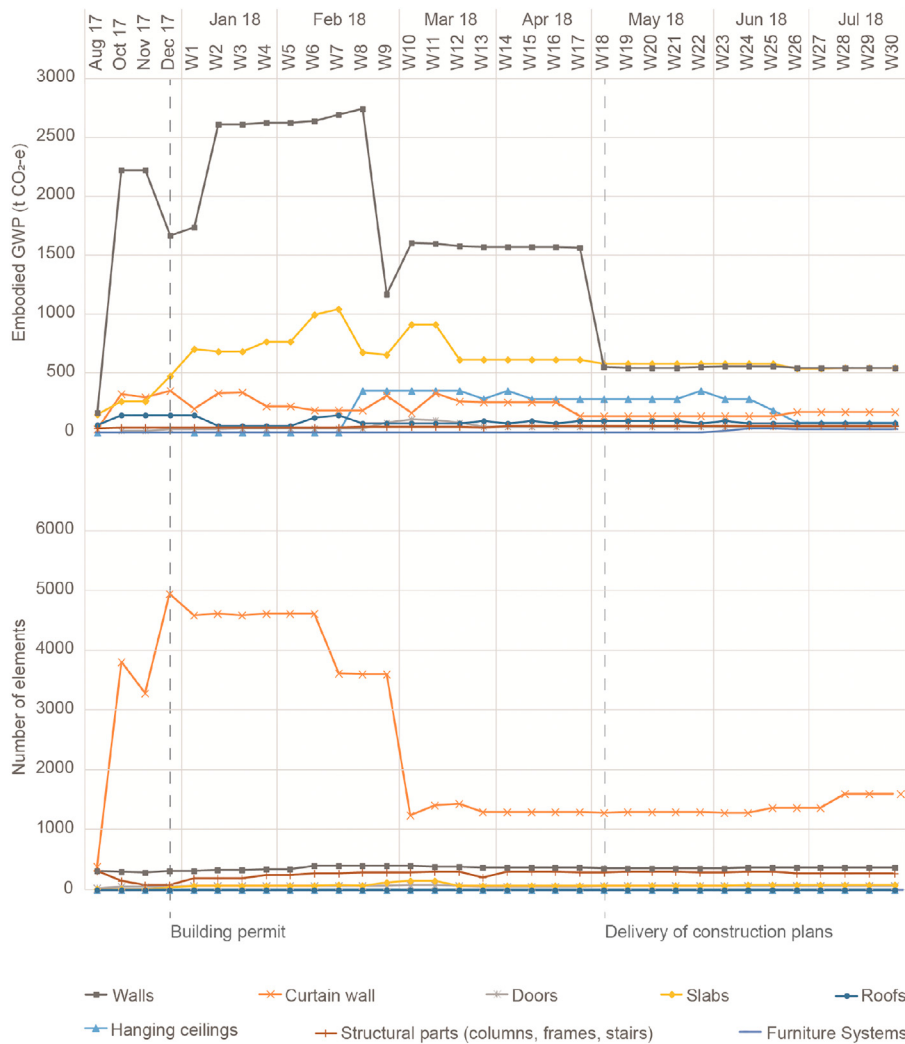

Fig. 4. Results for the construction elements for embodied GWP in t CO<sub>2</sub>-e and the number of elements.

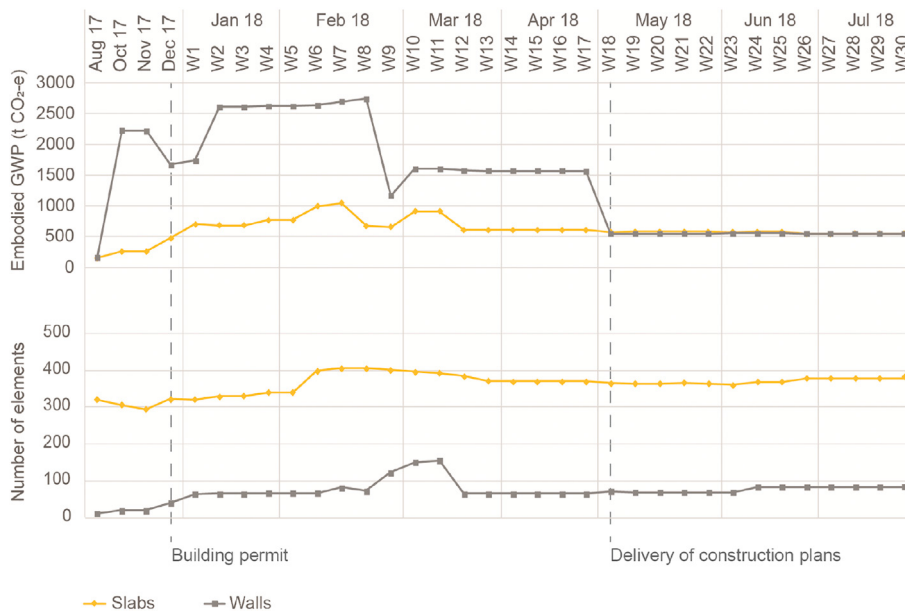

Fig. 5. Results for walls and slabs for embodied GWP in t CO<sub>2</sub>-e and the number of elements.

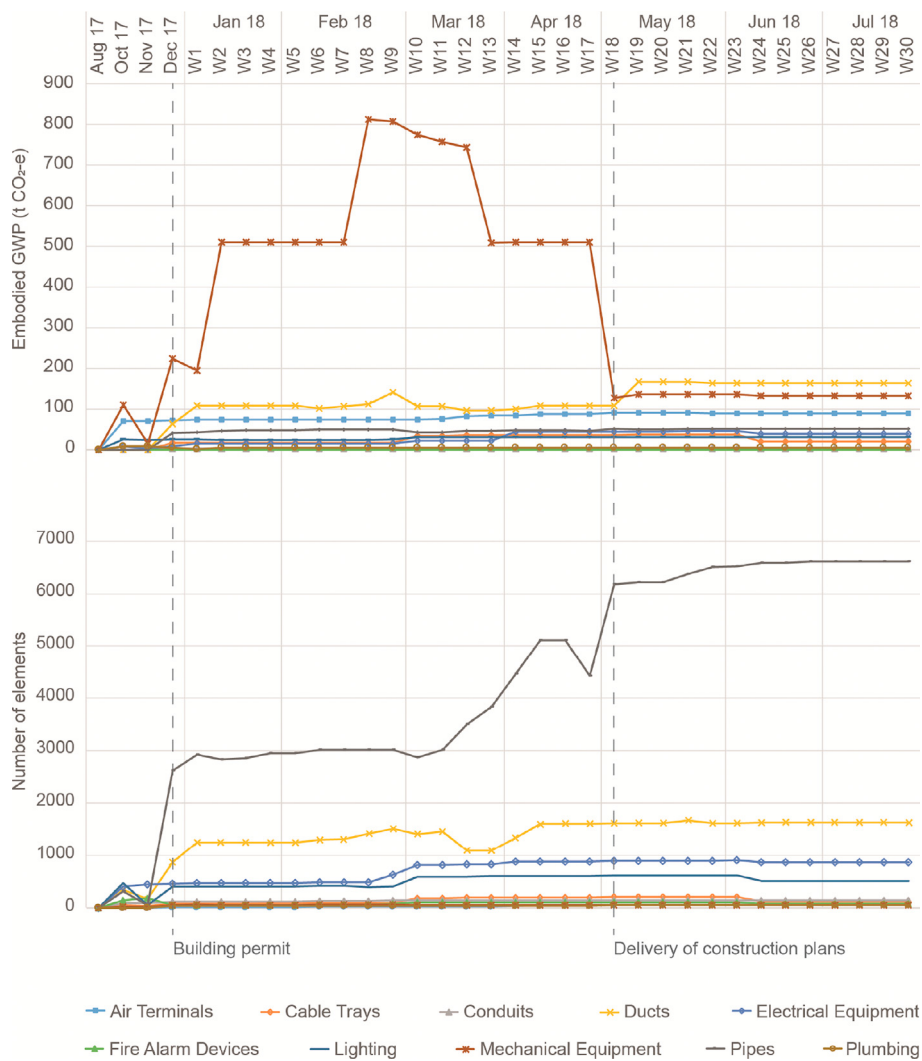

Fig. 6. Results for the technical equipment for embodied GWP in t CO<sub>2</sub>-e and the number of elements.

an assessment of embodied impacts a mandatory part of the building permit application process as this is already the case for the operational energy in the form of energy performance certificates. The Netherlands have introduced a mandatory LCA for office buildings already [30]. It would appear obvious to use the same BIM model to assess and certify the embodied environmental impacts for the building permit. However, the results for this case study clearly show that the inaccuracies compared to the final results are much too high.

The change in the results can be due to a change of quantity or material. The number of elements vary through the design process, but do not correspond to the changes in the results. This means that the level of detail of an element is changed, leading to a more accurate modelling and less quantity of material or an element is assigned a different material.

The quality of the results depends foremost on the quality of the assessment tool and the quality of the model. In this case study, the same tool was employed for each state of the BIM model. It can be assumed that potential errors in linking the materials or the calculation process of the tool are the same for each model state. As such, the difference in the results depends only on the quality of the model.

The designers used placeholder in early design stages. This process is analysed using a wall element as example. Fig. 7 shows the visual representation of this element in Autodesk Revit for three stages in the design process (October 2017, April 2018, and July 2018). Small changes between the first and the second representation can be seen,

while the third one seems to be identical with the second one. This visual representation can be described as Level of Geometry.

Next to the geometrical representation, the available information needs to be considered for the LCA. This aspect is also referred to as the Level of Information. The number of elements and materials as well as the area and the volume are shown in Table 2. In October, the wall was modelled as two separate elements with one material each. In April and July the wall was modelled as one element with five material layers. It can be assumed that in October the wall was not yet defined, but a placeholder was used. The volume shown in Table 2 is the sum of the volumes of the materials. The volume in July is about 40% smaller than in April. It can be assumed that in April some materials were overlapping and that these mistakes were corrected afterwards.

In this case study, the model has not been checked for quality regarding LCA. Issues such as overlapping materials could be automatically checked for by model checkers. Pilots are currently being developed [31]. Furthermore, model view definitions (MVD) could serve as basis to include only the relevant elements within the BIM model [25,32]. However, even if these processes are automated and optimized, they require an additional effort for the designers. Especially, in the early design stages, designers want quick results, delivered intuitively without additional effort [24].

The case study was a pilot for the designers involved and the workflow of modelling the building might be adapted in the future. Nevertheless, it can be assumed that designers will continue to work

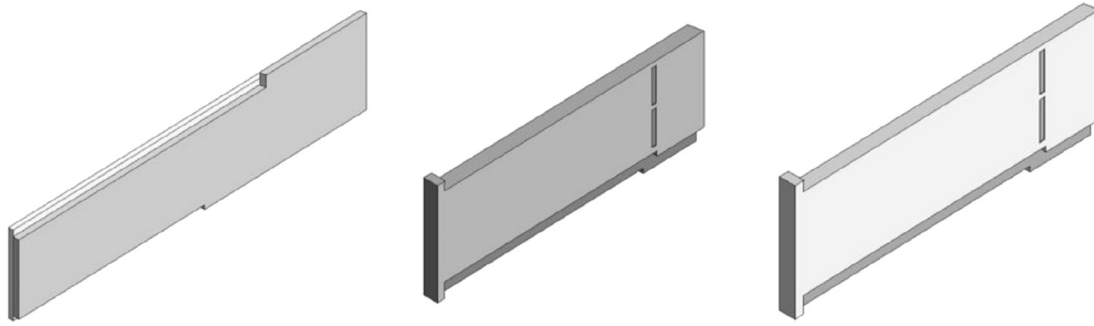

Fig. 7. Visual representation of a single wall in October 2017 (left), April 2018 (middle) and July 2018 (right).

**Table 2**  
Quantity take-off for a single wall.

| Date                     | October 2017 | April 2018 | July 2018 |
|--------------------------|--------------|------------|-----------|
| Number of elements       | 2            | 1          | 1         |
| Number of materials      | 2            | 5          | 5         |
| Area [m <sup>2</sup> ]   | 51.35        | 37.98      | 35.42     |
| Volume [m <sup>3</sup> ] | 12.82        | 18.79      | 11.45     |

with placeholder materials in early design stages and the model will continuously evolve. This would even be more probable if the design is done by an interdisciplinary design team, where each discipline will reserve space in the model to place detailed information later and avoid that other disciplines occupy the space in the meantime. Therefore, the sole calculation of embodied impacts based on the BoQ from the BIM model will not provide a meaningful design guidance. Alternatives for potentially more effective ways are discussed in the following.

#### 4.2. Proposal for effective environmental guidance in a digital workflow

The alternatives to the current state-of-the-art automatic quantity take-off and calculation of embodied impacts are divided into three categories.

##### 4.2.1. Adapt the design workflow

The difficulties of matching materials can be avoided, if designers only use predefined materials. The HVB:ERT tool [33] for example, follows this approach and provides a material library with LCA factors for Revit. In addition, Lee et al. [34] provide green templates for Autodesk Revit with components and materials that contain LCA-related information for the Korean context. As long as only these materials are used, the embodied impact can be easily calculated.

The difficulties of placeholder materials can be avoided if designers only use predefined components. These components need to include all layers and detailed material information. Instead of starting the design process with a basic wall in Revit for example, designers directly choose a wall from a library. Libraries (for example Revit families) can be established within an architectural office or provided by an external service. Lee et al. [34] provide guidelines for designers on how to set up a material library containing the parameters needed for LCA. The number of platforms providing BIM data (e.g. BIMObject<sup>2</sup>) is growing and more and more manufacturers offer components. This is especially useful for products that are commonly used and usually not adapted by the designers, for example technical equipment or furniture. For other components, the use of predefined components might limit the freedom of design and be a barrier for new solutions, such as a new façade assembly, for example. Therefore, some architects might not want to use this approach, especially for innovative projects or in architectural

competitions. Nevertheless, it is an efficient approach for designers that work with standard components in projects with an early definition of materials, for example modular, prefabricated buildings or industrial buildings [35]. It is known that the use of industrialised housing can increase transparency in the supply chain [36] by adopting principles from the manufacturing industry [37]. New business models can be developed which include a much more modular way of designing using a common set of objects [38]. This could be a path to co-develop environmentally efficient and digital construction, but it requires a large change of the complete construction industry and the organisation of the different stakeholders [39].

##### 4.2.2. Adapt the calculation methods for embodied impacts

Instead of using the volumetric definition of building elements, typical simplified LCA approaches only use the information about the area of an element from a 3D model. The building components and materials are assigned from a library and can easily be adapted. This approach is similar to building performance simulation (BPS) using thermal models that only consist of 2D surfaces, sometimes called “shoe-box” models. This approach is followed by CAALA [40], for example. Material variants can easily be evaluated as the model does not need to be changed, but only a new component is selected from a catalogue. In this way, the freedom of designers can be kept in early design changes. The automatic extraction of 3D surface models from volumetric BIM models has been studied for many years in the context of BPS. Farzaneh, Monfet, and Forgues [41] and Gao, Koch, and Wu [42] provide recent literature reviews on the topic. gbXML is a common format for these models and it could be extended to included attributes needed for LCA. Furthermore, direct BIM-BPS links using IFC are developed [43]. Nevertheless, the correct extraction of a thermal model from BIM is still difficult in practice and not established in common architectural offices [41,44].

The use of 2D models has some inherent inaccuracies, such as the overestimation of materials on corners of the buildings or joints between ceilings and walls [45]. In early design stages, these can be neglected, but if the same tool should be used for a sustainability certification, user will want to model their building as accurate as possible. In addition, users might feel that information that are already provided in the BIM model, for example material properties, are not used by the LCA tool. Although the selection of a material from a component catalogue is quickly done, it means a small additional effort.

In early design stages, this approach allows for assessing the embodied impact only based on the geometrical model and assumptions for materials. Instead of requiring the designers to assign placeholder materials for not yet defined components, the LCA tool can estimate the impact with average values or typical reference values depending on the national construction market [46]. This approach is also referred to as “structured under-specification” by Tecchio et al. [47]. Instead of giving out one result, the LCA tool can report a probability range for the embodied impacts depending on the design stage. Rezaei, Bulle, and Lesage [48] combine this approach with Monte Carlo simulation to

<sup>2</sup> <https://www.bimobject.com/>.

provide a distribution for the uncertain results in early design stages.

#### 4.2.3. Use machine learning and advanced techniques in LCA tools

The literature reviews and the results of this paper show that the ideal LCA tool that is easy to use in early design, does not need additional information input, calculates quickly, allows for optimisation throughout the whole design process and allows for an automatic sustainability certification does not exist yet. However, it could be possible that LCA tools learn from previous projects and take adequate assumptions that support the use. For example, if the user modelled a basic wall of 40 cm without material information as a placeholder, the tool could assume a layer of reinforced concrete and an insulation with cladding and plaster depending on the size of the building, the local climate, the local regulations and the materials the user or the architectural office has selected in past projects. This approach can also be described as “semantic enrichment” of the BIM model [49]. Similar to the second approach, the tool could use structured under-specification and report a probability range for the embodied impacts.

Machine learning has been successfully used for operational building performance predictions on building level [50] and for urban areas [51]. Furthermore, using data mining for assessing the environmental impacts of household consumptions has been shown by Frömel [52], for example. Genetic algorithms have been employed to find solutions for environmentally-friendly material combinations [45,53], but machine learning has not yet been applied regarding embodied environmental impacts due to a lack of an adequate database. To allow algorithms to learn, ideally a large database of “as-built” BIM models of buildings with the required information for LCA should be established. Chen, Chang, and Lin [54] provide a framework for storing BIM models to allow for big data analysis. In the future, such a database could be established in cooperation with sustainability certification institutes, such as BRE, LEED or DGNB and tools that provide the certification, e.g. oneclickLCA, Tally and CAALA. Currently, the quality of data of certified buildings does not allow for automatic analysis, yet [55]. Therefore, the data would need to be structured and adapted to allow for machine learning. In addition, as the LCA of buildings is still not mandatory in most countries and the number of buildings that are certified are still small compared to the number of buildings built, it will take a while to gather enough buildings that provide a basis for meaningful assumptions. As such, this approach is promising, but can only be realised in the long-term.

## 5. Conclusion

BIM can reduce the effort of calculating the embodied environmental impacts of buildings and therefore provides the potential to improve the environmental performance of buildings during the design stage. LCA databases for building materials are available in many European countries and North America. The literature shows that there are many frameworks for automatically calculating embodied impacts based on a BoQ from a BIM software in each design stage. As shown in this paper, the necessary tools can be easily developed. However, the first application of such an approach to a real case study shows that the automatic calculation leads to wrong results with the current designers' workflow. This clearly shows the importance of analysis tools that match the design workflow in practice.

Three options to solve this general problem could be imagined: 1) The design workflow is adapted to only work with predefined components. While this might be a suitable approach for industrialised building projects, designers might feel limited due to this approach for innovative project or architectural competitions. 2) The calculation of the embodied impact is adapted to use simplified approaches based on surface areas instead of volumetric models. This approach has proven to be beneficial in early design stages, but is slightly less accurate for certification of the as-built model. 3) LCA tools learn from previous projects (machine learning) and automatically use typical assumptions

for the placeholder materials in early design stages. This approach requires a large database of as-built BIM models with the required information for LCA that does not exist yet. In collaboration with researchers, sustainability certification institutes and commercial LCA tools such a database could be established and used in a long-term perspective.

## Acknowledgements

We would like to thank Basler&Hofmann for providing the case study and supporting this research.

This research did not receive any specific grant from funding agencies in the public, commercial, or not-for-profit sectors.

## References

- [1] UN Environment, IEA, 2018 Global Status Report: towards a zero-emission, efficient and resilient buildings and construction sector, Available at International Energy Agency and the United Nations Environment Programme, [https://www.worldgbc.org/sites/default/files/2018GlobalABC Global Status Report.pdf](https://www.worldgbc.org/sites/default/files/2018GlobalABC%20Global%20Status%20Report.pdf), (2018), Accessed date: 7 July 2019.
- [2] IRP, *The Weight of Cities: Resource Requirements of Future Urbanization. A Report by the International Resource Panel*, United Nations Environment Programme, Nairobi, Kenya, 2018.
- [3] H. König, M.L. De Cristofaro, Benchmarks for life cycle costs and life cycle assessment of residential buildings, *Building Research & Information* 40 (2012) 558–580 <https://doi.org/10.1080/09613218.2012.702017>.
- [4] German Sustainable Building Council, DGNB system, Available at German Sustainable Building Council, <http://www.dgnb-system.de/en/>, (2015), Accessed date: 7 August 2019.
- [5] ISO 14040, Environmental management-life cycle assessment-principles and framework, Available at International Organization for Standardization, <https://www.iso.org/standard/38498.html>, (2006), Accessed date: 7 July 2019.
- [6] ISO 14044, Environmental management-life cycle assessment-requirements and guidelines, Available at International Organization for Standardization, <https://www.iso.org/standard/37456.html>, (2006), Accessed date: 7 July 2019.
- [7] S. Lasvaux, J. Gantner, Towards a new generation of building LCA tools adapted to the building design process and to the user needs? Proceedings of SB13 Graz on Construction Products and Technologies. Graz, 2013, pp. 406–417, <https://doi.org/10.3217/978-3-85125-301-6>.
- [8] I. Zabalza Bribián, A. Aranda Usón, S. Scarpellini, Life cycle assessment in buildings: state-of-the-art and simplified LCA methodology as a complement for building certification, *Build. Environ.* 44 (2009) 2510–2520 <https://doi.org/10.1016/j.buildenv.2009.05.001>.
- [9] J. Diaz, L. Antón, Sustainable construction approach through integration of LCA and BIM tools, The Sixth Annual International Conference on Computing in Civil and Building Engineering, 2014, pp. 455–462 <https://doi.org/10.1061/9780784413616.053>.
- [10] A. Hollberg, J. Ruth, LCA in architectural design—a parametric approach, *Int. J. Life Cycle Assess.* 21 (2016) 943–960 <https://doi.org/10.1007/s11367-016-1065-1>.
- [11] B. Wittstock, S. Albrecht, C. Makishi Colodel, J.P. Lindner, G. Hauser, K. Sedlbauer, Gebäude aus Lebenszyklusperspektive – Ökobilanzen im Bauwesen (buildings from a life cycle perspective – life cycle assessment in the building sector), *Bauphysik* 31 (2009) 9–17, <https://doi.org/10.1002/bapi.200910003>.
- [12] U. Bogenstätter, Prediction and optimization of life-cycle costs in early design, *Building Research & Information* 28 (2000) 376–386 <https://doi.org/10.1080/096132100418528>.
- [13] B. Soust-Verdaguer, C. Llatas, A. García-Martínez, Critical review of BIM-based LCA method to buildings, *Energy and Buildings* 136 (2017) 110–120 <https://doi.org/10.1016/j.enbuild.2016.12.009>.
- [14] C. Bueno, M.M. Fabricio, Comparative analysis between a complete LCA study and results from a BIM-LCA plug-in, *Autom. Constr.* 90 (2018) 188–200 <https://doi.org/10.1016/j.autcon.2018.02.028>.
- [15] C. Cavalliere, BIM-led LCA: feasibility of improving life cycle assessment through building information modelling during the building design process, Available at Politecnico di Bari, <https://iris.poliba.it/handle/11589/160002>, (2018), Accessed date: 7 July 2019.
- [16] A. Stadel, J. Eboli, A. Ryberg, J. Mitchell, S. Spatarì, Intelligent sustainable design: integration of carbon accounting and building information modeling, *J. Prof. Issues Eng. Educ. Pract.* 137 (2011) 51–54 [https://doi.org/10.1061/\(ASCE\)EI.1943-5541.0000053](https://doi.org/10.1061/(ASCE)EI.1943-5541.0000053).
- [17] Crippa, J., Boeing, L.C., Caparelli, A.P.A., da Costa, M. do R. de M.M., Scheer, S., Araujo, A.M.F., Bem, D., 2018. A BIM–LCA integration technique to embodied carbon estimation applied on wall systems in Brazil. *Built Environment Project and Asset Management* 8, 491–503. <https://doi.org/10.1108/BEPAM-10-2017-0093>.
- [18] B. Soust-Verdaguer, C. Llatas, A. García-Martínez, J.C. Gómez de Cózar, BIM-based LCA method to analyze envelope alternatives of single-family houses: case study in Uruguay, *J. Archit. Eng.* 24 (2018), [https://doi.org/10.1061/\(ASCE\)AE.1943-5568.0000303](https://doi.org/10.1061/(ASCE)AE.1943-5568.0000303).
- [19] C. Bueno, L.M. Pereira, M.M. Fabricio, Life cycle assessment and environmental-based choices at the early design stages: an application using building information

- modelling, *Architectural Engineering and Design Management* 0 (2018) 1–15 <https://doi.org/10.1080/17452007.2018.1458593>.
- [20] M. Röck, A. Hollberg, G. Habert, A. Passer, LCA and BIM: visualization of environmental potentials in building construction at early design stages, *Build. Environ.* 140 (2018) 153–161, <https://doi.org/10.1016/j.buildenv.2018.05.006> (<https://www.sciencedirect.com/science/article/abs/pii/S036013231830266X?via%3Dihub>).
- [21] F. Shadram, T.D. Johansson, W. Lu, J. Schade, T. Olofsson, An integrated BIM-based framework for minimizing embodied energy during building design, *Energy and Buildings* 128 (2016) 592–604 <https://doi.org/10.1016/j.enbuild.2016.07.007>.
- [22] M. Tsikos, K. Negendahl, Sustainable design with respect to LCA using parametric design and BIM tools, *World Sustainable Built Environment Conference, 2017* Available at [http://orbit.dtu.dk/files/133787517/Sustainable\\_Design\\_with\\_Respect\\_to\\_LCA\\_Using\\_Parametric\\_Design\\_and\\_BIM\\_Tools.pdf](http://orbit.dtu.dk/files/133787517/Sustainable_Design_with_Respect_to_LCA_Using_Parametric_Design_and_BIM_Tools.pdf), Accessed date: 7 August 2019.
- [23] C. Cavalliere, G. Habert, G.R. Dell'Osso, A. Hollberg, Continuous BIM-based assessment of embodied environmental impacts throughout the design process, *J. Clean. Prod.* 211 (2019) 941–952 <https://doi.org/10.1016/j.jclepro.2018.11.247>.
- [24] E. Meex, A. Hollberg, E. Knapen, L. Hildebrand, G. Verbeeck, Requirements for applying LCA-based environmental impact assessment tools in the early stages of building design, *Build. Environ.* 133 (2018), <https://doi.org/10.1016/j.buildenv.2018.02.016>.
- [25] J. Gantner, P. von Both, K. Rexroth, S. Ebertshäuser, R. Horn, O. Jorgji, C. Schmid, M. Fischer, Ökobilanz - integration in den Entwurfsprozess (life cycle assessment – integration in the design process), *Bauphysik* 40 (2018) 286–297 <https://doi.org/10.1002/bapi.201800016>.
- [26] KBOB, Ökobilanzdaten im Baubereich 2009/1:2016 (LCA data for the construction sector), Available at [https://www.kbob.admin.ch/kbob/de/home/publikationen/nachhaltiges-bauen/okobilanzdaten\\_baubereich.html](https://www.kbob.admin.ch/kbob/de/home/publikationen/nachhaltiges-bauen/okobilanzdaten_baubereich.html), (2016), Accessed date: 7 August 2019.
- [27] CEN, EN 15978: sustainability of construction works - assessment of environmental performance of buildings - calculation method, Available at European Committee for Standardization, <https://shop.bsigroup.com/ProductDetail?pid=00000000030256638>, (2011), Accessed date: 7 August 2019.
- [28] R. Frischknecht, S. Büsser Knöpfel, Ökofaktoren Schweiz 2013 gemäss der Methode der ökologischen Knappheit - Methodische Grundlagen und Anwendung auf die Schweiz (Ecofactors Switzerland 2013 according to the method of ecological scarcity – methodological background and application to Switzerland), Available at <https://www.bafu.admin.ch/bafu/de/home/themen/wirtschaft-konsum/publikationen-studien/publikationen/okofaktoren-2015-knappheit.html>, (2013), Accessed date: 7 August 2019.
- [29] SIA, SIA 2032 Graue Energie von Gebäuden (embodied energy of buildings), Available at Schweizerischer Ingenieur- und Architektenverein, <http://shop.sia.ch/normenwerk/architekt/sia2032/d/D/Product>, (2010), Accessed date: 7 August 2019.
- [30] J. Quelle-Dreuning, MPG-grenswaarde een feit! (MPG Limit Value a Fact!), *Duurzaam Gebouwd*, 2017, pp. 66–67. Available at <https://www.duurzaamgebouwd.nl/magazine/duurzaam-gebouwd-magazine-36-1>, Accessed date: 7 August 2019.
- [31] Bionova, OneClick LCA model checker, Available at <https://www.oneclicklca.com/bim-for-sustainable-building-design-with-one-click-lca-model-checker/>, (2019), Accessed date: 7 August 2019.
- [32] R. Santos, A.A. Costa, J.D. Silvestre, L. Pyl, Integration of LCA and LCC analysis within a BIM-based environment, *Autom. Constr.* 103 (2019) 127–149 <https://doi.org/10.1016/j.autcon.2019.02.011>.
- [33] Hawkins\Brown, Hawkins\Brown: emission reduction tool, Available at <https://www.hawkinsbrown.com/services/hbert>, (2018), Accessed date: 7 August 2019.
- [34] S. Lee, S. Tae, S. Roh, T. Kim, Green template for life cycle assessment of buildings based on building information modeling: focus on embodied environmental impact, *Sustainability* 7 (2015) 16498–16512 <https://doi.org/10.3390/su71215830>.
- [35] C.F. Dunant, P. Drewniak, S. Eleftheriadis, J.M. Cullen, J.M. Allwood, Resources, conservation & recycling regularity and optimisation practice in steel structural frames in real design cases, *Resour. Conserv. Recycl.* 134 (2018) 294–302 <https://doi.org/10.1016/j.resconrec.2018.01.009>.
- [36] N. Čuš-Babič, D. Rebolj, M. Nekrep-Perc, P. Podbreznik, Supply-chain transparency within industrialized construction projects, *Comput. Ind.* 65 (2014) 345–353 <https://doi.org/10.1016/j.compind.2013.12.003>.
- [37] Y. Teng, C. Mao, G. Liu, X. Wang, Analysis of stakeholder relationships in the industry chain of industrialized building in China, *J. Clean. Prod.* 152 (2017) 387–398 <https://doi.org/10.1016/j.jclepro.2017.03.094>.
- [38] X. Zhao, W. Pan, W. Lu, Business model innovation for delivering zero carbon buildings, *Sustain. Cities Soc.* 27 (2016) 253–262 <https://doi.org/10.1016/j.scs.2016.03.013>.
- [39] F. Kedir, D. Hall, Assessing the environmental implications of industrialized housing: a systematic literature review, *Modular and Offsite Construction (MOC) Summit Proceedings. Banff, 2019*, pp. 314–324 <https://doi.org/10.29173/mocs109>.
- [40] CAALA GmbH, Computer-Aided Architectural Life cycle Assessment (CAALA), Available at [www.caala.de](http://www.caala.de), (2018), Accessed date: 7 August 2019.
- [41] A. Farzaneh, D. Monfet, D. Forgues, Review of using building information modeling for building energy modeling during the design process, *Journal of Building Engineering* 23 (2019) 127–135 <https://doi.org/10.1016/j.job.2019.01.029>.
- [42] H. Gao, C. Koch, Y. Wu, Building information modelling based building energy modelling: a review, *Appl. Energy* 238 (2019) 320–343 <https://doi.org/10.1016/j.apenergy.2019.01.032>.
- [43] A. Andriamonjy, D. Saelens, R. Klein, An automated IFC-based workflow for building energy performance simulation with Modelica, *Autom. Constr.* 91 (2018) 166–181 <https://doi.org/10.1016/j.autcon.2018.03.019>.
- [44] Y. Arayici, T. Fernando, V. Munoz, M. Bassanino, Interoperability specification development for integrated BIM use in performance based design, *Autom. Constr.* 85 (2018) 167–181 <https://doi.org/10.1016/j.autcon.2017.10.018>.
- [45] A. Hollberg, A parametric method for building design optimization based on life cycle assessment, *Bauhaus University Weimar*, <https://doi.org/10.25643/bauhaus-universitaet.3800>, (2016).
- [46] A. Hollberg, T. Lützkendorf, G. Habert, Top-down or bottom-up? – how environmental benchmarks can support the design process, *Build. Environ.* 153 (2019) 148–157 <https://doi.org/10.1016/j.buildenv.2019.02.026>.
- [47] P. Tecchio, J. Gregory, R. Ghattas, R. Kirchain, Structured under-specification of life cycle impact assessment data for building assemblies, *J. Ind. Ecol.* 0 (2018) 1–16 <https://doi.org/10.1111/jiec.12746>.
- [48] F. Rezaei, C. Bulle, P. Lesage, Integrating building information modeling and life cycle assessment in the early and detailed building design stages, *Build. Environ.* 153 (2019) 158–167 <https://doi.org/10.1016/j.buildenv.2019.01.034>.
- [49] T. Bloch, R. Sacks, Comparing machine learning and rule-based inferencing for semantic enrichment of BIM models, *Autom. Constr.* 91 (2018) 256–272 <https://doi.org/10.1016/j.autcon.2018.03.018>.
- [50] H. Naganathan, W.O. Chong, X. Chen, Building energy modeling (BEM) using clustering algorithms and semi-supervised machine learning approaches, *Autom. Constr.* 72 (2016) 187–194 <https://doi.org/10.1016/j.autcon.2016.08.002>.
- [51] L. Wei, W. Tian, E.A. Silva, R. Choudhary, Q. Meng, S. Yang, Comparative study on machine learning for urban building energy analysis, *Procedia Engineering* 121 (2015) 285–292 <https://doi.org/10.1016/j.proeng.2015.08.1070>.
- [52] A. Frömel, Data Mining Meets Life Cycle Assessment: Towards Understanding and Quantifying Environmental Impacts of Individual Households, *ETH Zürich*, 2018, <https://doi.org/10.3929/ethz-b-000282689>.
- [53] J. Hester, J. Gregory, F.J. Ulm, R. Kirchain, Building design-space exploration through quasi-optimization of life cycle impacts and costs, *Build. Environ.* 144 (2018) 34–44 <https://doi.org/10.1016/j.buildenv.2018.08.003>.
- [54] H.M. Chen, K.C. Chang, T.H. Lin, A cloud-based system framework for performing online viewing, storage, and analysis on big data of massive BIMs, *Autom. Constr.* 71 (2016) 34–48 <https://doi.org/10.1016/j.autcon.2016.03.002>.
- [55] F. Schlegl, J. Gantner, R. Traunspurger, S. Albrecht, P. Leistner, LCA of buildings in Germany: proposal for a future benchmark based on existing databases, *Energy and Buildings* 194 (2019) 342–350 <https://doi.org/10.1016/j.enbuild.2019.04.038>.