



Methodology for Testing Rebar-Concrete Bond in Specimens from Decommissioned Structures

Downloaded from: <https://research.chalmers.se>, 2026-04-05 00:40 UTC

Citation for the original published paper (version of record):

Lundgren, K., Robuschi, S., Zandi, K. (2019). Methodology for Testing Rebar-Concrete Bond in Specimens from Decommissioned Structures. *International Journal of Concrete Structures and Materials*, 13(1). <http://dx.doi.org/10.1186/s40069-019-0350-3>

N.B. When citing this work, cite the original published paper.

RESEARCH

Open Access



Methodology for Testing Rebar-Concrete Bond in Specimens from Decommissioned Structures

Karin Lundgren^{*} , Samanta Robuschi and Kamyab Zandi

Abstract

Mimicking natural deterioration in accelerated tests is challenging; a highly relevant alternative option is to use deteriorated specimens from decommissioned structures. This paper describes a methodology to select and design tests of the bond and anchorage between reinforcement and concrete in such specimens, with the aim of providing general information, needed when developing methods for assessing structures in general. The methodology includes the following steps: (1) choice of existing structure for samples, (2) choice of test method, (3) design of test setup, and (4) design of test programme. Each step is discussed in detail and comments are made on considerations and challenges arising specifically due to the use of specimens from existing structures. As the scatter of test results is typically large, a suitable test method should enable a large number of tests by being robust, quick and affordable. It is recommended to keep track of the position of the specimens in the original structure, to document cracks, and to take samples also of uncorroded bars. These can then be used for reference in quantifying the corrosion level of corroded bars. This methodology is exemplified in the design of three test series on edge beams from two bridges; two series resulted in beam test setups and one in direct pull-out tests. The methodology described strongly highlights that careful investigations are required to design experiments which generate reliable data. Acquiring data from decommissioned structures will improve our understanding of the structural behaviour of existing structures and thus enable improved assessment methods.

Keywords: bond, concrete, reinforcement, experiments, existing structures, corrosion

1 Introduction

Existing structures represent enormous investment. Accordingly, their deterioration poses a major challenge and is receiving greater attention. Corroded steel reinforcement is the most common cause of deterioration in reinforced concrete (Bell 2004) and is often combined with other deterioration mechanisms, such as freezing–thawing cycles. Wang (Wang et al. 2010) analysed the impacts of climate change and showed that the deterioration of concrete structures is anticipated to worsen. Moreover, the demand for load-carrying capacity (such as bridges) often intensifies over time as traffic loads

increase. Thus, there is a growing need for reliable methods of assessing the load-carrying capacity of existing, deteriorated structures. Corroding reinforcement affects the structure in two ways: (1) volume expansion that may crack and spall the concrete cover, affecting the bond between reinforcement and concrete, and (2) area reduction and ductility changes in the reinforcement bars. Both reduce the safety of the structure, so it is important to understand and control them. This paper focuses on the bond between reinforcement and concrete.

Existing bond models of corroded reinforcement have been developed based on experiments on artificially corroded specimens. However, deterioration by natural corrosion does not have the same effects on structural behaviour as deterioration from artificial corrosion. Experimental evidence found in the literature shows that

*Correspondence: karin.lundgren@chalmers.se
Department of Architecture and Civil Engineering, Chalmers University of Technology, 412 96 Göteborg, Sweden
Journal information: ISSN 1976-0485 / eISSN 2234-1315

common methods of accelerated induced corrosion (such as admixed chloride, impressed current and wet/drying techniques) may change the morphology of the corrosion products to differing extents (Vera et al. 2009). Probably, the most influential factor is the corrosion rate (Andrade et al. 2002). Another study shows the electrochemistry in naturally induced corrosion differs from accelerated corrosion (Austin et al. 2004). Further, the structural effects are not the same. Saifullah and Clark (1994) showed spurious bond deterioration for specimens subjected to high impressed currents. Another study pointed out the corrosion rate as one of the important parameters influencing the results in bond tests (Sæther 2011). Reducing the time from years to days is strong justification for using accelerated induced corrosion in lab tests. However, great care should be taken when interpreting results and extrapolating them to field conditions.

It is common to study the influence of one deterioration mechanism at a time; however, several recent investigations point at a strong interaction between corrosion and freeze–thaw cycles (Kuosa et al. 2014; Zhang et al. 2017). To conclude, the most realistic conditions are achieved when using specimens from decommissioned structures. However, only a few test series have been conducted investigating the bond in naturally deteriorated specimens. Horrigmoe et al. (2007) used cubic specimens with a corroded bar inside, from Ullasund Bridge in Norway. However, before testing, the specimens have been cast in new concrete. This provided additional confinement and thus no corrosion effects on the bond were observed in the test results. Edge beams from Stallbacka Bridge in Sweden were tested by two of the authors in four-point bending, studying the effect of corrosion on the end anchorage in two test series, (Lundgren et al. 2015a; Tahershamsi et al. 2014). Furthermore, in ongoing but unpublished work, specimens from a bridge in Gullspång in Sweden were tested. This paper compiles the lessons learned from working on this topic. It structures them into a methodology for selecting and designing tests of bond and anchorage between reinforcement and concrete, using specimens from decommissioned structures. Each step in the process (especially the variety of possible test methods) is discussed in detail and recommendations made. Finally, the methodology is exemplified in design of three test series, including ribbed and smooth bars.

2 Methodology

The methodology suggested in this paper, for designing tests of the bond and anchorage between reinforcement and concrete in specimens from existing structures, includes the following steps:

1. Choice of existing structure for sampling.
2. Choice of test method.
3. Design of test setup.
4. Design of test programme.

The procedure is iterative (often the case with design), such that results from a later step may influence an earlier step. Each step is discussed in detail in the following sections. Finally, there are some comments and notes on the special considerations and challenges relating to the use of specimens from existing structures.

2.1 Choice of Existing Structure for Samples

There are two possible situations in which samples are taken from an existing structure: (1) tests to provide input for assessing the structure in question and (2) a search for more general information, needed when developing models and methods for assessing structures in general. In the second case, the structure (or part of it) is most likely decommissioned. This paper focuses on the second case. Well-established connections between researchers and infrastructure owners/managers are vital when it comes to finding specimens from naturally deteriorated structures for research tests. Opportunities often arise at relatively short notice and matching the necessary research funding can be a challenge. In our experience, this is best handled via ongoing active dialogue. The following aspects should be considered when considering different opportunities:

- Permission to take specimens. This may be due to demolition or closure of an entire structure for major repairs (such as replacing edge beams on bridges).
- Depending on the focus of the intended research the following should be considered relevant: age, cement and concrete type, rebar type and layout, amount of transverse reinforcement, exposure, main deterioration mechanisms and so on.
- Available information on the structure, such as detailed drawings, previous material tests, and so on.
- Requirement for a large number of similar specimens with varying corrosion levels, from uncorroded parts, to intermediate corrosion causing longitudinal splitting cracks, to spalling of concrete cover due to severe corrosion.
- The geometry of the specimens should suit either a bending test of a beam resulting in anchorage failure, or a pull-out test of bond response.
- Specimens should be easily accessible, for inspection before removal and for cutting and handling.

In our work so far, we have taken edge beams from bridges. However, we have considered several other

possibilities. Edge beams are a good choice as they are easy to access and, in the case of long bridges, a large number of specimens can be obtained. Further, they are frequently replaced, as the average service life for edge beams on European roads in Sweden is currently only 30–40 years (Veganzones Muñoz et al. 2016). Piles supporting harbour quays have potential suitability as test objects. During reconstruction, a large number of specimens may be available and their marine environment is highly relevant. One example of structures considered but not chosen was deteriorated columns in a parking garage. These might have been valuable to study but could not be exchanged in a way that allowed specimens to be taken.

2.2 Choice of Test Method

2.2.1 General Requirements and Overview of Possible Test Setups

The next step is to choose a test method. Important requirements include the ability to:

- Study the anchorage failure for specimens at various levels of corrosion damage, in a single test setup.
- Capture anchorage failure without disturbing the natural damage to specimens.
- Carry out a large number of tests, because the scatter of test results are expected to be large. Thus, it is preferable to have a test setup which is robust, quick and affordable to prepare and carry out.
- Clearly define boundary conditions, making it easier to compare experimental results with, say, finite element analyses.

Several test setups are commonly used in the literature to test bond and anchorage. These can be divided into different groups: pull-out tests, beam-end tests and beam tests. An overview is shown in Table 1 and each setup is discussed in detail in the following sections.

2.2.2 Pull-Out Tests

Pull-out tests are a simple and an inexpensive way to test local bond behaviour. However, they have two main disadvantages: (1) unlike real situations, the concrete is compressed while the bar is under tension, and (2) due to friction at the bearing end, they have greater resistance to splitting than is common in real situations (Cairns and Plizzari 2003). These samples can still provide useful information, if their disadvantages are considered during evaluation, e.g. through combination with 3D finite element analyses as in Lundgren (2005).

Relatively short embedment lengths are commonly used, e.g. 5 times the bar diameter (RILEM/CEB/FIP 1978), allowing the bond stress to be assumed constant.

This simplifies evaluation and also implies smaller specimens. However, the end effect, the so-called “cone failure” (consisting of local cracking of concrete near the loaded end radiating about 45° from the bar), influences the evaluated bond stress. This effect becomes more pronounced for shorter embedment lengths (Cairns and Plizzari 2003). When specimens are produced in laboratory for pull-out tests, this problem is commonly avoided by having a bond-free zone close to the pulling action (Lundgren 2000; Lin et al. 2017). However, this is not viable for specimens taken from existing structures; this limits the accuracy of the bonded zone’s length. Still, this effect can be taken into account by documenting the cracking at the end zone after the tests. Thus, the embedment length of the tests can be stated as rather well-defined.

When pull-out specimens are produced in the laboratory, the bar is simply left protruding. This is not so easy to do for specimens from existing structures, as they are typically cut from a larger structure. There is a risk of damaging the bond if the concrete is removed by, say, hydrodemolition. Thus, pull-out tests include the challenge of grabbing the bars. For single bars, this can be done by drilling into and tapping the bar, then inserting a threaded rod. This was tried in the example described in Sect. 3.2.2. For bundled bars, pulling several bars in the bundle with the same deformation appears more complex. However, this challenge is also true of specimens cast with protruding bars.

One way to avoid the problem of grabbing the bar may be to use indirect pull-out tests. This means drilling a core through the whole specimen, applying tensile loading and clamping onto the other side, as indicated in the figure in Table 1. To the authors’ knowledge, this test setup has not been tried. It has the potential benefit that the force in the bars can be calculated with reasonable accuracy. However, there is a risk of asymmetry which can cause bending and rotation. Furthermore, the clamping can be difficult to manage and somewhat major modifications to the specimens are required.

2.2.3 Beam-End Test

ACI Committee 408 (2003) states that splice and beam-end specimens best replicate the stress state in concrete when testing the bond capacity of flexural members. A major advantage is that each bar can be loaded individually and the forces in the bars measured directly. Like the pull-out test, the beam-end test involves the difficulty of gripping the reinforcement bars. However, this can be overcome in a manner similar to that described for pull-out tests.

Furthermore, the beam-end test has well-defined available anchorage length and represents the

Table 1 Overview of possible test setups.

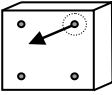
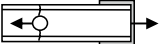
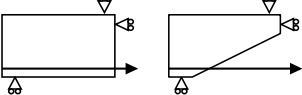
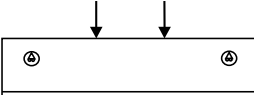
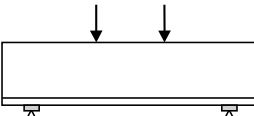
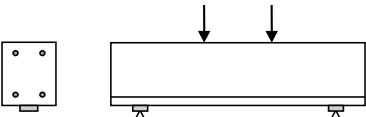
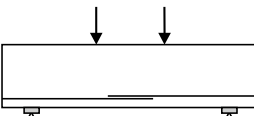
Test setup	Advantages	Disadvantages
Direct pull-out 	Simple test setup Force in the bar is known Well-defined embedment length, unless a cone failure occurs	Compressed concrete while the bar is in tension Friction at the bearing end Cone failure near the loaded end needs to be considered when evaluating results Challenge of grabbing bars
Indirect pull-out 	Force in the bars can be calculated with reasonable accuracy	Risk of asymmetry can cause bending and rotation Clamping can be difficult to manage Specimens need a lot of modifications
Beam-end 	Forces in bars are known Well-defined embedment length, unless inclined cracking occurs	Challenge of grabbing bars Bond capacity or embedment length needs to be small enough to avoid bars yielding Effect of support pressure
Beam tests, general (<i>all advantages and disadvantages hold for all sub-groups of beam tests</i>)	Relevant as they closely approximate real application Gripping of bars is avoided	Requires thorough design to obtain anchorage failure instead of other failure modes. E.g. choice of three or four-point bending, spans etc. For symmetrical test setups, the side that will fail is not known in advance, which increases need for instrumentation Forces in bars need to be calculated
Beam test, suspended supports 	Experience exists, (Lundgren et al. 2015a; Tahershamsi et al. 2014) Specimens with spalled concrete cover can be tested	Likely requires strengthening to withstand hanging support reactions Relatively complicated setup Inclined shear cracks will interact with spalling cracks. Thus, the available anchorage length might not be well-defined
Beam test, direct support 	Simple and straightforward Available anchorage length rather well-defined. Inclined shear cracks expected towards direct supports	Effect of support pressure Support area may need repair
Beam test, narrow direct support 	Simple and straightforward Limits the effect of support pressure	Risk of tilting Balancing the anchored force may entail having a stirrup just outside the support area Support area may need repair
Beams with spliced reinforcement 	Simple and straightforward Relevant, as they closely approximate real application	Can be difficult to locate splices, or splices may not be suitably positioned

structural behaviour better than in the pull-out test. Two possible test specimens may be considered, with straight or inclined surfaces (from the horizontal support to the tensile reinforcement bars), see figure in Table 1. The specimen with a straight cut is easier to produce from existing specimens. However, the risks of inclined cracking or rupture of the reinforcement bars

need to be considered. The specimen with an inclined surface benefits from a better-defined available anchorage length, as it avoids inclined cracking (Chana 1990; Zandi et al. 2011). However, complicated cutting is required for specimens taken from real structures. To the authors' knowledge, no such tests have been conducted on specimens from existing structures.

Another challenge with beam-end tests is the support pressure acting on the anchorage zone, which substantially increases the anchorage capacity (Magnusson 2000). Beam-end specimens are therefore commonly produced with a bond-free zone above the support (Zandi et al. 2011). However, this is not easy to accomplish for specimens from existing structures and seems almost impossible without disturbing the bonded zone. There is further discussion regarding the supports in the next section (regarding beam tests). The challenges and possible solutions are very largely similar for beam-end tests.

2.2.4 Beam Tests

Designing beam tests to investigate bond and anchorage can be challenging, as anchorage failure is often combined with other failure modes, such as shear, crushing of concrete, or yielding of bars. Thus, the choice of spans and test setup (in the form of three or four-point bending, for example) can be adjusted to obtain the intended failure mode. Furthermore, for symmetrical test setups, the side that will fail is not known in advance, which increases the need for instrumentation. These challenges hold for all sub-groups of beam tests. On the other hand, beam tests are relevant as they closely approximate real application. As with beam-end tests, when new specimens are produced, it is common to have bond-free zones above the supports. This avoids support pressure in the anchorage zone, as recommended in RILEM (1970). However, as with beam-end tests, this seems impossible to accomplish for specimens taken from existing structures without disturbing the bonded zone. Various ways to handle the support pressure are discussed in the following, concluding with beams with spliced reinforcement.

2.2.4.1 Beam Tests with Indirect Supports, Testing End Anchorage Without Support Pressure One way to avoid support pressure is to have beams indirectly supported by suspension hangers, see example in Sect. 3.1 or (Lundgren et al. 2015a; Tahershamsi et al. 2014) for more details. A major advantage is that parts with spalled cover can be left as they are. However, a disadvantage of the test-setup is that it will likely require the specimens to be strengthened to withstand hanging support reactions. Furthermore, inclined shear cracks will interact with spalling cracks. Thus, it can be difficult to clearly define the available anchorage length.

2.2.4.2 Beam Tests with Direct Supports, Testing End Anchorage with Support Pressure Directly supported beam tests will likely result in well-defined available anchorage length, because inclined shear cracks often

propagate to the edge of a direct support. However, the support pressure will influence the anchorage behaviour considerably. With external transverse pressure acting in the anchorage region, bond stiffness and strength both increase (Lundgren and Magnusson 2001). The major influence of corrosion on bond is a reduction in confinement due to cracking and eventually spalling. It is therefore inappropriate to use a test setup which compensates for this, because support pressure is not always present in real anchorage situations (in, say, splices or cut-off regions). Finally, for severely damaged members with cover spalling, a test configuration with direct supports is not possible without repairing the specimens to get a flat surface for the supports. However, a repair is not a proper solution, as it greatly influences the anchorage capacity.

2.2.4.3 Beam Tests with Narrow Direct Supports, Testing End Anchorage with Limited Support Pressure To limit the effect of support pressure, narrow supports between the reinforcement bars can be used, see figure in Table 1. Thus, direct support pressure on the anchored bars is avoided, but the beams can still be directly supported. This affords the benefits of easier test execution with no need for strengthening, making the test setup simple and straightforward. Still, to avoid a bursting failure, it is important for the anchored force to be balanced by a stirrup just outside the support, towards the free end of the beam. This requirement for a stirrup just outside the support restricts where stirrups can be placed in the remainder of the beam. It is often preferable to have at least one stirrup in the shear span. However, depending on stirrup spacing and planned shear span, it may not be possible to combine these. Furthermore, if narrow supports are to be used on both sides, the need for stirrups just outside each support will set certain requirements for the chosen spans. It may not be possible to keep the spans constant between different beams. Finally, the use of narrow supports entails a risk of tilting which needs to be considered and the support areas may need repair.

2.2.4.4 Beams with Spliced Reinforcement, Testing Anchorage of Bars in Splines Test setups involving beams with spliced reinforcement are highly relevant. Such tests are relatively simple and straightforward to carry out, because the beams can be directly supported. The main challenge is finding specimens with splines at suitable positions, or locating the splines at all.

2.3 Test Setup Design

Even for early-stage estimates, there is a need for material data and sensitivity studies on its influence. Generally, some basic material information is available from drawings and sometimes from previous material tests

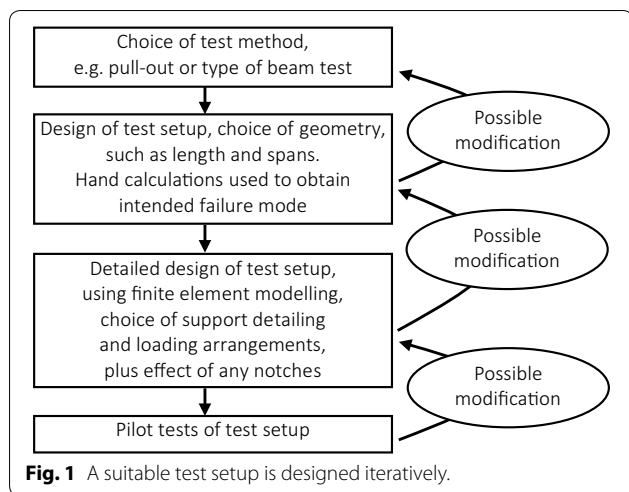

too. If certain material data is found to be important in controlling the type of failure mode, then ideally it should be characterised in material tests before determining the final test setup.

Once the test method is chosen, the test setup is designed iteratively, see Fig. 1. Suitable measures of geometry (such as length and spans) are first estimated using hand calculations. The main aim is to find suitable loading arrangements which will likely result in the intended failure mode. As the main parameters of the specimens are given (such as specimen dimensions, reinforcement layout and so on), the process is typically rather different than would be the case when designing new test specimens. Thus, with stricter boundaries regarding available specimens, a greater degree of creativity is required (in terms of investigating which parameters may be chosen).

After completing the initial test setup design (using a geometrical configuration which hand calculations indicate would result in the anticipated failure mode), ideally nonlinear finite element (FE) analyses are conducted to further study the influence of various parameters. Alongside varying length and spans, FE analyses also allow the details of support and loading arrangements and the effect of any notches to be studied. Finally, it is strongly recommended that pilot tests be conducted before the full test programme is planned and executed.

2.4 Design of Test Programme

A well-designed test programme includes tests for various types of anticipated damage. Commonly, the specimens are categorised based on visible damage. In our experience (especially in the test series described

in Sect. 3.1), it is preferable to keep the categorisation simple. Thus, having few groups with clear distinctions is preferable to having many groups. This will naturally cause some scatter within each damage group. However, in our experience, as the specimens will be dissimilar anyway, the simplicity of categorisation and larger number of specimens in each group will be beneficial.

Furthermore, due to the large variation in test specimens and stochastic nature of corrosion (plus the variation in bond, even for sound specimens designed and produced to be similar), a large number of specimens in each category is needed. If possible, a minimum of six specimens in each category is therefore recommended.

2.5 Special Considerations and Challenges

Notes are given below on the particular considerations needed and challenges arising from the use of specimens from existing structures.

- Documenting cracks in specimens (such as crack locations, patterns and widths) is strongly recommended. This needs to be done both on site and in the laboratory before testing. Crack location can be documented using crack IDs, giving crack locations relative to the structural member, crack patterns using photographs and crack widths at several locations along a crack using a crack width gauge/ruler or microscope. More advanced tools can also be helpful (such as laser scanning of an entire test object).
- It is important to keep track of the position of the specimens in the original structure, to later understand damage patterns due to differing exposure to sun, wind, salt, and so on. Colour marks tend to wash out with time, even when permanent colour is used. Specimens should therefore be piled up in a consistent manner whenever stored.
- Investigate the availability of information about historical development of damage, in inspection documents for example.
- Ensure specimens are treated with caution during transport, storage and handling. Specimens will often need to be stored before testing and their environment during this time will have an influence. In particular, if specimens are taken from a structure which has been outside for a number of years, it may be wise not to bring them indoors for some time. The drier indoor climate may dry out the concrete, causing substantial opening of existing cracks.
- The structure will often be cut into larger pieces at the site. Before cutting these into test specimens, the exact position of the reinforcement needs to be known (especially splices, hooks and stirrups), plus the position of any cast joints, so that cutting can be

planned. Original drawings are often unreliable when it concerns exact reinforcement positions. Visual inspection can be combined with non-destructive inspection methods such as radar scan detection systems. These allow rebars to be located in relatively thick concrete (up to about 30 cm). However, large quantities of steel or thick concrete parts can compromise the accuracy of such methods. A simple test setup and accurate post-testing inspection can minimise the influence of geometrical uncertainties on the final outcomes.

- After structural testing, the bars are brought out to quantify their level of damage. It is often a major challenge to quantify their corrosion level, as the bar weight prior to casting is typically unknown. It is therefore recommended to sample uncorroded bars and use these as reference. Furthermore, sandblasting is recommended for rust removal, as it was proved being an optimal cleaning method for naturally corroded bars when compared to metallic brushing and acid immersion (Fernandez et al. 2018). After sandblasting (using a cleaning procedure following the ASTM (2011) recommendations), the corrosion level is quantified using gravimetric method or 3D optical scanning technique (Tahershamsi et al. 2017).

3 Examples of Designed Test Series

The design of three test series are described below.

3.1 Example with Ribbed Bars

The first example concerns specimens from Stallbacka Bridge, located outside Trollhättan in Sweden. The bridge was built in 1981, with the outermost slabs and edge beams replaced between 2010 and 2012 (at an age of about 30 years). The edge beams were chosen for research because they were naturally corroded and had different levels of corrosion-induced damage, from no sign of corrosion to extensive cover cracking resulting in spalling of the concrete cover. The edge beams were longitudinally and transversally reinforced with ribbed bars. The tests and their results were reported in (Lundgren et al. 2015a; Tahershamsi et al. 2014, 2017). The considerations in designing the test programme are described below.

The edge beams contained main reinforcement in bundles of two, see Fig. 2. It was therefore considered very difficult to grab a bar, or bundle, for direct pull-out. However, the geometry of the edge beams was suitable for bending tests. This allowed evaluation of the anchorage behaviour at a structural level and so beam tests were chosen. Suspended supports were chosen

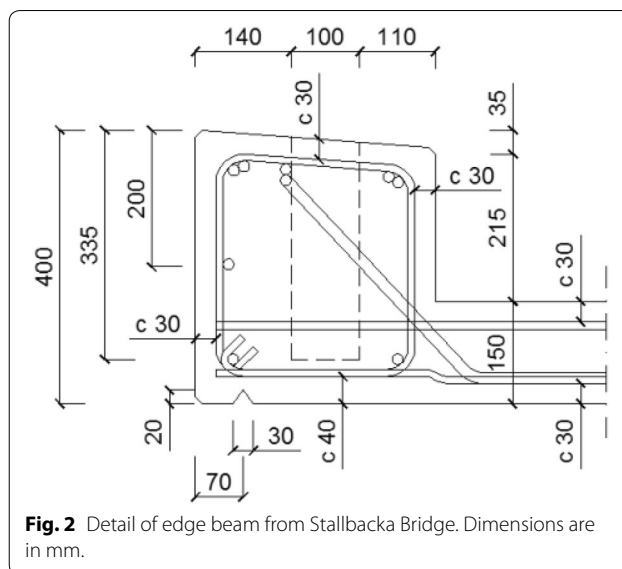

instead of direct supports, for two main reasons: (1) to avoid support pressure, and (2) the upper surface of the edge beams was inclined and had more spalling damage than the lower surface. This was probably due to more exposure to de-icing salts during its service life. The upper bars were therefore deemed of more value to the investigation of bond and anchorage behaviour. However, having a direct support applied to these bars would have involved supporting an inclined surface. This was deemed unsuitable.

Based on these considerations, a beam test setup with suspended supports was chosen. It was regarded this would cause the least disturbance to the natural damage to the edge beams, whilst capturing the structural behaviour. A four-point-bending test setup was chosen, based on hand calculations.

The four-point-bending test, indirectly supported with suspension hangers, was designed in detail to ensure anchorage failure. This was done in a parametric study using non-linear finite element method, briefly described below. For more details, see Berg and Johansson (2011). Various parameters were investigated: the location of the suspension hole, the position of the concentrated loads and the influence of any notches. Regarding the shear capacity, it was considered important to place the load so that its path crossed at least one stirrup. The reinforcement's material properties were chosen based on test results for similar bars. The concrete strength used was the one given in original drawings.

In an extensive parametric study, the shear failure or local failure of the suspension seemed critical, independent of the test settings. It was therefore concluded that

the beams needed additional transverse reinforcement. Internal mounting was considered the most promising option. In this method, vertical holes are drilled and reinforcing bars are bonded. The number of reinforcing steel bars, their location, dimension and steel quality was determined by running a number of analyses until the risk of the reinforcing steel yielding was minimised.

Pilot tests were conducted, based on the results of the parameter study. The first pilot test was conducted on a specimen with some corrosion cracking but no cover spalling. The beam was strengthened with 4 ϕ 16 B500B at each suspension hole, bonded to the concrete with epoxy. However, this test resulted in a local failure at the suspension hole, due to insufficient anchorage of the strengthening bars. The transmission length between the critical crack, (initiating from the suspension hole and propagating to the adjacent concentrated load and free end) was too short.

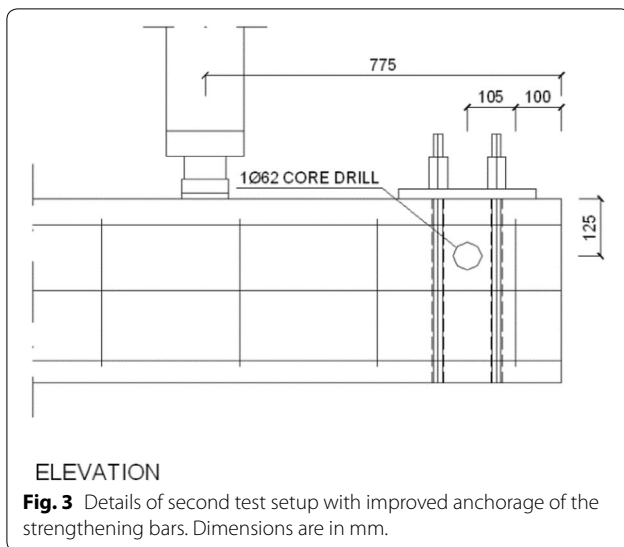

The experience gained from the first test led to a modification of the strengthening, shown in Fig. 3. Strengthening bars (DYWIDAG) of prestressing steel of 20 mm diameter were used. The high-yield, fully threaded steel reinforcing bars were anchored at the top of the beam with nuts and flat steel plates. The bars were bonded to the concrete with epoxy. This was also applied between the flat steel plate and concrete beam, to obtain even pressure.

Two beams with the improved strengthening method were tested, one almost undamaged and one with severe corrosion damage including cover spalling. They were selected to investigate whether the developed test method will result in anchorage failure for all corrosion levels of interest. These pilot tests succeeded well, both resulting in anchorage failure as intended. Upon loading, the first cracks were flexural-type and occurred between the two concentrated loads. With increased load, flexural and inclined shear cracks developed in the shear spans. When the cracks propagated towards the supports, the anchorage became critical. In other words, failure occurred (as intended) due to insufficient anchorage of the tensile reinforcement. Photos of the crack patterns after the tests are shown in Fig. 4.

Following the successful pilot tests, two test series were conducted using the test setup that had been developed. The main reason for having two series was that the bridge was being repaired one side at a time. We therefore had the opportunity to take specimens from the second side about a year after the first. The specimens were categorised into three groups, based on the initial visible damage: (1) Reference, no visible damage, (2) Medium, with spalling cracks and (3) Highly damaged, with cover spalling. We had initially planned for more categories, depending on the width of the spalling crack. Thus, the Medium category was originally divided into



Fig. 4 Pilot tests with improved strengthening method at the suspension holes. Left: specimen without initial damage, after structural testing. Right: specimen with initial corrosion damage including cover spalling, upon failure.

more groups. However, this proved too complicated, (a) because it had to be decided whether the largest spalling crack determined the category regardless of crack length and (b) because the crack width increased when specimens were brought inside and exposed to dry air.

The first series examined two Reference, three Medium, and three Highly damaged specimens (Lundgren et al. 2015a). The largest scatter was in Medium; we realised that the main interest lies in this category. The Reference category was needed for comparison, while specimens categorised under Highly damaged would probably need repair anyhow. However, the Medium category can provide useful information on where the limits lie. For that reason, several more Medium specimens were included in the second test series. This one included two Reference, eight Medium, and three Highly damaged specimens (Tahershamsi et al. 2014). Some minor modifications to the slip measurement were made between first and second series, but essentially, the same test setup was used.

All tests resulted in splitting-induced pull-out failure. The Medium and Highly damaged specimens showed around 6 and 9% lower load-carrying capacity, respectively, in comparison with the undamaged specimens. The average bond stress along the bundled bars was calculated from the applied load, the circumference of the bundled bars, and the available anchorage length; the latter was evaluated based on the crack pattern and was measured from the point where the main bars and the inclined shear crack intersect to the end cross section; for details see (Lundgren et al. 2015b). The calculated

average bond stress in the anchorage zone was about 20% lower in the beams with corrosion cracks compared with the Reference specimens, whereas it was 12% lower in the beams with cover spalling. Thus, even though the Highly damaged specimens had the lowest capacity, the Medium damaged specimens had the lowest evaluated bond capacity. This was because the Highly damaged specimens had in general shorter available anchorage length; probably because they were prone to crack closer to the edge due to the pre-existing damages.

The results were compared to others in literature with artificially induced corrosion; all with rebars of 16 mm diameter: (Berra et al. 1997; Rodriguez et al. 1994; Fang et al. 2004; Zandi et al. 2011; Fischer and Ozbolt 2013). It was observed that for the same crack widths, the specimens with natural corrosion had slightly higher bond capacity compared to other studies found in literature with artificially induced corrosion, see Fig. 5. On the other hand, for the same corrosion level, it was the opposite; i.e. the specimens with natural corrosion had slightly lower bond capacity compared to most other studies found in literature with artificially induced corrosion, see Fig. 6. These conclusions may seem contradictory, but are due to that for the same crack widths, the specimens in this study had much less corrosion level compared to other studies found in literature with artificially induced corrosion. This is most likely due to different effects of artificial corrosion and natural deterioration including corrosion taking place over a very long period, combined with e.g. freezing–thawing.

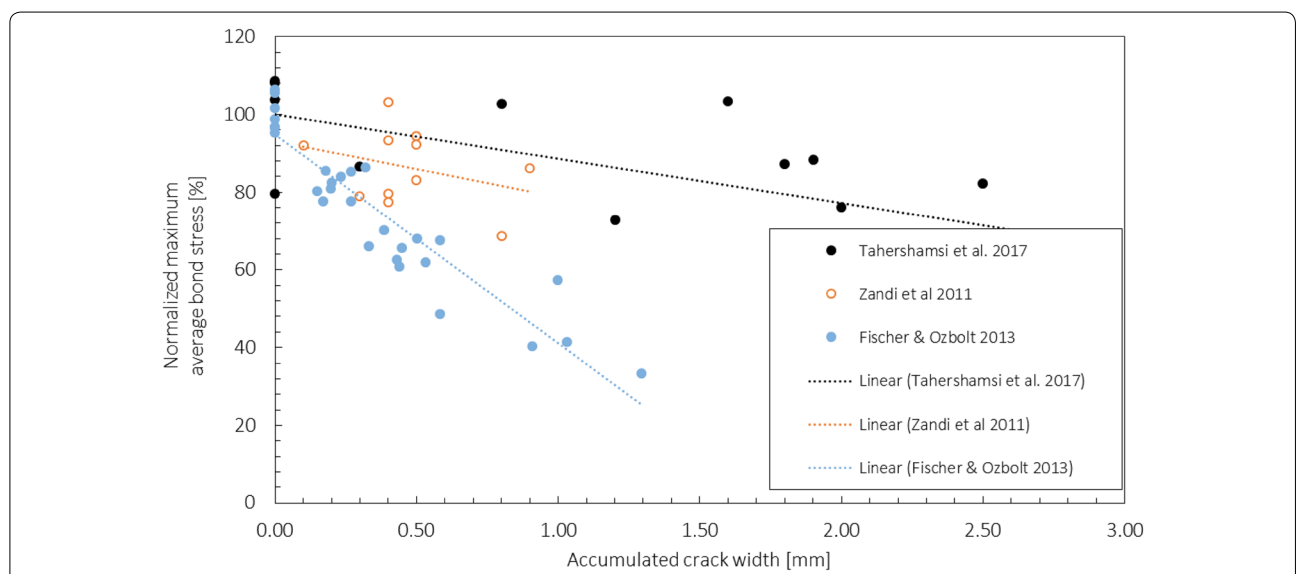

Fig. 5 Comparison between test results from naturally corroded specimens and results from artificially corroded tests in terms of bond strength, normalized with respect to the average maximum bond strength obtained from reference samples, versus maximum crack width of splitting cracks.

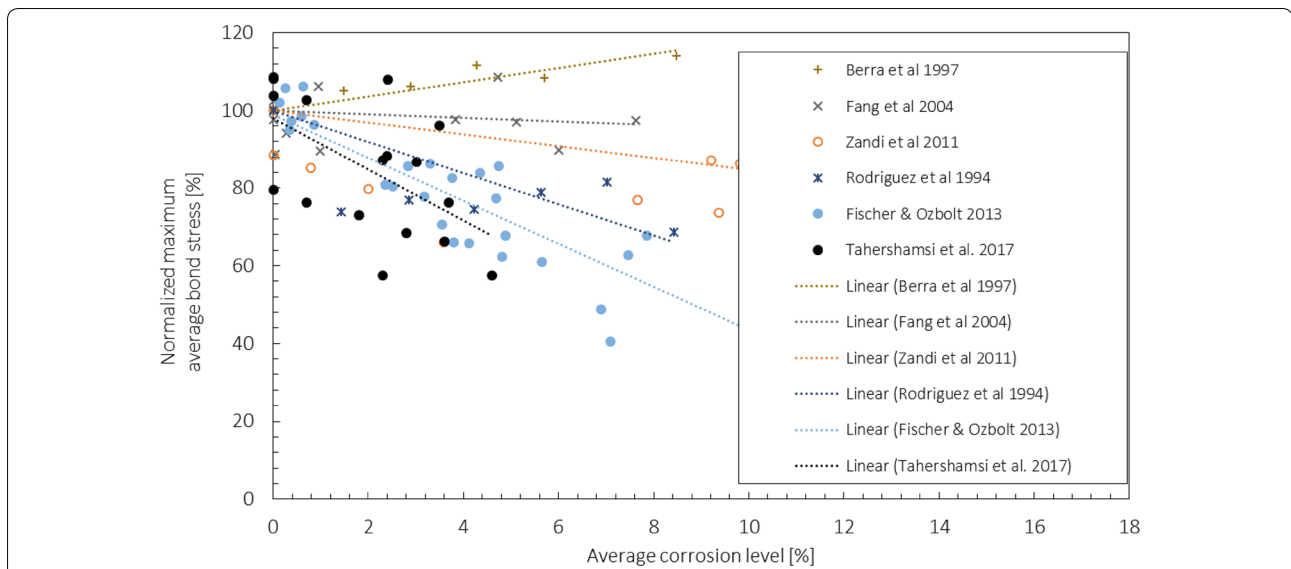

Fig. 6 Bond strength normalized with respect to the average bond strength obtained from reference samples versus average corrosion levels. Comparison between test results from naturally corroded specimens and results from artificially corroded tests from literature.

3.2 Example with Smooth Bars

The second example aimed at studying the anchorage capacity of naturally corroded smooth reinforcement bars. Naturally corroded specimens were obtained from Gullspång Bridge, Sweden, which was built in 1935 and torn down in 2016 due to heavy corrosion. The edge beams were chosen for research for the following reasons: (1) very limited data on smooth bars is found in the literature, even though many existing structures contain smooth bars, (2) the geometric and material properties are typical of structures of similar age and (3) they have long been exposed to weather conditions (including rain, snow, freezing–thawing cycles, wind, de-icing salts and traffic loads), resulting in varied natural corrosion of the bars.

The dimensions of the edge beams in the original drawings are shown in Fig. 7. However, the actual geometry varied in several respects. In particular, the actual stir-rup spacing and concrete cover showed major variability. The material properties were affected by the aging of the

structure and so the specification in the original drawings could not be fully trusted. In a field survey conducted in 1988, the concrete compressive strength was measured at 45 MPa and the yield strength of the smooth reinforcement bars was 252 MPa.

3.2.1 Beam Tests

The general requirements stated in Sect. 2.2.1 were applied when choosing test setups. It was also considered important for the setup to allow for testing bottom as well as top-cast bars, as the casting position strongly influences the bond of smooth bars. Top-cast bars are more likely to be surrounded by less dense concrete, which reduces the bond capacity. Visual inspection of the specimens made it clear that indirectly supported beam setups could not be used (although this would have been desirable to avoid support pressure). The specimens were considered too deteriorated, with extensive spalling and cracking. Drilling large holes would have risked the specimens falling to pieces.

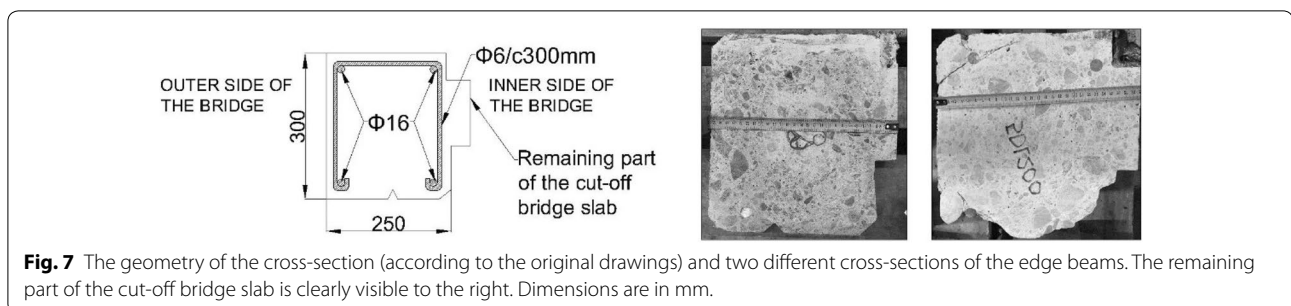
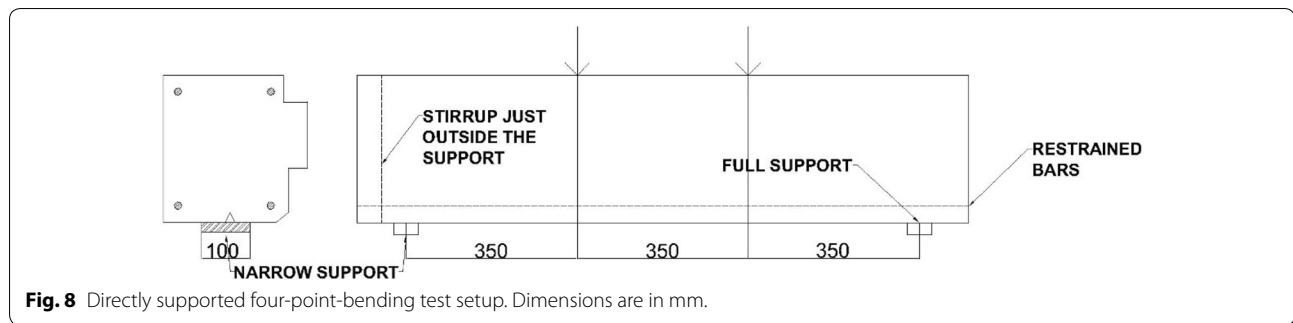

Fig. 7 The geometry of the cross-section (according to the original drawings) and two different cross-sections of the edge beams. The remaining part of the cut-off bridge slab is clearly visible to the right. Dimensions are in mm.



The next test setup considered was therefore a directly supported four-point-bending beam test (Fig. 8). To directly support the beam while minimising support pressure on the reinforcement bars, a narrow support was introduced. This was positioned in between the bars on one side of the beam where anchorage failure was expected. The specimen was designed to have a stirrup (external to the narrow support) to help redistribute the more highly concentrated, support-generated stresses. On the other side, where a full-width support was used, the bar ends were restrained by washers and bolts, to avoid end slips. The aim was to design a test setup which could achieve anchorage failure when a major shear crack opened. Nonlinear 3D FE analysis was adopted as a tool to investigate the crack pattern (Robuschi et al. 2018). In these analyses, the bond-slip relationship was assumed to be constant along the entire bar, with a maximum bond stress of 1–7 MPa in different analyses. From the results, it was noted that rebar yielding followed shortly after bending cracks appeared. Furthermore, the low bond capacity [which, according to literature, is likely for smooth bars (Cairns et al. 2006)], low reinforcement ratio (0.54%) and low reinforcement yield strength, made it difficult for the beam to redistribute stresses once the first bending cracks opened. Thus, no shear crack was observed in the analyses; only bending cracks, either beneath the loading plates or at mid-span. Finally, the

opening order and positioning of bending cracks cannot be predicted, as they depend on variations in the material and the beams' geometrical properties. Thus, this test setup risks a bending crack far from the end of the specimen and thus a long available anchorage length. Still, as the assumed bond capacity carried a high degree of uncertainty, it was considered possible for a four-point-bending test setup to work in practice.

As the four-point-bending test setup included the risks described above, a second test setup was considered, allowing a shorter anchorage length and better defined crack pattern. It involved a directly supported, three-point-bending beam test, with the same asymmetric support conditions (narrow/full) as the first alternative (Fig. 9). By removing the constant bending-moment span, a single bending crack was likely to occur beneath the load plate. Hand calculations and FE analyses were again used to choose the shear span and investigate the crack pattern.

Based on the results of these analyses, three pilot tests were carried out:

- Test 1 was an asymmetrically supported three-point-bending test (Fig. 9), with bars restrained on one side, tested upside-down in respect to its original position on the bridge. This resulted in anchorage failure. As predicted, a major bending crack opened, followed

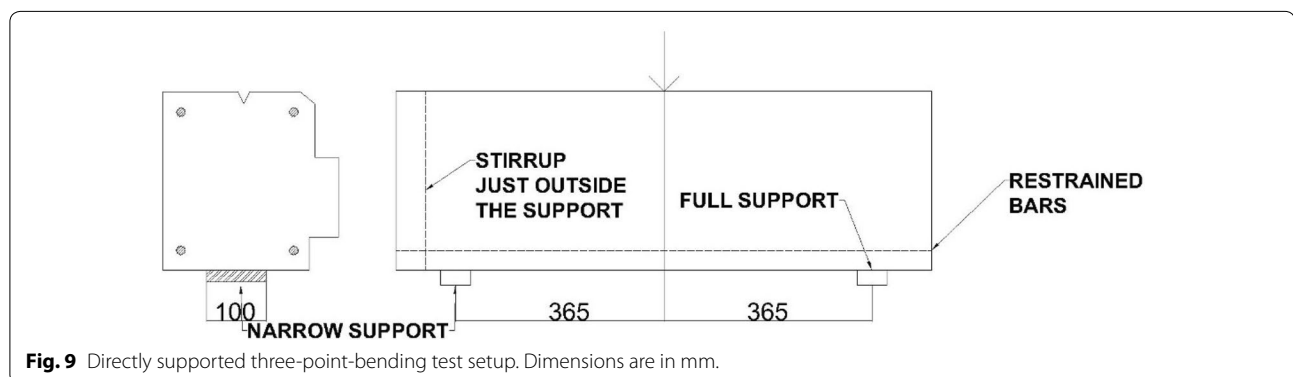

by yielding of the bars and eventual slippage of the bars on the narrow support side, one at a time.

- Test 2 was an asymmetrically supported four-point-bending test, with bars restrained on the side with full support, tested upside-down in respect to its position on the bridge. This presented signs of anchorage failure on the restrained side. Cracks were localised to three different locations, underneath each load plate and at mid-span. However, only the crack at mid-span and the one close to the full support continued to open (the latter located at a cast joint). Opening of these two cracks was followed by yielding and, at greater deflection, failure of the beam on the full-support side (where slippage of the restrained bars bent the washers). Thus, it was concluded that restraining the bars on one side would likely lead to a high percentage of tests with restraint failure. For this reason, in the third test, the choice was made not to use restraints on the side with full support, but to monitor slips on both sides.
- Test 3 was an asymmetrically supported four-point-bending test (Fig. 8). This had no bars restrained and was tested as positioned on the bridge, resulting in anchorage failure on the full-support side. This test was characterised by the development of two cracks underneath the load plates. The use of digital image correlation made it possible to observe a third-strain concentration zone in the mid-span, but a visual inspection did not show any crack. Yielding of the bars followed, with the bars on the full-support side eventually starting to slip one at a time.

Some of the outcomes of the pilot tests were well predicted by the FE analysis:

- In all three tests, the reinforcement bars started yielding shortly after the first bending crack opened. It was evident that a beam test of these specimens would have to include the effect of yielding on anchorage capacity.
- No shear crack opened in any of the tests. It was concluded that the properties of the edge beams did not allow for design of a test setup where a shear crack would define the bars' anchorage length.

In addition, the pilot tests showed that:

- Restraining the bars on the full-support side did not prevent anchorage failure when the anchorage length was significantly smaller on that side (as in the Test 2).
- Full support does not increase the bar confinement enough to prevent anchorage failure on the full-support side, when the bars are not restrained (as in Test 3).

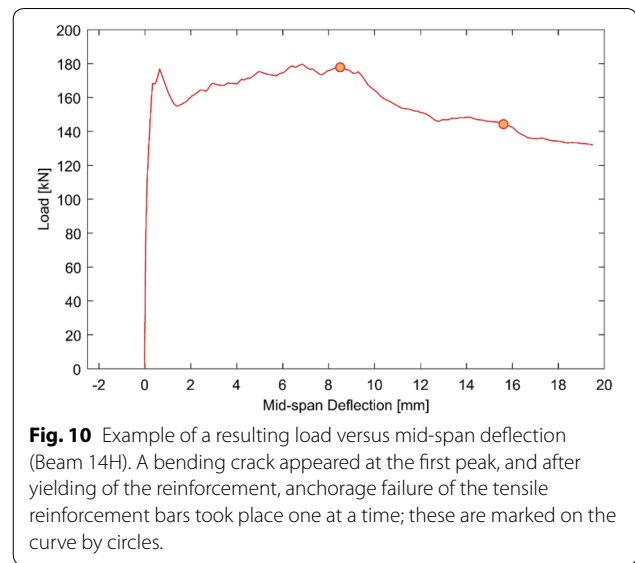

Fig. 10 Example of a resulting load versus mid-span deflection (Beam 14H). A bending crack appeared at the first peak, and after yielding of the reinforcement, anchorage failure of the tensile reinforcement bars took place one at a time; these are marked on the curve by circles.

Based on these results, the final test setup was designed as an asymmetrically and directly supported three-point-bending test. This type of test was considered a safer choice due to its more predictable crack pattern. The restraints on the full-support side were excluded, to avoid the risk of restraint failure in multiple tests. A large test series (20 beam tests) was successfully carried out. The tests were characterized by the opening of one or two bending cracks, followed by yielding of the tensile reinforcements. Slippage of the reinforcement took place, one bar at a time, at higher level of mid span deflection (see Fig. 10). After the three-point-bending tests, the rebars were brought out, 3D-scanned to characterise the corrosion level and yield penetration and then tested in tension. The anchorage capacity of the unyielded parts was evaluated based on these results.

3.2.2 Pull-Out Tests

The previous section demonstrated that beam tests on specimens from Gullspång Bridge could not, by themselves, offer a full understanding of the bond capacity of smooth bars when affected by corrosion. Data on the local bond-slip (when unaffected by yielding of reinforcement bars) is particularly necessary to fully characterise the bond. The influence of support pressure, moreover, needed to be investigated. Therefore, an additional test programme was designed to allow for comparison.

Considering the alternatives described in Sect. 2.2, a direct pull-out test was chosen. This was because it has the advantage of being relatively quick and simple to carry out, with a known force in the bar. Thus, the edge beam was cut into slices, as shown in the examples in Fig. 7. The challenge of grabbing the bars was solved by

drilling into the rebars, tapping them and attaching a threaded rod. For this test series, the only analysis made beforehand involved choosing a sufficiently short embedment length to avoid the bar yielding. In the first pilot tests, an embedment length of about 50 mm was chosen. Thus, a 50 mm slice of the edge beam was cut.

Subsequent development of the test method was by trial and error. In the first pilot tests, the aim was to try a really simple test setup and gain some initial knowledge before designing something more suitable. A circular support plate was applied to the concrete surface, with a hole centred at the rebar. Thus, the threaded rod attached to the bar protruded through the support plate and was loaded using a cylindrical hydraulic jack. The tests highlighted the challenge of ensuring that the load was in exactly the same direction as the bar. The edge beam was not cut at an exact 90° angle to the beam edges and, even when it was, the positioning of the bar was not perfectly aligned with the edge. In the first pilot tests, therefore, rather large and at times asymmetrical cone failure appeared on the active side. It was thus found to be of the utmost importance that the bar is pulled out as straight as possible. All skew angles between bar and cut concrete surface need to be handled properly. Furthermore, in the first pilot tests, we only measured the slip on the passive side. However, it was deemed important to obtain reliable slip measurements on the active side too.

A special rig was therefore designed and produced, see Fig. 11. This consisted of three legs, two of which

could be length-adjusted to account for any skew angle between bar and cut concrete surface. Three displacement transducers were fitted inside the rig, measuring the relative displacement between the rod and the steel plate surface. This provided a reliable measurement of active slip. The passive slip was also measured by gluing a small displacement transducer to the free bar end and measuring relative to the concrete surface. Furthermore, a method to ensure straight drilling into the bars was developed: a small indent was drilled at the centre of both the active and passive sides of the bar and a rig, positioning the drill in line with the two indents with screws, was used at drilling. Upon testing, the rod screwed into the bar on the active side was used to assure alignment of test rig and bar.

This test methodology ensured straight pulling-out of the bar and made it possible to obtain stable measurements of load and passive and active slip. Cone failure was still observed in some of the tests, but with dimensions of only a few millimetres. Thus, the effect on embedment length could be considered negligible.

A major test programme was designed. The specimens included varying deterioration levels, and top and bottom-cast bars. It was also decided to vary the embedment length to distinct values and divide the specimens into groups. Yielding of bars was to be avoided. Combined with the results of the pilot tests, this gave an upper limit of 100 mm embedment length. The lower limit was set to 50 mm, for feasible cutting of



Fig. 11 Pull-out test setup, (left) in pilot test and (right) with developed rig.

concrete slices and drilling (20 mm deep) not to affect the major part of the length. Based on these arguments, embedment lengths of 50, 75, and 100 mm were chosen. A large scatter in test results was expected and, as this setup made tests quick and affordable, a large number of each combination was chosen. There was a total of 174 bars, of which 104 were in concrete without visible damage, 35 had cracks, and 35 had some spalling of the concrete cover. After the pull-out tests, the bars were 3D-scanned to characterise their corrosion level.

3.2.3 Comparison Between Beam Tests and Pull-Out Tests

In Fig. 12, an overview of the bond strength results for bottom-cast bars obtained with the two described test methodologies is presented. It can be seen that for low levels of corrosion, bond strength from beam tests are higher than those obtained from pull-out tests. This could possibly be due to the support pressure in the beam test setup. For higher levels of corrosion, there is no major difference between the results. To conclude, two different test setups were developed and employed for the evaluation of the bond strength of smooth bars subjected to corrosion damages. Even though the results indicate that the presence of external confinement from direct supports in the beam tests should be taken into account for a better evaluation, the two different testing methods show reasonably good agreement.

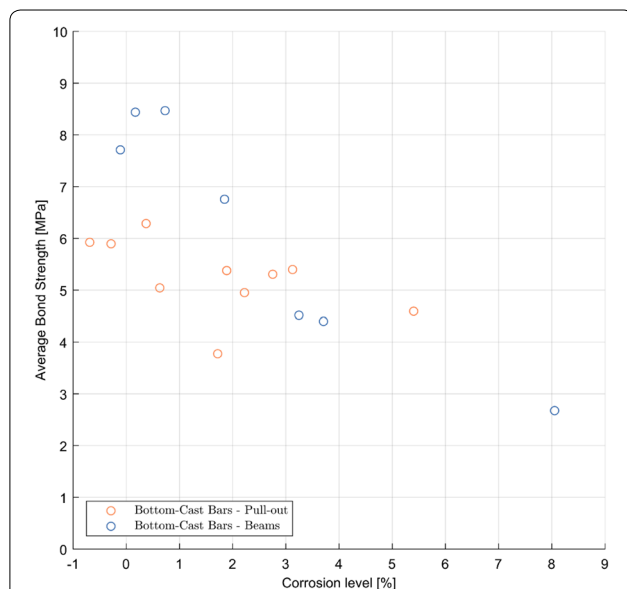

Fig. 12 Average bond strength and corresponding average corrosion level of bottom cast bars. Each point in the graph represents the bond strength of the tested bars averaged over an interval of 0.5% of corrosion.

4 Conclusions

A methodology to select specimens and design experiments to test bond and anchorage between reinforcement and concrete in specimens taken from decommissioned structures was described and discussed. This methodology included the following steps:

1. Choice of existing structure for sampling.
2. Different options and requirements were discussed and it was concluded that edge beams from bridges are suitable as they are often available and easy to access. A large number of specimens with varying corrosion levels can also be obtained.
3. Choice of test method.
4. A suitable test method should be robust, quick and affordable to prepare and carry out. This allows a large number of tests, which is preferred as the scatter in results is expected to be large. Furthermore, the test method should result in anchorage failure in specimens with various corrosion damage levels in a single, common test setup. Different possible test methods and associated advantages and disadvantages were discussed in detail.
5. Design of test setup.
6. A suitable test setup is designed iteratively. First, preliminary geometry is estimated using hand calculations. Thereafter, it is recommended that nonlinear, finite element analyses be conducted to further study parameter effects, detailing of support and loading arrangements. Finally, it is strongly recommended that pilot tests be conducted before a full test programme is planned and carried out.
7. Design of test programme.
8. A test programme should contain tests of various levels of expected damage. We recommend dividing the tests into a small number of categories with straightforward categorisation. A large number of specimens is needed in each category.

Other general recommendations are to keep track of the position of specimens in the original structure and document cracks in them. In other words, crack locations, patterns and widths. Furthermore, a major challenge is often quantifying the corrosion level of corroded bars, as their weight before casting is typically unknown. It is therefore recommended that samples are taken from uncorroded bars, for use as reference.

Examples of test series designs included specimens from two bridges. In the first example, the specimens were 30 year-old edge beams with ribbed reinforcement in bundles of two bars. A test programme was designed for these including four-point-bending tests, indirectly supported with suspension hangers. Anchorage failure

after inclined shear cracking was studied, and compared to results from literature with accelerated corrosion. The second example included 80 year-old edge beams with smooth reinforcement bars. Two test programmes were designed for these. The first had three-point-bending tests with a narrow direct support on one side and full-width support on the other. In these, the structural behaviour and anchorage failure after yielding of bars were studied. A second test programme of direct pull-out tests was developed, to get more data on the local bond-slip without yielding of reinforcement bars. The main challenge was ensuring the load had exactly the same direction as the bar. A method of securing straight drilling into the bars and a special loading rig were developed and used. This could be adjusted to account for any skew angle between bar and cut concrete surface. A quick and reliable test method of local bond-slip behaviour was thus obtained. The results from the two different test setups developed and employed for smooth bars indicate that even though the presence of external confinement from direct supports in the beam tests should be taken into account for a better evaluation, the two different testing methods show reasonably good agreement.

The above methodology strongly highlights how existing structures need to be carefully investigated and understood, if experiments are to be designed that will generate reliable data. Standard test setups need adapting to the given geometrical and material properties. On the other hand, the extra effort is repaid by the capability to investigate the corrosion effects resulting from natural exposure conditions; something which cannot be replicated in a laboratory environment. Acquiring data from decommissioned structures will improve our understanding of how existing structures behave and thus allow improved assessment methods.

Acknowledgements

The authors wish to acknowledge the contribution from all colleagues and students who have been involved in the experimental series.

Authors' contributions

KL led the planning and writing of the paper, suggested the main structure of the experimental methodology, and led the work for the experimental series. SR participated in the planning of the paper and also in the planning and execution of two of the three presented examples of experimental series. She contributed to the writing of the sections regarding those experiments, and with comments and discussions on the remaining paper. KZ participated in the planning of the paper, and contributed to the structure of the experimental methodology. He also participated in the planning and execution of the experimental series, and with comments and discussions on writing of the paper. All authors read and approved the final manuscript.

Funding

The work was funded by the Swedish research council Formas and the Swedish Transport Administration.

Availability of data and materials

Not applicable.

Competing interests

The authors declare that they have no competing interests.

Received: 11 March 2019 Accepted: 27 May 2019

Published online: 01 July 2019

References

- ACI Committee 408. (2003). *Bond and development of straight reinforcing bars in tension*. ACI 408R-03 Farmington Hills: American Concrete Institute.
- Andrade, C., Alonso, C., & Saría, J. (2002). Corrosion rate evolution in concrete structures exposed to the atmosphere. *Cement & Concrete Composites*, 24, 55–64. [https://doi.org/10.1016/S0958-9465\(01\)00026-9](https://doi.org/10.1016/S0958-9465(01)00026-9).
- ASTM. (2011). *Standard G1. Standard practice for preparing, cleaning, and evaluating corrosion test specimens*. West Conshohocken: ASTM.
- Austin, S. A., Lyons, R., & Ing, M. J. (2004). Electrochemical behavior of steel-reinforced concrete during accelerated corrosion testing. *Corrosion*, 60, 203–212. <https://doi.org/10.5006/1.3287722>.
- Bell B. (2004). Sustainable bridges. D1.3 European railway bridge problems.
- Berg F. and Johansson D. (2011). *Design of test set-up using FEM: Pilot tests on anchorage of naturally corroded reinforcement*. Master of Science Thesis, Civil and Environmental Engineering, Chalmers University of Technology, Gothenburg, 2011.
- Berra M., Castellani A. and Coronelli D. (1997). *Bond in reinforced concrete and corrosion of bars*. In seventh international conference on structural faults and repair.
- Cairns, J., Du, Y., & Law, D. (2006). Residual bond strength of corroded plain round bars. *Magazine of Concrete Research*, 58, 221–231. <https://doi.org/10.1680/mac.2006.58.4.221>.
- Cairns, J., & Plizzari, G. A. (2003). Towards a harmonised European bond test. *Materials and Structures/Materiaux et Constructions*, 36, 498–506. <https://doi.org/10.1617/13887>.
- Chana, P. S. (1990). A test method to establish realistic bond stresses. *Magazine of Concrete Research*, 42, 83–90.
- Fang, C., Lundgren, K., Chen, L., & Zhu, C. (2004). Corrosion influence on bond in reinforced concrete. *Cement and Concrete Research*, 34, 2159–2167.
- Fernandez, I., Lundgren, K., & Zandi, K. (2018). Evaluation of corrosion level of naturally corroded bars using different cleaning methods, computed tomography, and 3D optical scanning. *Materials and Structures/Materiaux et Constructions*. <https://doi.org/10.1617/s11527-018-1206-z>.
- Fischer, C. and Ožbolt J. (2013). An appropriate indicator for bond strength degradation due to reinforcement corrosion. In *Proceedings of the 8th international conference on fracture mechanics of concrete and concrete structures, FraMCoS 2013*, 2013.
- Horrigmoe G., Sæther I., Antonsen R. and Arntsen B. (2007). Sustainable bridges: Laboratory investigations of steel bar corrosion in concrete. Background document SB3.10. Norut Technology.
- Kuosa, H., Ferreira, R. M., Holt, E., Leivo, M., & Vesikari, E. (2014). Effect of coupled deterioration by freeze-thaw, carbonation and chlorides on concrete service life. *Cement & Concrete Composites*, 47, 32–40. <https://doi.org/10.1016/j.cemconcomp.2013.10.008>.
- Lin, H., Zhao, Y., Ožbolt, J., & Reinhardt, H. W. (2017). Bond strength evaluation of corroded steel bars via the surface crack width induced by reinforcement corrosion. *Engineering Structures*, 152, 506–522. <https://doi.org/10.1016/j.engstruct.2017.08.051>.
- Lundgren, K. (2000). Pull-out tests of steel-encased specimens subjected to reversed cyclic loading. *Materials and Structures*, 33, 450–456.
- Lundgren, K. (2005). Bond between ribbed bars and concrete. Part 1: Modified model. *Magazine of Concrete Research*, 57, 371–382. <https://doi.org/10.1680/mac.2005.57.7.371>.
- Lundgren, K., & Magnusson, J. (2001). Three-dimensional modelling of anchorage zones in reinforced concrete. *ASCE Journal of Engineering Mechanics*, 127, 693–699. [https://doi.org/10.1061/\(ASCE\)0733-9399\(2001\)127:7\(693\)](https://doi.org/10.1061/(ASCE)0733-9399(2001)127:7(693)).
- Lundgren, K., Tahershamsi, M., Zandi, K., & Plos, M. (2015a). Tests on anchorage of naturally corroded reinforcement in concrete. *Materials and Structures*, 48, 2009–2022. <https://doi.org/10.1617/s11527-014-0290-y>.
- Lundgren, K., Tahershamsi, M., Zandi, K., & Plos, M. (2015b). Tests on anchorage of naturally corroded reinforcement in concrete. *Materials and Structures/*

- Materiaux et Constructions*, 48, 2009–2022. <https://doi.org/10.1617/s11527-014-0290-y>.
- Magnusson J. (2000). *Bond and anchorage of ribbed bars in high-strength concrete*. Ph.D. Thesis, Division of Concrete Structures, Chalmers University of Technology, Göteborg, 2000.
- RILEM. (1970). Bond test for reinforcing steel—I. Beam test. *Materials and Structures*, 3, 169–174. <https://doi.org/10.1007/BF02478967>.
- RILEM/CEB/FIP. (1978). Bond test for reinforcing steel: 2. Pullout test, recommendation.
- Robuschi S., Lundgren K., Fernandez I., Zandi K. and Flansbjerg M. (2018). Anchorage capacity of corroded smooth reinforcement bars in existing reinforced structures. In *Proceedings of the 12th fib international Ph.D. symposium in civil engineering*, 2018.
- Rodriguez J., Ortega L. M. and Casal J. (1994). *Corrosion of reinforcing bars and service life of reinforced concrete structures: Corrosion and bond deterioration*. In International conference on bond across borders, Odense, Denmark.
- Sæther, I. (2011). Bond deterioration of corroded steel bars in concrete. *Structure and Infrastructure Engineering*, 7, 415–429. <https://doi.org/10.1080/15732470802674836>.
- Saifullah M. and Clark L. A. (1994). Effect of corrosion rate on the bond strength of corroded reinforcement. In *Proceedings of international conference: Corrosion and corrosion protection of steel in concrete*, University of Sheffield, 1994.
- Tahershamsi, M., Fernandez, I., Lundgren, K., & Zandi, K. (2017). Investigating correlations between crack width, corrosion level and anchorage capacity. *Structure and Infrastructure Engineering*, 13, 1294–1307. <https://doi.org/10.1080/15732479.2016.1263673>.
- Tahershamsi, M., Lundgren, K., Plos, M., & Zandi, K. (2014). Anchorage of naturally corroded bars in reinforced concrete structures. *Magazine of Concrete Research*, 66, 729–744. <https://doi.org/10.1680/mac.13.00276>.
- Veganzones Muñoz, J. J., Pettersson, L., Sundquist, H., & Karoumi, R. (2016). Life-cycle cost analysis as a tool in the developing process for new bridge edge beam solutions. *Structure and Infrastructure Engineering*, 12, 1185–1201. <https://doi.org/10.1080/15732479.2015.1095770>.
- Vera, R., Villarroel, M., Carvajal, A. M., Vera, E., & Ortiz, C. (2009). Corrosion products of reinforcement in concrete in marine and industrial environments. *Materials Chemistry and Physics*, 114, 467–474. <https://doi.org/10.1016/j.matchemphys.2008.09.063>.
- Wang, X., Nguyen, M., Stewart, M. G., Syme, M., & Leitch, A. (2010). *Analysis of climate change impacts on the deterioration of concrete infrastructure—synthesis report*. Canberra: CSIRO. ISBN 978-0-643-10364-1.
- Zandi, Hanjari K., Coronelli, D., & Lundgren, K. (2011). Bond capacity of severely corroded bars with corroded stirrups. *Magazine of Concrete Research*, 63, 953–968. <https://doi.org/10.1680/mac.10.00200>.
- Zhang, P., Cong, Y., Vogel, M., Liu, Z., Müller, H. S., Zhu, Y., et al. (2017). Steel reinforcement corrosion in concrete under combined actions: The role of freeze-thaw cycles, chloride ingress, and surface impregnation. *Construction and Building Materials*, 148, 113–121. <https://doi.org/10.1016/j.conbuilmat.2017.05.078>.

Publisher's Note

Springer Nature remains neutral with regard to jurisdictional claims in published maps and institutional affiliations.

Submit your manuscript to a SpringerOpen[®] journal and benefit from:

- Convenient online submission
- Rigorous peer review
- Open access: articles freely available online
- High visibility within the field
- Retaining the copyright to your article

Submit your next manuscript at ► [springeropen.com](https://www.springeropen.com)
