

THESIS FOR THE DEGREE OF DOCTOR OF PHILOSOPHY
IN THERMO AND FLUID DYNAMICS

Conceptual Design of Propulsion Systems for Boundary
Layer Ingestion

SEBASTIAN SAMUELSSON

Department of Mechanics and Maritime Sciences

CHALMERS UNIVERSITY OF TECHNOLOGY

Gothenburg, Sweden 2019

Conceptual Design of Propulsion Systems for Boundary Layer Ingestion
SEBASTIAN SAMUELSSON
ISBN 978-91-7905-193-8

© SEBASTIAN SAMUELSSON, 2019.

Doktorsavhandlingar vid Chalmers tekniska högskola
Ny serie nr 4660
ISSN 0346-718X

Department of Mechanics and Maritime Sciences
Chalmers University of Technology
SE-412 96 Gothenburg
Sweden
Telephone + 46 (0)31-772 1000

Chalmers Reproservice
Gothenburg, Sweden 2019

Conceptual Design of Propulsion Systems for Boundary Layer Ingestion
SEBASTIAN SAMUELSSON
Department of Mechanics and Maritime Sciences
Chalmers University of Technology

ABSTRACT

To reduce the climate impact of aviation new aircraft and engine concepts as well as improved design methods are needed. In this thesis, two fronts are explored. The first concerns improved methods for the conceptual design of the engine. A consistent conceptual design approach is presented, where calculated parameters such as stage loadings are used to update the component efficiency assumptions within the cycle optimization loop. The result is that the design space is fully explored, and that pressure ratio is optimally distributed between the components. A coupled analysis of a low pressure turbine and turbine rear structure has also been conducted, showing the importance of considering their coupled interaction when these components are designed.

On the second front, concerning the application of the developed methods to new propulsion applications, a conceptual design of a propulsion system for a turbo-electric boundary layer ingesting aircraft concept is presented. The aircraft features an aft-mounted fuselage fan for boundary layer ingestion. Earlier studies have shown a theoretical potential of 10% in power savings compared to a conventional aircraft configuration. The fuselage fan is electrically powered and fed by power offtake from two under-wing mounted geared turbofan engines. To this end, a 5 MW-class generator is integrated into the geared turbofans. The generator is connected to a free power turbine that is introduced to facilitate an optimal generator design and to mechanically decouple the generator from the low pressure shaft. A system-level analysis of the designed propulsion system, including the effects of the boundary layer ingesting fuselage fan shows a fuel burn reduction of 0.6%-3.6%, depending on electric machinery technology, compared to a conventional aircraft in the 2050 time frame. The modest reduction, compared to the theoretical potential, is caused by the difficulty of obtaining a benefit from ingesting the outer part of the boundary layer. This benefit is more than offset by electric machinery losses and the reduced efficiency of the fuselage fan compared to the main engine fan.

Keywords: Aviation, aircraft engine, conceptual design, performance modeling, propulsion integration, boundary layer ingestion, turbo-electric aircraft

LIST OF PUBLICATIONS

This thesis is based on the work contained in the following publications:

- Paper I** S. Samuelsson, K.G. Kyrianiadis and T. Grönstedt, 2015, "Consistent Conceptual Design and Performance Modeling of Aero Engines", *ASME Turbo Expo 2015, GT2015-43331, Montréal, Canada*
- Paper II** V. Raja, S. Samuelsson, O. Isaksson and T. Grönstedt, 2015, "Exploring Influence of Static Engine Component Design Variables on System Level Performance", *ISABE 2015, ISABE2015-20082, Phoenix, United States*
- Paper III** A. Seitz, F. Peter, J. Bijewitz, A. Habermann, Z. Goraj, M. Kowalski, A. Castillo Pardo, C. Hall, F. Meller, R. Merkler, O. Petit, S. Samuelsson, B. Della Corte, M. van Sluis, G. Wortmann and M. Dietz, 2018, "Concept Validation Study for Fuselage Wake-filling Propulsion Integration", *ICAS 2018, Belo Horizonte, Brazil*
- Paper IV** X. Zhao, V. Raja, S. Samuelsson, O. Isaksson, A. Lundbladh and T. Grönstedt, 2019, "Conceptual Mean-line Design of a Low Pressure Turbine for a Geared Turbofan with Rear Structure Interaction", *ISABE 2019, ISABE2019-24345, Canberra, Australia*
- Paper V** S. Samuelsson, O. Petit, R. Merkler and G. Wortmann, 2019, "Adaption of a Turbofan Engine for High Power Offtakes for a Turbo-electric Propulsive Fuselage Concept", *ISABE 2019, ISABE2019-24215, Canberra, Australia*
- Paper VI** R. Merkler, S. Samuelsson and G. Wortmann, 2019, "Integration Aspects for Large Generators into Turbofan Engines for a Turbo-electric Propulsive Fuselage Concept", *ISABE 2019, ISABE2019-24087, Canberra, Australia*
- Paper VII** S. Samuelsson and T. Grönstedt, 2019, "Performance Analysis of Turbo-electric Propulsion System with Boundary Layer Ingestion"
Submitted to Aerospace Science and Technology

ACKNOWLEDGMENTS

The work in Papers I, II and IV of this thesis has financially been supported by NFFP, the national aeronautical research programme, jointly funded by the Swedish Armed Forces, Swedish Defense Materiel Administration (FMV) and Swedish Governmental Agency for Innovation Systems (VINNOVA). The work contained in Papers III, V and VI has, as part of the CENTRELINE project, received funding from the European Union's Horizon 2020 research and innovation programme under Grant Agreement No. 723242.

I would like to thank my supervisor Tomas Grönstedt for providing crucial support in key moments during my research studies and for many enjoyable discussions, not always limited strictly to work matters. I also want to thank him for accommodating my sabbatical to go traveling in the middle of my Ph.D. I would like to thank Visakha Raja for our cooperation and shared challenges during the first part of my Ph.D. Furthermore, I would like to thank Anders Lundbladh for sharing his wide-ranging knowledge in the field of aeronautics and for always being available to answer questions. I extend my thanks also to Carlos Xisto, for our GESTPAN-related chats, and to Olivier Petit for support in the CENTRELINE project. During my time at Chalmers, I have had the fortune of always sharing an office with nice people. For this I am grateful to Xin Zhao, Oskar Thulin, Isak Jonsson, Vinicius Tavares Silva and Lucilene Moraes da Silva. I would also like to thank my other colleagues at the Division of Fluid Dynamics for contributing to a great working environment. Finally, and most of all, I would like to thank my family for always being there to support me. You mean a lot to me.

It is not down on any map; true places never are

-Herman Melville

NOMENCLATURE

A	Area
AC	Alternating current
ACC	Active clearance control
ATM	Air traffic management
BLI	Boundary layer ingestion
BPR	Bypass ratio
CAS	Calibrated air speed
CENTRELINE	Concept validation study for fuselage wake-filling propulsion integration
CFD	Computational fluid dynamics
CO	Carbon monoxide
CO ₂	Carbon dioxide
CORSIA	Carbon offsetting and reduction scheme for international aviation
DC	Direct current
EASA	European Aviation Safety Agency
EPR	Engine pressure ratio
EU	European Union
ETS	Emissions trading system
FEM	Finite element method
FHV	Fuel heating value
FN, F _N	Net thrust
FPR	Fan pressure ratio
GESTPAN	General stationary and transient propulsion analysis
HC	Hydrocarbon
HPC	High pressure compressor
HPT	High pressure turbine
ICAO	International Civil Aviation Organization
IEA	International Energy Agency
ISA	International standard atmosphere
LPT	Low pressure turbine
LUAX-T	Lund University axial turbine
M	Mach number
m	Mass flow
MCT	Max continuous thrust
MTO	Max take-off
N ₁	Fan spool speed
N _{1corr}	Fan corrected spool speed
NEWAC	New aero engine core concepts
NHATC	Non-hierarchical analytical target cascading
NO _x	Nitrogen oxides
OAT	Outside air temperature
OPR	Overall pressure ratio
P	Power

p_0	Total pressure
PFC	Propulsive fuselage concept
Q_F	Fuel heating value
R	Degree of reaction
RPK	Revenue passenger kilometer
SFC	Specific fuel consumption
T_0	Total temperature
T_2	Total temperature at fan face
T_{41}	Turbine inlet temperature
TRS	Turbine rear structure
TSP	Thrust setting parameter
U	Blade speed
V	Velocity
v	Absolute velocity
VBV	Variable bleed valve
VITAL	Environmentally friendly aero engine
VSV	Variable stator vane
W_{25R}	HPC inlet corrected mass flow
W_F	Fuel flow
w	Relative velocity
WEICO	Weight and cost estimation
ΔH	Change in total enthalpy
α	Absolute flow angle
β	Relative flow angle
γ	Specific heat ratio
η	Efficiency
ρ	Density
ϕ	Flow coefficient
ψ	Stage loading

CONTENTS

Abstract	i
List of publications	iii
Acknowledgments	v
Nomenclature	ix
1 Introduction	1
1.1 Environmental impact from aviation	1
1.2 Emissions mitigation strategies	2
1.2.1 Technology improvements.....	2
1.2.2 Alternative fuels.....	2
1.2.3 Operational improvements	3
1.2.4 Regulations	3
1.3 The turbofan engine	4
1.4 Scope of work.....	6
2 Engine performance and conceptual design	7
2.1 Performance modeling.....	8
2.2 Modeling tools	9
2.2.1 Engine performance	9
2.2.2 Engine weight and dimensions.....	10
2.2.3 LPT mean-line design.....	10
2.3 Consistent point analysis.....	10
2.3.1 Potential applications of consistent design	11
3 Part-load performance modeling	13
3.1 Flight envelope	13
3.2 Sizing operating conditions.....	14
3.3 Engine thrust management.....	14
3.4 Engine part-load considerations	16
3.5 Operating engines at part-load	17
3.6 Modeling procedure	17
4 Multidisciplinary design and optimization	19

4.1	Low pressure turbine	19
4.2	Turbine rear structure	20
4.3	Coordination of multidisciplinary optimization problems	21
5	Boundary layer ingestion.....	25
5.1	Boundary layer ingestion modeling.....	27
6	Summary of papers.....	29
6.1	Paper I.....	29
6.1.1	Division of work.....	29
6.2	Paper II.....	29
6.2.1	Division of work.....	30
6.3	Paper III.....	30
6.3.1	Division of work.....	30
6.4	Paper IV.....	30
6.4.1	Division of work.....	31
6.5	Paper V.....	31
6.5.1	Division of work.....	31
6.6	Paper VI.....	31
6.6.1	Division of work.....	32
6.7	Paper VII.....	32
6.7.1	Division of work.....	32
7	Conclusion.....	35
	References	37

1 Introduction

In little over a century, aviation has gone from its first powered, heavier-than-air flight to one of the dominant modes of transport. Like few other technologies, it has enabled connecting people from different continents and contributed to making far-flung places on the globe more accessible.

Air traffic in terms of revenue passenger kilometers (RPK) doubled between 2003 and 2017 [1] and is forecasted by Boeing to grow at an annual rate of 4.6% [2], see Fig. 1, for the coming 20 years. The International Energy Agency (IEA) has forecasted a more modest growth of 3.8% annually [3]. Efficiency improvements meant that carbon dioxide (CO₂) emissions per passenger kilometer decreased at a rate of around 2.6% per year from 1990 to 2014 [4]. However, this rate is forecast to slow to an annual average rate of 1.3% [3] in the IEA's Efficient World Scenario, which means that aviation's CO₂ emissions are projected to grow substantially in the coming 20 years.

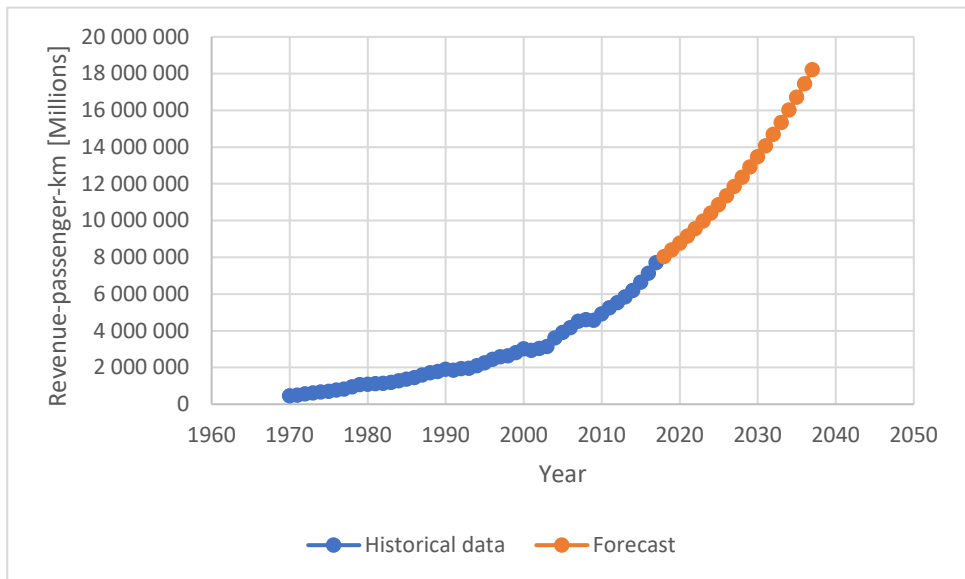

Fig. 1. Trend in global revenue-passenger-kilometers [2, 4].

1.1 Environmental impact from aviation

Several emissions from aircraft engines affect the climate and the environment. Carbon dioxide emissions contribute to global warming by creating a positive radiative forcing [6]. Nitrogen oxides (NO_x) have both a cooling effect and a

warming effect on the climate [7]. When NO_x is broken down ozone is formed which has a warming effect. However, NO_x also helps to break down the strong climate warming gas methane, which means that NO_x can be said to have a cooling effect in this case. The net effect of NO_x is a positive radiative forcing [6]. Furthermore, NO_x is detrimental to health [8], which is mainly a problem at taxi, take-off and landing. Moreover, aircraft engines emit soot particles, which can be harmful if ingested into the lungs. In addition, soot particles act as nuclei for the forming of ice particles that cause contrail cirrus at high altitudes [9]. Contrail cirrus is a strong radiative forcer. Current estimates contain large uncertainties, but its effect is estimated to be of approximately equal magnitude as carbon dioxide emissions from air travel [6].

1.2 Emissions mitigation strategies

There are several strategies to reduce the environmental impact of aviation. They can be broadly divided into four categories: technical, alternative fuels, operational and regulatory. This section will give a brief overview of these different strategies.

1.2.1 Technology improvements

As mentioned earlier, the aerospace industry has done a great deal to improve the fuel efficiency of its operations. Many of these improvements have come thanks to technical advancements. Examples include the introduction of the turbofan engine to replace the more fuel-consuming turbojet in commercial aircraft and the fitting of winglets on the wings to reduce induced drag [10].

A wide variety of potential future technologies are currently being studied. These include for example novel engine architectures, such as intercooled engines [11], pulse detonation combustion [12], piston-topping [13, 14] and open rotors [15, 16]; new ways of integrating the wings and propulsion systems into the aircraft, such as blended-wing-bodies [17] or distributed propulsion [18, 19]; and a higher degree of electrification, to name a few.

1.2.2 Alternative fuels

Another way of lowering the environmental impact of aviation is to replace the fossil fuels that are currently powering almost all air travel with renewable energy sources. Drop-in biofuels can be used with current engines and is already utilized by some airlines to a limited extent. The biofuels that have been certified to date are allowed to be used at a maximum share of 50% together with fossil jet fuel [20]. The advantage of these fuels is that they can be used with current aircraft and the logistics at the airports is similar to what is already in place. If the biofuels are sustainably sourced, they will contribute to lower net emissions of CO_2 . A research study [21] also indicated that using a higher share of biofuels can lead to lower soot emissions, which could reduce the formation of contrail cirrus [9]. A limiting factor

could be the availability of bio-mass and the large areas required to grow energy crops. If not managed properly, this could cause, for example, competition with food production.

Another fuel under consideration is hydrogen [22], which would require a re-design of the aircraft due to the higher fuel tank volumes required. It would also require infrastructure solutions for distribution and storage. However, if the hydrogen used can be produced from renewable energy, such as solar or wind power it can prove nearly carbon neutral.

Electric propulsion has also garnered attention recently, both fully electric and hybrid-electric concepts. There are several start-up companies currently developing electric aircraft, such as Zunum Aero [23], Wright Electric [24] and Heart Aerospace [25]. A two-seat aircraft, the Pipistrel Alpha Electro [26], is already on the market. The main challenge for electric aircraft is the range limitation currently imposed by the large battery masses required. Without revolutionary developments in battery technology, fully electric aircraft are not projected to be viable for long-range applications in the foreseeable future [27]. They have the potential, however, to compete on the regional airline market and to facilitate air travel on shorter, low traffic volume routes that are currently not profitable to operate.

1.2.3 Operational improvements

There are also opportunities to operate the existing fleet in a more efficient way. Improved air traffic management (ATM) can lead to straighter flight routes and thus shorter flight distances and reduced fuel consumption. For long-haul flights, staged flights are beneficial from a fuel burn perspective [28]. That is due to the large fuel quantities needed for long-range operations. This fuel will add a significant amount of mass to the aircraft in the first part of the flight, which will cause the fuel consumption to increase. If instead aircraft optimized for a shorter stage length are used in several flight stages, the total fuel consumption will be lower, especially if this is combined with seating arrangements more typical of short and medium-range aircraft.

To avoid contrail formation, operations can be adapted to fly at a lower, or possibly higher, altitude in regions where the risk of contrail formation is large [29, 30], or to fly around those regions.

1.2.4 Regulations

In order to create incentives for the industry to improve energy efficiency, a number of regulations have been or will be implemented. The European Union (EU) emissions trading system (ETS) encompasses heavy energy-users such as power stations and industrial plants as well as flights within the EU, Iceland,

Norway and Liechtenstein (although Liechtenstein does not have an airport) [31]. The ETS is a cap-and-trade system, meaning that a limit is set on the total annual emissions of a gas from the industries covered by the system. This cap is then reduced with time so that total emissions fall. Companies can receive or buy emission allowances. The allowances can be traded, with the intention that emissions reductions will then be implemented where it is the least costly. The idea is that this will foster carbon emission reduction in the most cost-efficient way.

ICAO have also introduced a measure for carbon offsetting and reduction called CORSIA [32]. CORSIA aims at carbon neutral growth from aviation compared to a 2020 baseline. Airlines can achieve this either by stabilizing their emissions or by investing in approved carbon offsetting schemes to reduce emissions in other sectors. The pilot phase of CORSIA is set to start in 2021 and, as of July 2019, 81 states covering 77% of international aviation activity intend to participate from the outset [32].

There have also been more local initiatives. In 2018, Sweden introduced an aviation tax [33]. A fixed amount is taxed per ticket, with the intention to dampen demand. There is also a proposal to introduce an emissions reduction obligation for aviation fuels, meaning that the fuel supplier is mandated to reduce net CO₂ emissions by blending biofuels into the supplied aviation fuel [34].

1.3 The turbofan engine

The work contained in this thesis is focused mainly on the aircraft propulsion system, particularly the turbofan engine. It is the dominating jet engine type for civil aviation. It was introduced in order to lower fuel consumption as well as noise levels from the turbojet engine from which it is derived. The turbojet uses all intake air for combustion. In modern turbofans, most of the ingested air is directed through the bypass duct after being compressed by the fan. A smaller fraction of the intake mass flow passes through the engine core. The core mass flow is further compressed through the intermediate and high pressure compressors. The compressed air is then mixed with fuel and burned. It is subsequently expanded through the turbines that drive the compressors (including the fan) before it is exhausted through the nozzle to generate thrust. The expression for net thrust (F_N) for fully expanded flow is derived from the momentum equation and is expressed in Eq. (1)

$$F_N = W_j V_j - W_i V_i \quad (1)$$

with W_j representing the jet mass flow, V_j the jet velocity, W_i the intake mass flow and V_i the flight velocity.

A common metric for assessing the fuel efficiency of turbofan engines is the specific fuel consumption (SFC), which is defined as the fuel mass flow (W_F) per unit of net thrust.

$$SFC = \frac{W_F}{F_N} \quad (2)$$

When quantifying the efficiency of the engine, the overall efficiency (η_o) is often divided into thermal efficiency (η_{th}) and propulsive efficiency (η_p). The thermal efficiency is a measure of how efficiently the energy supplied in the fuel is converted to potentially useful kinetic energy. The propulsive efficiency specifies how well this potentially useful kinetic energy is used to produce thrust.

$$\eta_{th} = \frac{W_j \frac{V_j^2}{2} - W_i \frac{V_i^2}{2}}{W_F Q_F} \quad (3)$$

$$\eta_p = \frac{F_N V_i}{W_j \frac{V_j^2}{2} - W_i \frac{V_i^2}{2}} \approx \frac{2}{1 + \frac{V_j}{V_i}} \quad (4)$$

with Q_F denoting the fuel heating value.

The overall efficiency is the ratio of produced thrust power to the rate of energy supplied in the fuel and thus the product of η_{th} and η_p .

$$\eta_o = \frac{F_N V_i}{W_F Q_F} = \frac{V_i}{SFC \times Q_F} = \eta_{th} \eta_p \quad (5)$$

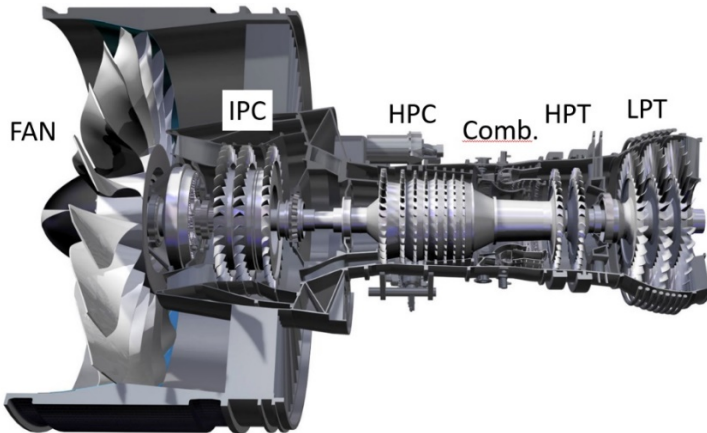

Fig. 2. Cut-away of the PW1100G. The fan and intermediate pressure compressor (IPC) are driven by the low pressure turbine (LPT). There is a gearbox between the fan and IPC to allow them to rotate at different speeds. The high pressure turbine (HPT) drives the high pressure compressor (HPC). Courtesy of Pratt & Whitney.

1.4 Scope of work

The present thesis can be divided into two main parts. The first part is focused on aircraft engine performance and conceptual design methods and is contained in papers I, II and IV. It aims to assess how interactions between different components affect the engine performance and the optimal engine design. This part was carried out in collaboration with GKN Aerospace and the then Department of Production and Product Development (now called the Department of Industrial and Materials Science) at Chalmers. In the second part, presented in papers III, V, VI and VII, the performance and conceptual design tools used are then expanded to model the propulsion system of a turbo-electric aircraft concept with fuselage boundary layer ingestion. This part aims to explore how a gas turbine engine requiring large generator power offtake should be designed, including how to integrate the electric machinery. It also aims to provide an assessment of the system level benefit of the aircraft concept. In addition to the work contained in the appended papers, part-load performance modeling is discussed as this is required for a complete assessment of the presented engine concept. The second part was mainly conducted within the EU Horizon 2020 project CENTRELINE.

2 Engine performance and conceptual design

When designing an aero engine, several steps need to be undertaken, see Fig. 3. Based on the customer needs and regulatory requirements, which include factors such as reduced fuel burn and noise levels, the most suitable engine must be found. In an initial design phase, a choice of thermodynamic cycle, types and numbers of turbomachinery components and the engine architecture layout is made. The outcome of this phase is usually the same at a given engine manufacturer, due to the associated high risks and development costs of moving to a new architecture. Of the large manufacturers of jet engines for commercial aircraft, General Electric have been associated with a two-shaft architecture, and Rolls-Royce with a three-shaft engine for several decades. However, the third large manufacturer, Pratt & Whitney, have recently decided to move to a two-shaft engine with a geared fan.

After the general layout has been decided upon, the thermodynamic cycle is defined in the engine design point. Here, assumptions are made on for example compressor pressure ratios, component efficiencies, bypass ratio, combustor pressure loss and turbine inlet temperature. The performance is then evaluated in several off-design operating points to make sure the engine cycle meets the constraints posed by these operating conditions. After that, an engine conceptual design is made, where the engine gas path is mapped out, including component inner and outer radii, number of stages, rotational speeds, axial Mach numbers etc. Here, correlations based on existing engine data, such as those in [35], are used to determine hub/tip ratios, stage loadings, airfoil aspect ratios etc. Also, a correlation-based weight assessment is carried out where suitable materials for the components are selected and sizes of shafts, discs and casings etc. are estimated. It is in the domain of the thermodynamic cycle studies and conceptual design that the work in this thesis is mainly carried out. However, also aspects of the preliminary studies and aerodynamic component design have been treated in parts of the work.

Aerodynamic and mechanical design of the individual components is done in several stages of increasing fidelity, starting with cheaper, less time-consuming methods such as through-flow calculations (for the aerodynamics) moving towards full computational fluid dynamics (CFD) simulations and ultimately real component and full engine tests. The process is iterative where findings further down the design process can show the necessity of making changes on a higher level, although this can be costly, in particular late in the design process.

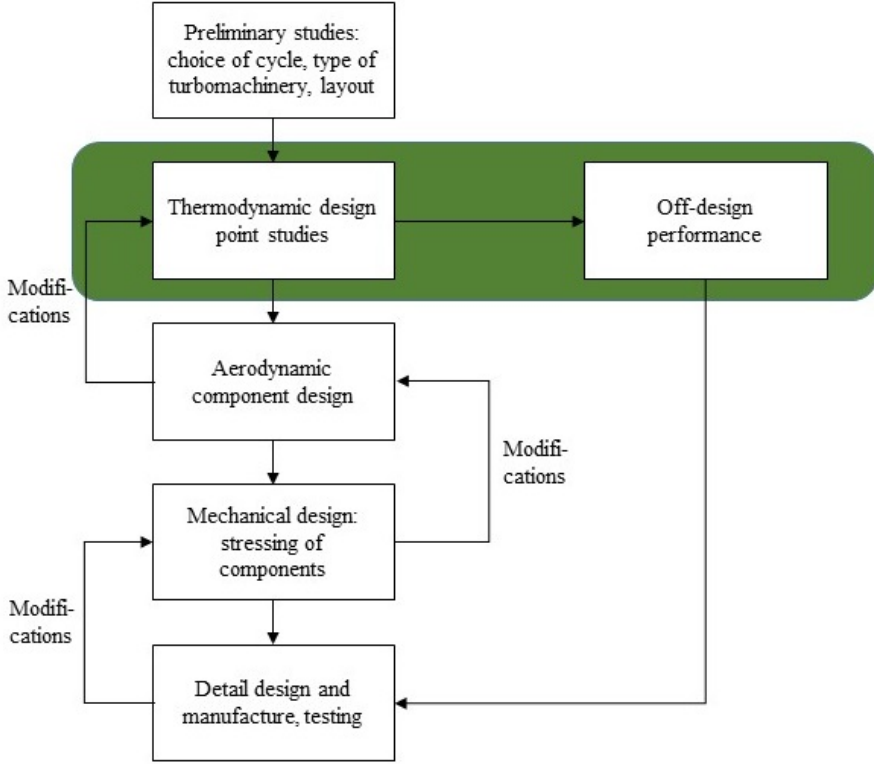

Fig. 3. Gas turbine design procedure adapted from Saravanamuttoo [36]. The green area indicates the main focus of the work in this thesis.

2.1 Performance modeling

While modeling the performance of aero engines, the compatibility equations shown in Eq. (6) must be satisfied. These consist of compatibility of flow, compatibility of rotational speed and compatibility of work. Here x_1, \dots, x_n represent performance iteration variables and f_1, \dots, f_n are corresponding residuals to be iterated to zero.

$$\begin{aligned}
 f_1(x_1, \dots, x_n) &= 0 \\
 f_2(x_1, \dots, x_n) &= 0 \\
 &\vdots \\
 f_n(x_1, \dots, x_n) &= 0
 \end{aligned} \tag{6}$$

Aero engine performance modeling is traditionally carried out in two different modes, the design mode and the off-design mode. In the design mode, assumptions are made on component technology levels, meaning efficiencies, pressure ratios

and turbine inlet temperature, for example. This means that the compatibility equations can be formulated in such a way that they can be solved without iterating, since upstream components give the requirements on the downstream components. For example, the rotational speed and work requirements of the HPC will give the corresponding values for the HPT.

In the off-design mode, iteration variables and corresponding residuals are chosen. The turbomachinery component characteristics are typically contained in performance maps, where the variation of mass flow, pressure ratio and efficiency with rotational speed can be obtained. Since the engine design has already been set, an iterative procedure must be used to match the components. The matching calculations are performed to find the operating point in each component where the compatibility equations are satisfied and the required thrust (or other chosen rating parameter) is met. A detailed explanation of performance calculations can be found in the literature, for example in [36].

2.2 Modeling tools

The performance modeling and conceptual design tools used in this work are briefly presented in this section.

2.2.1 Engine performance

Engine performance calculations carried out in this work have been made using the Chalmers in-house code GESTPAN developed by Grönstedt [37]. GESTPAN is module based meaning that the components that make up the engine are split into separate modules. Examples of modules include inlet, compressor, burner, turbine and nozzle. The advantage of this structure is that it is relatively straightforward to set up models of new engine architectures. The engine model is defined using an input text file where the modules used, and their connections, are defined. The connections are specified by connecting output variables from one module to input variables of another, for example the output temperature of the HPC is connected to the input temperature of the burner. The engine design point is then specified by entering a series of input values, such as flight altitude and Mach number, component efficiencies and compressor pressure ratios. The turbine cooling flow can be set explicitly by the user or is calculated from a maximum permitted blade temperature, based on the method published by Young and Wilcock [38, 39]. Off-design performance can also be computed by defining the flight conditions, i.e. altitude, Mach and temperature deviation from international standard atmosphere (ISA) conditions and an engine rating parameter, for example net thrust, turbine inlet temperature or relative corrected fan speed.

2.2.2 Engine weight and dimensions

The flow-path layout, engine weight and dimensions are modeled using WEICO. WEICO was developed at Chalmers during the European projects NEWAC [40] and VITAL [41]. WEICO is based on the methodology developed by Onat and Klees [42]. WEICO can be run either stand-alone or as an extension to GESTPAN. WEICO calculates the weight and dimensions of each component based on performance output and weight model specific user input data. A range of engine architectures have been defined in WEICO and through an input file, the user specifies which type of engine is modeled, for example a two-shaft or a three-shaft engine. There is a myriad of input options that can be either specified by the user or calculated and given as output, such as hub/tip ratios, blade heights, aspect ratios, Mach numbers, hub and tip radii, stage loadings etc. Default values for the chosen engine architecture and technology level and/or entry into service year are used where no input has been specified by the user.

2.2.3 LPT mean-line design

For the LPT mean-line design conducted as part of Paper V, LUAX-T [43] developed at Lund University was used. LUAX-T is a reduced order through-flow code implemented in MATLAB and capable of designing highly loaded, cooled axial turbines. The calculations are composed of three iteration loops, for cooling, entropy and geometry generation. The input can either be entered through a graphical user interface or by loading a separate input file.

2.3 Consistent point analysis

To better be able to balance different component requirements against each other to create the most optimal engine as a system, it is necessary that the engine designer has access to the most accurate models at all stages of the design process. One way to achieve this is to update the initial assumptions on component technology levels in the thermodynamic cycle calculations, once the conceptual design has been carried out. For example, turbomachinery component efficiencies depend on parameters such as stage loading, Reynolds number and component size. This means that the efficiencies can be updated based on correlations with these parameters, once better estimates of these have been obtained through the conceptual design. The efficiency assumptions in the cycle calculation can then be updated until they are consistent with the correlated values based on the conceptual design output.

Paper I in this thesis introduces a method to implement this process. The algorithm is summarized in Fig. 4. The variables χ_1, \dots, χ_k represent optimization variables, such as for example bypass ratio (BPR), overall pressure ratio (OPR) and fan

pressure ratio (FPR). The parameters to be iterated until they are consistent with assumptions, for example component efficiencies, are represented by $\chi_{k+1}, \dots, \chi_m$.

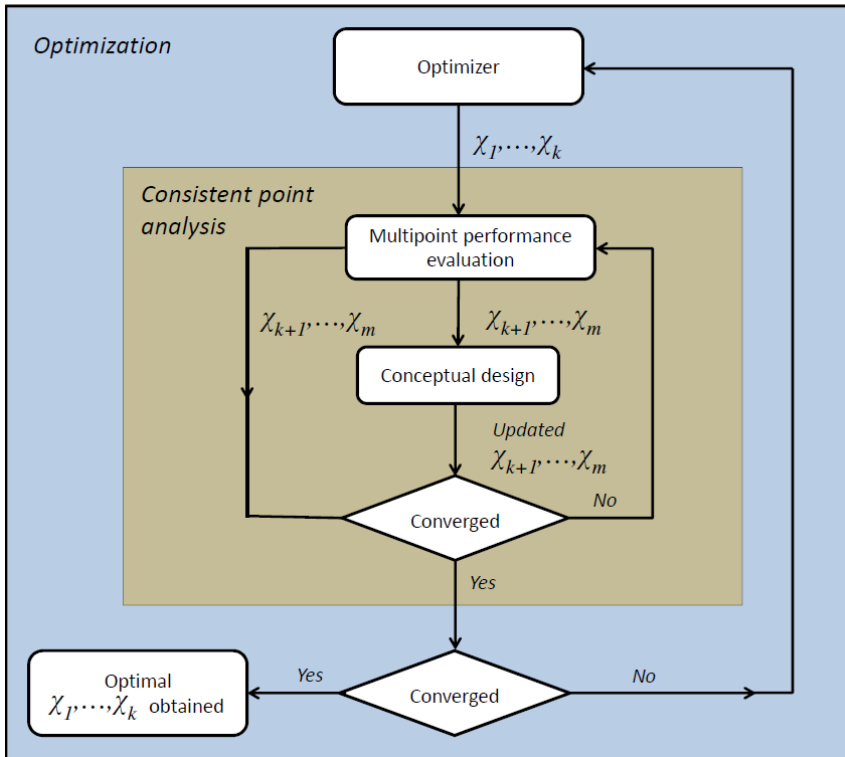

Fig. 4. Consistent conceptual design algorithm.

2.3.1 Potential applications of consistent design

Consistent point analysis can be used to, for example, study the effect on whole engine level if the efficiency can be improved for one component. This effect can be studied for several different cases. The engine conceptual design, i.e. the size of components and shape of the gas path can be kept fix, seeing what effect an increase in a single component efficiency would have. That can be compared with an engine where the conceptual design is re-optimized with the new efficiency, but for a fixed thermodynamic cycle. A third case would allow for re-optimization of the thermodynamic cycle, using the new efficiency.

3 Part-load performance modeling

In this section, the operation and modeling of aero engines' off-design performance will be discussed. In particular, operating conditions with low levels of thrust will be treated. A general introduction to the flight envelope and thrust management of engines is given to understand how the engines operate. This is followed by a description of engine operation at conditions far off-design and how this can be modeled.

3.1 Flight envelope

An aero engine needs to operate safely under strongly varying operating conditions. These include, for instance, take-off on a hot day at a high-altitude airport, top-of-climb at cruise altitude and idling on the ground. The various operating points encountered by an engine are enclosed in what is referred to as the flight envelope, see Fig. 5. The highest required thrust occurs at take-off and go-around (acceleration due to a missed approach) [44]. This thrust level is certified to be maintained for five minutes with all engines operative and ten minutes in case of engine failure at take-off. The highest thrust that can be maintained for the entire duration of the flight is the max continuous thrust (MCT). This thrust represents the thrust needed to fly with one engine out and is not available above a certain altitude [44, 45]. The max climb thrust rating is the highest thrust during normal climb operation. It is available at higher altitudes compared to max continuous thrust. The maximum take-off (MTO) thrust and maximum continuous thrust are the only two thrust settings that an engine is certified for. Other thrust ratings, such as climb, cruise and idle are set or recommended by the engine manufacturer.

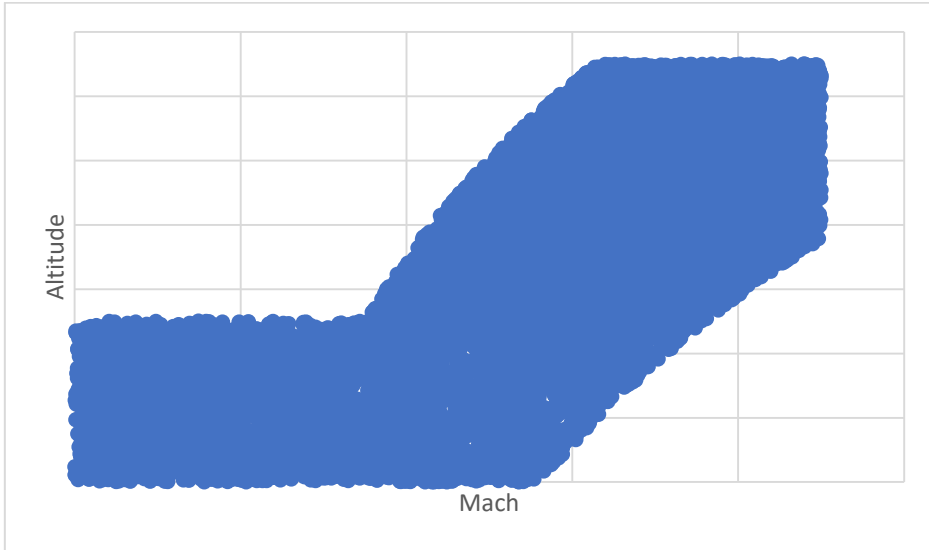

Fig. 5 Scatter plot of operating points enclosed in the flight envelope.

3.2 Sizing operating conditions

The engine must fulfil a set of criteria regarding the performance and safe operation of the engine. The aerodynamic sizing point is typically at top-of-climb, where values for compressor pressure ratios, corrected mass flow and corrected speed are the highest. The mechanical sizing point is typically at take-off, where temperatures (with some exceptions, see section 2.4.4) and rotational speeds are at their peak. The engine must also provide enough thrust to meet take-off field length and initial climb gradient requirements in a one-engine inoperative scenario. The engine should also be sized such that the aircraft can meet its specification on climb time or distance to cruise altitude. As a twin-engine aircraft loses 50% of its available thrust in case one engine fails and a four-engine aircraft only loses 25%, typically the engines for twin-engine aircraft are sized against take-off requirements and those on a four-engine aircraft against climb time/distance [46].

3.3 Engine thrust management

The level of engine thrust must be managed depending on the operating conditions. Commercial aircraft engines are generally operated flat rated. The level of engine thrust is in general limited by the turbine inlet temperature (T_{41}). Thermodynamically, an engine will be able to produce higher thrust for lower outside air temperatures (OAT) at a given atmospheric pressure. However, higher thrust also causes higher mechanical loads on the engine, meaning that it would

have to be over-dimensioned and hence become both more expensive to build and to operate, due to the increased weight. Instead, the engine is rated such that it will give a constant thrust for OATs below a flat rating point. This is what is referred to as flat rated thrust. For OATs above the flat rating point, the thrust will be derated continuously, the higher the OAT, in order to stay below the T_{41} limit. This means that a longer take-off distance is required, if all other conditions remain the same. Some engines have a bump rating setting for hot day conditions at high altitude airports. Here, a higher T_{41} is allowed, facilitating a higher thrust. Operating the engines at a higher rating has an adverse effect on engine life, due to the associated higher mechanical loads. Similarly, for beneficial conditions, including a long runway and lightly loaded aircraft, the engine can be derated [47]. In this case, the engine will provide a lower thrust in order to reduce engine wear and hence extend engine life and reduce maintenance costs.

Typical trends for net thrust (FN), fan shaft speed (N1), corrected fan speed (N1corr), T_{41} and engine pressure ratio (EPR) are shown in Fig. 5. Since in-flight thrust is difficult to measure reliably, a thrust setting parameter (TSP) such as EPR is often used instead [48]. EPR is the ratio of total pressure at the nozzle exit to the engine inlet. Since modern, high-bypass turbofan engines typically have low EPRs, usually N1corr ($N1corr = N1/\sqrt{\theta}$, $\theta = T_2/T_{2ref}$) is used as TSP in its place. While N1 will increase with OAT to provide a constant net thrust, N1corr is flat-rated. N1 increases with OAT since an almost constant mass flow is needed to provide a constant thrust and the lower air density thus means that the shaft needs to rotate faster to achieve this. The mass flow rate at constant calibrated air speed (CAS) is proportional to the square root of the density ratio ρ/ρ_{ref} , which explains why N1corr then becomes flat rated.

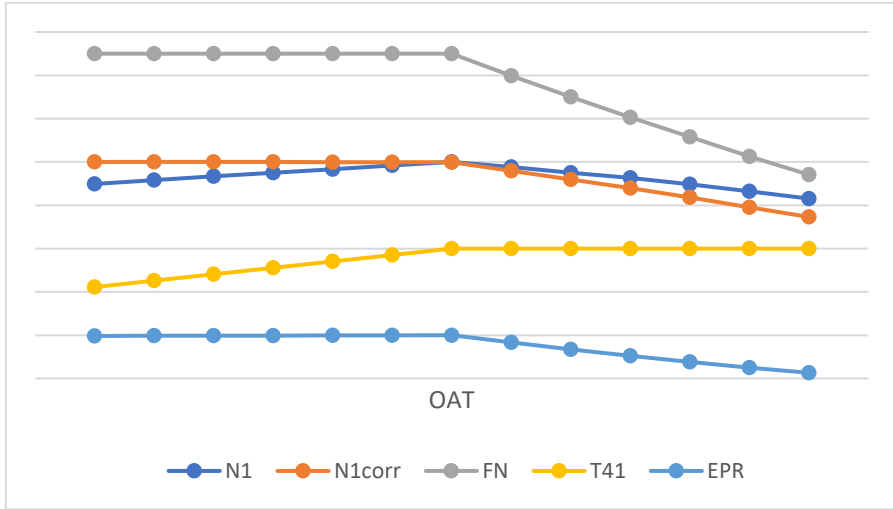

Fig. 6. Flat take-off rating for a typical modern turbofan.

3.4 Engine part-load considerations

In mechanical terms, some of the dimensioning load cases can occur at low thrust operating points. For example, in newer engines with active clearance control (ACC) in the LPT, the exhaust gas temperature can be most critical during engine start [49]. With ACC the LPT case is cooled during the flight to optimize the tip clearance and hence efficiency during cruise. However, when the engine is started, the different thermal expansion properties of the turbine rotor and the case can cause the rotor to expand faster than the case. To prevent this to cause tip rub, i.e. a blade tip touching the case, the case is not cooled during startup [49]. This means that even if the exhaust gas temperatures are lower at startup/ground idle than during take-off, the metal temperatures in the case can reach its maximum here.

Another example is that engine outlet temperatures can achieve its maximum values at ground idle for some engine types. There is a benefit of keeping the thrust and rotational speed levels at idle as low as possible for reasons of fuel consumption, emissions and noise, as well as to avoid excessive braking during taxi [49]. Since most of the thrust in a turbofan engine is produced by the fan, i.e. low pressure system, the work done by the low pressure turbine and hence the temperature drop over it becomes lower for lower thrust levels. At low idle operating points most of the energy conversion will be done in the high pressure system, since this is needed to keep the engine running with its auxiliary functions of supplying the aircraft with electrical power, hydraulic power and cabin bleed. This means that the temperature out from the low pressure turbine can be higher for lower thrust levels at idle. Therefore, when it comes to structures located

behind the LPT, the thermal requirements can be set at low idle settings. Furthermore, heat transfer effects can mean that the thermal stresses can reach their maximum during transient operation, such as engine start, if for example the surface of a component is heated more quickly than its interior. If the convective heat transfer coefficient is much larger than the thermal conductivity of the material, this can occur.

3.5 Operating engines at part-load

Several techniques are used to ensure the reliable operation of the compressors at part load. These include the variable bleed valve (VBV), variable stator vanes (VSV) and additional bleed valves at one or more locations in the HPC [49].

The VBV is located after the booster. At low rotational speeds of the booster the valve is opened to prevent surge in the booster.

In the HPC, at part load, different parts of the compressor will experience different difficulties due to the many number of stages in the component. The mass flow will be reduced causing a higher incidence on the front stages meaning that they will operate closer to stall. To prevent this, variable stator vanes are used in the front stages to reduce the incidence. Conversely, in the rear stages the compressor will operate closer to choking because the annulus area has been specified for a higher pressure ratio at the design point. The reduced density of the air in the last stages will mean a higher velocity and thus a risk of choking. This is prevented by bleeding air in the middle of the compressor [50].

3.6 Modeling procedure

The challenge when it comes to modeling operating points far off-design stems from the limited amount of available data in the open literature together with the numerical difficulties that are encountered. It is clear from the previous discussion that there are several input variables that can be modified, and the available calibration data is often limited to engine emissions certification data at a number of certification operating points.

The ICAO emissions certification data is available online through EASA [51]. It lists the emissions of unburned hydrocarbons (HC), carbon monoxide (CO) and nitrogen oxides (NO_x) as well as smoke number for four different operating points. Apart from emissions, the fuel flow to the engine is published in the certification data. The tests are conducted for 100% thrust, representing take-off, 85% thrust, representing climb out, 30% thrust, representing approach before landing, and 7% thrust, representing ground idle. The engine is mounted on a test stand while carrying out the tests and there is no power extraction or stage bleed. When modeling, therefore, the model should be tuned so that it matches the emissions certification data at the four operating points mentioned above.

For modeling of ground idle operation, first an estimate on the idle thrust must be made. The level of idle thrust is usually lower than 7% which is the idle certification point. Data from several existing engines, gives a correlation of idle thrust with max thrust according to Eq. (7) [52]:

$$\frac{F_{N,\text{idle}}}{F_{N,\text{max}}} = c_1 + c_2 \ln F_{N,\text{max}} \quad (7)$$

Furthermore, the available compressor maps do not cover the operating conditions at low idle settings. The behavior of the compressor must therefore be extrapolated based on correlations in this region. Based on data of existing engines the polytropic efficiency can be expressed as a function of the corrected mass flow (W_{25R}) [52]. For the HPC, a third order polynomial is used according to Eq. (8):

$$\frac{1-\eta_{\text{pol}}}{1-\eta_{\text{pol,max}}} = c_1 \left(\frac{W_{25R}}{W_{25R,\text{max}}} \right)^3 + c_2 \left(\frac{W_{25R}}{W_{25R,\text{max}}} \right)^2 + c_3 \left(\frac{W_{25R}}{W_{25R,\text{max}}} \right) + c_4 \quad (8)$$

with $W_{25R} = \frac{W_{25} \sqrt{T_{25}/T_{25,\text{ref}}}}{p_{25}/p_{25,\text{ref}}}$ and 25 denoting entry to HPC.

4 Multidisciplinary design and optimization

During recent decades, computer simulations as a tool in engineering design has become the standard. The possibility to assess the performance of a product through numerical simulations has created the opportunity to, in a virtual environment, test many different design variations in an inexpensive way. Before the simulation era, a new design was created based on experience from old designs and correlations. A prototype was built and tested and then improved upon in several iterations to obtain a final design. With the aid of for example CFD and Finite Element Method (FEM) simulations the duration and cost of these design iterations have come down significantly. This has facilitated the ability to do much of the optimization work before a prototype is even built. Within each computational discipline, such as fluid dynamics or structural mechanics, the improvement pace has started to slow as the designs get ever more mature. The focus in engineering design method development is therefore gradually shifting towards multidisciplinary and multi-level design. By developing such methods, the interaction between various components in the engine, for example, can be analyzed. In papers II and IV of this thesis, the interaction between two components, the LPT and the turbine rear structure (TRS) and the whole engine performance has been studied.

4.1 Low pressure turbine

The low pressure turbine (LPT) is a component of major importance in engine design. It can contribute up to one third of the power plant weight and up to 15% of the total cost [53]. Since it drives the fan, which contributes most of the thrust in a turbofan engine, its efficiency also has an important influence on the SFC of the engine. The typical exchange ratio of LPT efficiency to total engine efficiency is around 1:0.7, i.e. a 1% change in LPT efficiency gives a 0.7% change in total engine efficiency [53]. In addition, the LPT is an important noise source, especially at low throttle setting such as at approach to landing, where it can add 2dB to the total engine noise [53].

When designing a turbine, a conceptual and preliminary design is done before moving to more detailed 2D and 3D design. The conceptual design includes defining the number of stages, flow areas, rotational speeds, stage loadings and flow coefficients. Furthermore, it can include a mean-line design of the turbine where the velocity triangles are set. Three basic parameters are typically used during mean-line design to characterize the performance of an axial turbine stage. They are the flow coefficient, stage loading and degree of reaction and are defined according to:

$$\psi = \frac{\Delta H}{U^2} = \frac{V_x}{U} (\tan \alpha_2 + \tan \alpha_3) = \phi (\tan \alpha_2 + \tan \alpha_3) \quad (9)$$

$$\phi = \frac{V_x}{U} = \frac{1}{\tan \alpha_2 - \tan \beta_2} \quad (10)$$

$$R = \frac{h_2 - h_3}{h_1 - h_3} = \frac{\phi}{2} (\tan \beta_3 - \tan \beta_2) \quad (11)$$

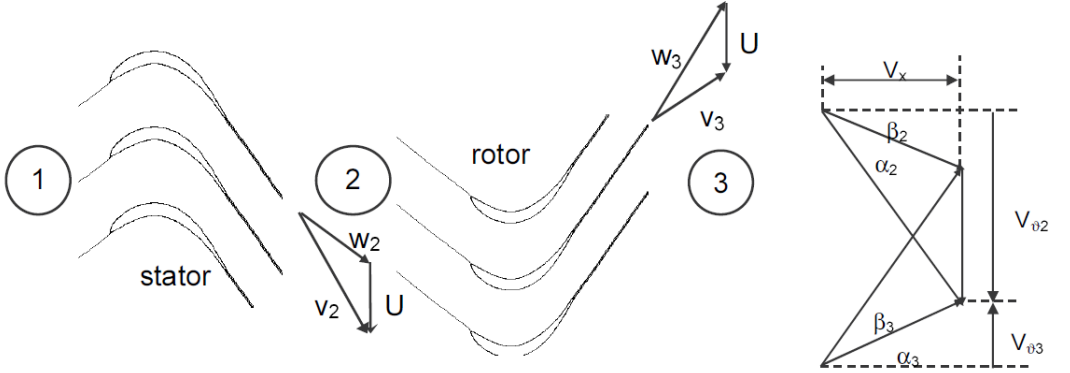

Fig. 7. Velocity triangles for an LPT stage [53].

The parameters defined in the expressions above have been correlated with efficiency by Smith [54]. The correlation shows a trend of higher efficiency with lower stage loading and flow coefficient. In order to reduce the value of these parameters, the mean radius of the LPT usually increases from one stage to another to achieve a higher blade speed U . Another way to decrease the stage loading is to increase the number of stages, but this will increase the length, weight and cost of the component.

In this thesis, the interaction between LPT and TRS was studied in Papers II and IV. Increasing the number of stages allows for a lower stage loading and thus higher efficiency, but at a weight penalty. Moreover, a lower stage loading will be associated with a lower exit swirl angle, see Eq. (9), which means that the TRS will need to provide less turning and the pressure drop in the TRS can be reduced. In addition, a lower turning typically allows for a lighter TRS design [53]. In combination, these factors mean that the last stage of the LPT is usually designed with a lower stage loading to facilitate the most efficient overall design [53].

4.2 Turbine rear structure

The turbine rear structure (TRS) is a static structure situated at the back of the engine, namely behind the low pressure turbine (LPT), see Fig. 8. Its function is to transfer loads from the engine core to the pylon and wing of the aircraft. In modern designs it also has a de-swirling function. Some engines can have a significant amount of outlet swirl from the LPT, which creates a need to de-swirl the flow to utilize the kinetic energy of the core flow in an efficient manner. This is done by

diffusing the swirling component either to increase pressure and thrust of the core nozzle, or to allow expansion to a lower static pressure increasing LPT power output. This means that the TRS vanes have a dual function. Furthermore, these vanes are often used to transfer oil from the aircraft to the engine (for instance for lubrication of the shaft bearings). The various functions of the TRS cause its design to be of a highly multidisciplinary nature.

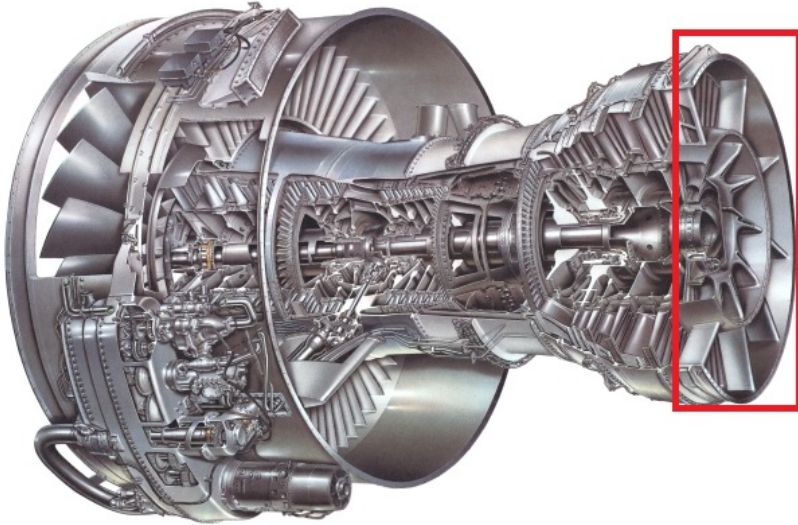

Fig. 8. Location of the TRS in a Rolls-Royce RB211 (Rolls-Royce plc., 2004).

4.3 Coordination of multidisciplinary optimization problems

Engineering companies are often organized so that engineers working within specific disciplines or separate subsystems of a product are placed in different divisions. The consequence of this is that the coordination of a multidisciplinary or multi-level design project becomes a challenging task. There will always be trade-offs that have to be made between different disciplines or subsystems. When deciding which design solution to choose, this can lead to that the division manager with the best verbal skills and negotiating ability will secure a design solution best suited for that manager's discipline. Therefore, it is desirable to have a method that can coordinate a multidisciplinary design problem automatically. One such method is non-hierarchical analytical target cascading (NHATC), developed by Tosserams et al. [55]. In NHATC, the optimization variables in each subsystem are identified, as well as the design constraints. The parameters that are communicated between the different subproblems are divided into targets and responses, see Fig. 9. For a given parameter that is computed in a subproblem (e.g. subproblem j) a response, r_{jn} , is sent to the subproblem which is communicated with (e.g. subproblem n).

Subproblem n then sends back a target, \mathbf{t}_{nj} , for the same parameter to subproblem j . The set of subproblems for which j is computing responses and receiving targets from is denoted R_j .

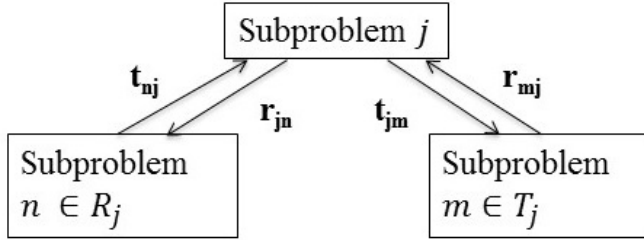

Fig. 9. Structure for a general problem formulated using NHATC [55].

A consistency constraint is then formulated to drive the difference between \mathbf{r}_{jn} and \mathbf{t}_{nj} to zero. Likewise, for the set of subproblems, contained in T_j , that j sends targets to and in which a response is computed and communicated back to j , another consistency constraint is formulated. Consistency is obtained through the utilization of augmented Lagrangian penalty functions denoted π in Eq. (12). The general NHATC problem is formulated in Eq. (12).

$$\begin{aligned} \min_{\bar{\mathbf{x}}} f_j(\bar{\mathbf{x}}) + \sum_{n \in R_j} \pi(\mathbf{t}_{nj} - \mathbf{r}_{jn}) + \sum_{m \in T_j} \pi(\mathbf{t}_{jm} - \mathbf{r}_{mj}) \quad (12) \\ \text{subject to } \mathbf{g}_j(\bar{\mathbf{x}}) \leq \mathbf{0} \\ \text{with } \mathbf{r}_{jn} = \mathbf{S}_{jn} \mathbf{a}_j(\bar{\mathbf{x}}), n \in R_j \\ \bar{\mathbf{x}} = \begin{bmatrix} \mathbf{x}_j \\ \mathbf{t}_{jm} \end{bmatrix}, m \in T_j \end{aligned}$$

Here, $\bar{\mathbf{x}}$ contains the optimization variables, \mathbf{g}_j represents the inequality constraints, \mathbf{S}_{jn} is a selection matrix that selects components from \mathbf{a}_j to be sent to subproblem n . The indexing is organized such that the first index represents the subproblem which sends the parameter and the second index the subproblem that receives the parameter.

The consistency constraints are relaxed through the augmented Lagrangian function π according to Eq. (13), using the penalty parameters \mathbf{v} and \mathbf{w} :

$$\pi(\mathbf{t}_{nj} - \mathbf{r}_{jn}) = \mathbf{v}^T(\mathbf{t}_{nj} - \mathbf{r}_{jn}) + \|\mathbf{w} \circ (\mathbf{t}_{nj} - \mathbf{r}_{jn})\|^2 \quad (13)$$

The symbol \circ represents the Hadamard product, which is an entry-wise multiplication of two vectors, yielding $\mathbf{a} \circ \mathbf{b} = [a_1, \dots, a_n]^T \circ [b_1, \dots, b_n]^T = [a_1 b_1, \dots, a_n b_n]^T$ [55].

The NHATC problem is coordinated using an alternating direction method of multipliers [56]. The subproblems are solved sequentially for a given set of penalty parameters \mathbf{v} and \mathbf{w} . Until convergence is reached, the penalty parameters \mathbf{v} and \mathbf{w} are updated using the formula:

$$\mathbf{v}^{k+1} = \mathbf{v}^k + 2\mathbf{w}^k \circ \mathbf{w}^k \circ \mathbf{q}^k \quad (14)$$

where \mathbf{q} is a vector containing the extended consistency constraints, i.e. the consistency constraints as well as the system-wide inequality and equality constraints. The penalty weight w_i is updated according to:

$$w_i^{k+1} = \begin{cases} w_i^k & \text{if } |q_i^k| \leq \alpha |q_i^{k-1}| \\ \beta w_i^k & \text{if } |q_i^k| > \alpha |q_i^{k-1}| \end{cases} \text{ with } \beta > 1 \text{ and } 0 < \alpha < 1 \quad (15)$$

5 Boundary layer ingestion

One potential way of reducing the fuel consumption of aircraft is through boundary layer ingestion (BLI). When BLI is used, the propulsion system is integrated into a part of the boundary layer on the aircraft surface. Traditionally, integrating the engines into the boundary layer has been avoided in aircraft application due to detrimental effects on engine efficiency, mechanical loads and noise. However, in marine applications it is a well-established method to reduce the power required to propel the ship. The benefit of BLI has also been identified in the literature [57]. Smith [57] estimated a fuel burn reduction of 7% for cruise missiles. However, it is slightly more challenging for aircraft since the aircraft wake is also spread out over the wings.

A few aircraft concepts utilizing BLI have been published in the literature. One of the more renowned is the Double-Bubble, or D8, developed by researchers at MIT [58]. The D8 features a lifting fuselage and tail-mounted boundary layer ingesting engines and is claimed to reduce fuel consumption by 33%.



Fig. 10. The NASA/Aurora D8 ("Double bubble") aircraft concept [59].

The Silent Aircraft initiative developed a blended-wing-body aircraft with boundary layer ingesting rear-mounted engines on top of the aircraft in order to achieve a fuel efficient and quiet design. It was estimated to achieve a 25% fuel burn reduction compared to a conventional aircraft [60].

The Airbus Nautilus concept is powered solely by two high-bypass turbofan engines integrated into a split tail. These engines ingest the entire fuselage boundary layer and the fuel burn reduction has been estimated to 8-10% [61].

A propulsive fuselage concept (PFC) with a turbo-electrically driven aft-fan has also been studied in the EU projects DisPURSAL [62] and CENTRELINE [63]. It has two under-wing podded gas turbine engines and a circumferentially mounted fan located in around the tail-cone of the fuselage. The fuselage fan reduces the momentum deficit in the aircraft wake and lowers the total thrust requirement. The fan is electrically driven and powered by generator offtake from the main under-wing power plants. NASA's version of this concept, the STARC-ABL, is a single-aisle aircraft and is estimated to reduce fuel burn by around 3% [64].



Fig. 11. The NASA STARC-ABL concept. Image credit: NASA.

Despite its relative similarity to conventional aircraft designs many new design challenges arise due to the turbo-electric powertrain and the tail-mounted fan. To be able to ingest a substantial part of the boundary layer, the fan must have a power in the multi-MW range. This means that the generators required become much larger than the ones used for power offtake in conventional aircraft. Currently, the generators are usually integrated in the bottom part of the nacelle and the shaft torque is transferred through an auxiliary gearbox from the engine shaft to the generator [49]. The larger generator required for the turbo-electric aircraft is too large to be integrated in the bottom of the nacelle, without unduly increasing the nacelle size. Instead it must be integrated along the engine axis. This creates additional challenges for the cooling of the generator as well as for example access for maintenance. The space is also limited since hydraulic systems, the cooling

system for the fan gearbox etc. are already integrated into the engine. Moreover, the cables that transfer the electricity from the generator to the electric motor driving the fan need to fit in the wing and fuselage. Due to the generator and electric motor operating with alternating current (AC) and the electricity transfer being most efficient, in terms of size of the cables, with direct current (DC), additional power electronics also need to be included. These consist of a rectifier on the generator side, which also needs to be integrated into the main engine and an inverter on the motor side. These components also require cooling.

The fuselage fan creates additional design challenges due to its location in the tail-cone of the fuselage. For example, enough ground clearance needs to be maintained at take-off to avoid tail-strike or ingesting debris from the runway surface. This might require a longer landing gear, which will add to the aircraft weight and is likely to generate a higher airframe noise, which is especially critical at landing, when the airframe is the major contributor to noise. It is also unclear how the fuselage fan noise will be affected by the distorted inflow, but this is an additional potential challenge.

The benefit of BLI comes from the fact that less power is needed to impart a given amount of momentum on the flow if the entering flow has a lower velocity [65]. The practical challenges involved stem from the effects of the distorted flow profile of the fluid entering the propulsor, which typically include lower component efficiency.

Rolt and Whurr published a study on a fuselage BLI aircraft concept [66]. They established fuel burn results for both a turbo-electrically and a gas turbine driven aft-fan. They showed a similar fuel burn reduction of around 3.5%. It is worth noting that the turbo-electric version assumed an electric machinery technology level based on the availability of superconducting components. Rolt and Whurr's concept ingested 82.5% of the boundary layer, but they noted that the biggest gain comes from ingesting the inner 40-50%. They also stated that if the transfer efficiency of the BLI propulsor is lower it may not pay to target the outer part of the boundary layer at all. In addition, they pointed out that if several small engines are used in a distributed propulsion concept, the reduction in thermal efficiency can offset the gains.

5.1 Boundary layer ingestion modeling

Lundbladh and Grönstedt [18] presented a method of thrust and drag accounting for boundary layer ingesting propulsors. Traditionally, the propulsive and thermal efficiencies are defined according to Eqs. (16) and (17).

$$\eta_p = \frac{V_0 F_N}{P_J - P_0} \quad (16)$$

$$\eta_{th} = \frac{P_j - P_0}{W_F Q_F} \quad (17)$$

According to this definition intake losses will cause the thermal efficiency to decrease. However, if the intake of the propulsion unit is located in the boundary layer of a part of the aircraft, the drag of this part will manifest as an intake pressure loss. In that case, the drag is included as a loss in thermal efficiency and should not be included in the aircraft drag. To avoid the counterintuitive nature of having a down-stream component affecting the drag of an upstream component, Lundbladh and Grönstedt proposed an alternative thrust-and-drag accounting method. For the case that the static pressure immediately upstream of the intake is equal to the freestream pressure the efficiencies are defined as:

$$\eta_p = \frac{V_0 F_N}{P_j - P_i} \quad (18)$$

$$\eta_{th} = \frac{P_j - P_i}{W_F Q_F} \quad (19)$$

$$P_i = W_i V_i^2 / 2 \quad (20)$$

The net thrust is defined as:

$$F_N = W_j V_j - W_i V_i \quad (21)$$

with V_i taken as the velocity immediately upstream of the intake. In the general case V_i , then called the equivalent velocity, should be calculated as the velocity that would result from expanding the total pressure at the intake to the freestream static pressure. Employing these definitions, the efficiencies and thrust only depend on what happens from the propulsor intake to exhaust and the drag ahead of the intake is included in the airframe drag. The engine cycle is then calculated as usual, starting from the lower total pressure at the intake.

6 Summary of papers

In this chapter, a short summary of the appended papers will be provided along with a contribution report for each paper.

6.1 Paper I

S. Samuelsson, K.G. Kyprianidis and T. Grönstedt, 2015, "Consistent Conceptual Design and Performance Modeling of Aero Engines", *ASME Turbo Expo 2015, GT2015-43331, Montréal, Canada*

When carrying out engine cycle optimization and conceptual design, typically assumptions on component efficiencies are made at the outset of the cycle optimization. This may lead to a suboptimal design if too conservative assumptions are made and conversely, if too optimistic assumptions are made, they will lead to weaker performance than predicted. However, after performing conceptual design, more accurate values of parameters such as stage loadings can be obtained. The component efficiencies can be correlated with these parameters to update the efficiency assumptions. In this paper, a method is presented where the component efficiencies are updated inside the optimization loop based on the conceptual design output. This facilitates an engine cycle optimization that is consistent with the parameters calculated in the conceptual design. To demonstrate the method, a long-range geared turbofan was optimized using both the traditional approach and the consistent optimization method. The results showed that using the consistent optimization method gave a different pressure ratio split between the IPC and HPC as well as providing a 1% lower SFC as it was better able to balance the performance of the different components.

6.1.1 Division of work

The paper was conceptualized by Grönstedt and Kyprianidis. The consistent optimization method was implemented in GESTPAN by Samuelsson and Grönstedt. Samuelsson carried out the optimization studies and wrote the paper, assisted by Grönstedt. Kyprianidis provided comments on the paper.

6.2 Paper II

V. Raja, S. Samuelsson, O. Isaksson and T. Grönstedt, 2015, "Exploring Influence of Static Engine Component Design Variables on System Level Performance", *ISABE 2015, ISABE2015-20082, Phoenix, United States*

A coupling study was performed where the effect of TRS design variables on the overall engine performance were studied. The results showed that a mis-matched TRS with respect to the LPT causes an SFC penalty of up to 0.9% and this was taken as motivation for further studies of the TRS interaction with the LPT.

Furthermore, the authors came to the insight that a more detailed model of the LPT was needed to be able to obtain more meaningful results on the coupled design of the LPT and TRS, which constituted the basis for Paper IV.

6.2.1 Division of work

The paper was conceptualized by Raja and Samuelsson, with input from Grönstedt and Isaksson. Raja performed the analysis of the TRS design. Using the TRS performance output, Samuelsson carried out the engine performance modeling. Raja and Samuelsson wrote the paper, with Raja leading the effort. Feedback was provided by Isaksson and Grönstedt.

6.3 Paper III

A. Seitz, F. Peter, J. Bijewitz, A. Habermann, Z. Goraj, M. Kowalski, A. Castillo Pardo, C. Hall, F. Meller, R. Merkler, O. Petit, S. Samuelsson, B. Della Corte, M. van Sluis, G. Wortmann and M. Dietz, 2018, "Concept Validation Study for Fuselage Wake-filling Propulsion Integration", *ICAS 2018, Belo Horizonte, Brazil*

In this paper, an overview of the CENTRELINE project is given along with intermediate results at an early stage of the project.

6.3.1 Division of work

The outline of the paper was provided by Seitz, who also synthesized the paper. All project partners provided input in their area of responsibility in the project. Samuelsson wrote the section about the main power plants (Section 7.3).

6.4 Paper IV

X. Zhao, V. Raja, S. Samuelsson, O. Isaksson, A. Lundbladh and T. Grönstedt, 2019, "Conceptual Mean-line Design of a Low Pressure Turbine for a Geared Turbofan with Rear Structure Interaction", *ISABE 2019, ISABE2019-24345, Canberra, Australia*

The coupled performance of an LPT and TRS in a geared turbofan engine is studied further in this paper. A mean-line design of the LPT is performed and its interaction with the TRS is analyzed. The hade angle of the LPT is varied for a 3-stage and a 4-stage design. The LPT outflow angle and Mach number are then fed to the TRS design to compute a pressure drop and TRS weight. The results showed that if the LPT design is done in isolation of the TRS, a 3-stage design is optimal, while if the TRS is considered, a 4-stage design is optimal. Therefore, it was concluded that an integrated design of the LPT and TRS is necessary to obtain the best design.

6.4.1 Division of work

The paper was conceived by Samuelsson and Raja, with feedback from Grönstedt and Isaksson. The LPT mean-line design was made by Samuelsson. Zhao and Raja carried out the simulations for LPT and TRS, respectively. Zhao wrote the paper with input provided by Raja. Isaksson, Grönstedt and Lundbladh provided feedback. Samuelsson edited the paper before submission.

6.5 Paper V

S. Samuelsson, O. Petit, R. Merkler and G. Wortmann, 2019, “Adaption of a Turbofan Engine for High Power Offtakes for a Turbo-electric Propulsive Fuselage Concept”, *ISABE 2019, ISABE2019-24215, Canberra, Australia*

The performance characteristics and conceptual design of a geared turbofan designed for the large power offtake required for the turbo-electric propulsive fuselage concept. The power offtake is extracted from a free power turbine (PT) stage located after the LPT. The PT features variable area to be able to independently control thrust and power offtake. An advantage of introducing the PT is that the rotational speed can be chosen to suit the generator that needs to be integrated on the engine axis due to its size. The engines show a reduction in fan diameter of 11% and weight of 13% (excluding electric machinery weight) compared to a geared turbofan for a reference aircraft.

6.5.1 Division of work

The work in the paper was performed as part of the CENTRELINE project and was conducted in parallel with the work presented in Paper VI. The paper was conceived by Samuelsson, Petit, Merkler and Wortmann. Samuelsson implemented the engine model in GESTPAN and WEICO, set up and performed the engine performance and conceptual design of the engine, and wrote the paper. Merkler provided input regarding integration aspects and Wortmann provided input on the electric machinery implications. They also provided feedback on the paper.

6.6 Paper VI

R. Merkler, S. Samuelsson and G. Wortmann, 2019, “Integration Aspects for Large Generators into Turbofan Engines for a Turbo-electric Propulsive Fuselage Concept”, *ISABE 2019, ISABE2019-24087, Canberra, Australia*

In Paper VI, the integration aspects of the engine concept presented in Paper V are presented. The down-selection process for choosing the most suitable way of integrating the generator is laid out. This leads to the choice of integrating the generator in the turbine section of the engine. Locating the generator in the aft

part of the engine reduces the bending moment on the pylon, compared to locating it further forward in the engine. It also enables the introduction of a free power turbine for power offtake, which is beneficial for the generator mass as the rotational speed can be adapted to its operation. Also, the thermal integration aspects are presented. The power electronics are air-cooled and integrated in the bypass duct. The generator is oil-cooled and thermally shielded by a jacket. The oil is cooled using an air-cooled oil-cooler integrated in the bypass duct, which causes an additional pressure loss. This is also identified as the most important drawback of the chosen integration concept.

6.6.1 Division of work

The work in the paper was performed as part of the CENTRELINE project and was conducted in parallel with the work presented in Paper VI. The publication was conceived by Merkler, Samuelsson and Wortmann. Merkler provided the expertise on how to integrate the electric machinery in the engine and wrote the paper. Samuelsson contributed with analysis of the impact on engine performance and provided cross-sectional drawings of the engine and gave feedback on the paper. Wortmann provided the knowledge of the electric machinery, including mass estimates and gave feedback on the paper.

6.7 Paper VII

S. Samuelsson and T. Grönstedt, 2019, “Performance Analysis of Turbo-electric Propulsion System with Boundary Layer Ingestion”

Submitted to Aerospace Science and Technology

A performance analysis of a propulsive fuselage concept was conducted. The fuselage aft-mounted BLI fan diameter was varied to obtain an optimal amount of ingested boundary layer. The analysis showed a fuel burn reduction of 0.6% using conventional electric machinery and 3.6% using superconducting electric machinery. The results show that all of the benefit is achieved from ingesting the lower-velocity inner part of the boundary layer. Even with superconducting electric machinery, the benefit of ingesting the outer half, in momentum-deficit terms, of the boundary layer is minimal. The electric machinery losses and efficiency penalty of the fuselage fan operating in distorted inflow more than offset the theoretical gain of capturing the outermost part of the boundary layer. It is concluded that this leads to only modest gains in achievable fuel burn reduction despite previous studies showing a large theoretical potential for the concept.

6.7.1 Division of work

The paper was conceived by Samuelsson, with assistance from Grönstedt. Samuelsson extended GESTPAN and WEICO to model the propulsion system including the turbo-electric power train and fuselage fan. Samuelsson also set up

and performed the simulations and results analysis. Samuelsson wrote the paper, with feedback from Grönstedt.

7 Conclusion

Two routes to making air travel more efficient have been presented. The first route concerned improved methods for integrated assessment of the engine. The presented consistent conceptual design method showed that the design space is more fully explored if conceptual design output is used to update the assumptions made in the cycle calculations. This led to that component pressure ratios could be more optimally balanced. The method will also reduce the risk of making too optimistic assumptions on component performance and thus the need for costly changes late in the design process. Furthermore, an integrated assessment of a low pressure turbine and a turbine rear structure was presented. It showed the importance of considering component design interactions as an optimal design of an isolated LPT led to a suboptimal design of the LPT with TRS. In order to include more design variables and constraints into the model, an automated optimization method such as non-hierarchical analytic target cascading could be used. One of the challenges involved with this would be how to include engineering judgment, since all constraints involved in a component or full engine design are difficult to implement in an automated way.

The second route involved studying a propulsive fuselage aircraft concept. A main power plant design featuring a free power turbine accommodating large power offtakes was suggested. One advantage is that this design choice facilitates a compact generator design and creates a buffer against torque oscillations that can occur during abnormal operation of the generator. A disadvantage is the additional pressure loss in the bypass channel that is caused by the required cooling system. There are also design challenges regarding the power turbine, as it requires variable geometry. This will add mass and cause an additional performance penalty.

The system level performance of the propulsive fuselage concept has also been assessed, being one of the more promising boundary layer ingesting configurations. The analysis showed the practical challenges of fulfilling the theoretical promise of the concept. It was determined that little benefit can be obtained from ingesting the outer part of the fuselage boundary layer, due to the small difference between the mean flow properties in this part of the boundary layer and the free-stream conditions. The losses in electric machinery and lower efficiency of the fuselage fan compared to the main engine fan more than compensated for the small gain that could otherwise be achieved by ingesting the outer part of the boundary layer. To be able to realize a higher benefit from fuselage boundary layer ingestion, the associated losses must be minimized. However, the analysis showed that even with superconducting electric machinery only a modest benefit can be obtained, highlighting the technological challenges in achieving the theoretical potential of this concept.

References

- [1] Airbus S.A.S., "Global Market Forecast - Global Networks, Global Citizens 2018-2037," 2018.
- [2] Boeing, "Commercial Market Outlook 2019-2038," 2019.
- [3] IEA, "Energy efficiency 2018," 2018.
- [4] A. Lundblad, "Miljö och framtid för flygmotorer," 26 January 2018. [Online]. Available: https://research.chalmers.se/publication/503106/file/503106_Fulltext.pdf. [Accessed 27 September 2019].
- [5] Trafikanalys, "Luftfart 2018," 27 March 2019. [Online]. Available: <https://www.trafa.se/globalassets/statistik/luftfart/2018/tabellverk-luftfart-2018.xlsx>. [Accessed 25 September 2019].
- [6] D. S. Lee, D. W. Fahey, P. M. Forster, P. J. Newton, R. C. Wit, L. L. Lim, B. Owena and R. Sausen, "Aviation and global climate change in the 21st century," *Atmospheric Environment*, vol. 43, pp. 3520-3537, 2009.
- [7] R. Sausen, I. Isaksen, V. Grewe, D. Hauglustaine, D. S. Lee, G. Myhre, M. O. Köhler, G. Pitari, U. Schumann, F. Stordal and C. Zerefos, "Aviation radiative forcing in 2000: An update on IPCC (1999)," *Meteorologische Zeitschrift*, vol. 14, no. 4, pp. 555-561, 2005.
- [8] M. Kampa and E. Castanas, "Human health effects of air pollution," *Environmental Pollution*, vol. 151, no. 2, pp. 362-367, 2008.
- [9] L. Bock and U. Burkhardt, "Contrail cirrus radiative forcing for future air traffic," *Atmospheric Chemistry and Physics*, vol. 19, pp. 8163-8174, 2019.
- [10] R. T. Whitcomb, "A design approach and selected wind-tunnel results at high subsonic speeds for wing-tip mounted winglets," NASA, Washington, DC, United States, 1976.
- [11] K. G. Kyprianidis, T. Grönstedt, S. Ogaji, P. Pilidis and R. Singh, "Assessment of future aero-engine design with intercooled and intercooled recuperated cores," *Journal of Engineering for Gas Turbines and Power*, vol. 133, 2011.

- [12] C. Xisto, F. Ali, O. Petit, T. Grönstedt, A. Rolt and A. Lundblad, "Analytical model for the performance estimation of pre-cooled pulse detonation turbofan engines," in *ASME Turbo Expo 2017: Turbomachinery Technical Conference and Exposition*, Charlotte, NC, United States, 2017.
- [13] T. Grönstedt et al., "Ultra-low emission technology innovations for mid-century aircraft turbine engines," in *ASME Turbo Expo 2016: Turbomachinery Technical Conference and Exposition*, Seoul, South Korea, 2016.
- [14] S. Kaiser, A. Seitz, S. Donnerhack and A. Lundblad, "Composite Cycle Engine Concept with Hectopressure Ratio," *Journal of Propulsion and Power*, vol. 32, no. 6, pp. 1413-1421, 2016.
- [15] A. Capitaio Patrao, "On the aerodynamic design of the boxprop," Chalmers University of Technology, Gothenburg, 2018.
- [16] E. Hendricks and M. Tong, "Performance and Weight Estimates for an Advanced Open Rotor Engine," in *48th AIAA/ASME/SAE/ASEE Joint Propulsion Conference and Exhibit*, Atlanta, GA, United States, 2012.
- [17] R. Liebeck, "Design of the Blended Wing Body Subsonic Transport," *Journal of Aircraft*, vol. 41, no. 1, pp. 10-25, 2004.
- [18] A. Lundblad and T. Grönstedt, "Distributed propulsion and turbofan scale effects," in *ISABE 2005*, Munich, Germany, 2005.
- [19] H.-J. Steiner, A. Seitz, K. Wieczorek, K. Plötner, A. T. Isikveren and M. Hornung, "Multi-disciplinary design and feasibility study of distributed propulsion systems," in *ICAS 2012*, Canberra, Australia, 2012.
- [20] EASA, "Sustainable aviation fuels," [Online]. Available: <https://www.easa.europa.eu/eaer/climate-change/sustainable-aviation-fuels>. [Accessed 17 September 2019].
- [21] R. H. Moore et al., "Biofuel blending reduces particle emissions from aircraft engines at cruise conditions," *Nature*, vol. 543, pp. 411-426, 2017.
- [22] G. D. Brewer, *Hydrogen Aircraft Technology*, Boca Raton, FL, United States: CRC Press, 1991.
- [23] Zunum Aero, "Zunum Aero," [Online]. Available: <https://zunum.aero/>. [Accessed 17 September 2019].

- [24] Wright Electric, "Wright Electric," [Online]. Available: <https://weflywright.com/>. [Accessed 17 September 2019].
- [25] Heart Aerospace, "Heart Aerospace," [Online]. Available: <https://heartaerospace.com/>. [Accessed 17 September 2019].
- [26] Pipistrel Aircraft, "Alpha Electro - Pipistrel Aircraft," [Online]. Available: <https://www.pipistrel-aircraft.com/aircraft/electric-flight/alpha-electro/>. [Accessed 17 September 2019].
- [27] L. Dray, "Modelling the transition to a more electric aviation system," 17 May 2018. [Online]. Available: http://goldfinger.utias.utoronto.ca/~IWACC5/IWACC6/Lynnette_Dray.pdf. [Accessed 25 September 2019].
- [28] D. Poll, "On the effect of stage length on the efficiency of air transport," *The Aeronautical Journal*, vol. 115, no. 1167, pp. 273-283, 2011.
- [29] J. Green, "Air Travel – Greener by Design. Mitigating the environmental impact of aviation: Opportunities and priorities," *The Aeronautical Journal*, vol. 109, no. 1099, pp. 361-416, 2005.
- [30] L. Larsson, "Analysis of concepts to reduce the environmental impact of aviation: high propulsive efficiency engines and contrail avoidance," Chalmers University of Technology, Gothenburg, Sweden, 2014.
- [31] European Commission, "EU Emissions Trading System (EU ETS)," [Online]. Available: https://ec.europa.eu/clima/policies/ets_en. [Accessed 17 September 2019].
- [32] ICAO, "Carbon Offsetting and Reduction Scheme for International Aviation (CORSA)," [Online]. Available: <https://www.icao.int/environmental-protection/CORSA/Pages/default.aspx>. [Accessed 17 September 2019].
- [33] Statens offentliga utredningar, "En svensk flygskatt SOU 2016:83," Regeringskansliet, Stockholm, Sweden, 2016.
- [34] Statens offentliga utredningar, "Biojet för flyget. SOU 2019:11," Regeringskansliet, Stockholm, Sweden, 2019.
- [35] H. Grieb, Projektierung von Turboflugtriebwerken, Basel, Switzerland: Birkhäuser Verlag, 2004, pp. 170-251.

- [36] H. Saravanamuttoo, H. Cohen, G. Rogers and P. Straznicky, *Gas Turbine Theory*, 6 ed., Pearson Education, 2009.
- [37] T. Grönstedt, "Development of methods for analysis and optimization of complex jet engine systems," Chalmers University of Technology, Gothenburg, Sweden, 2000.
- [38] J. Young and R. Wilcock, "Modeling the Air-Cooled Gas Turbine: Part 2 - Coolant Flows and Losses," *Journal of Turbomachinery*, vol. 124, no. 2, pp. 214-222, 2002.
- [39] R. Wilcock, J. Young and J. Horlock, "The Effect of Turbine Blade Cooling on the Cycle Efficiency of Gas Turbine Power Cycles," *Journal of Engineering for Gas Turbines and Power*, vol. 127, no. 1, pp. 109-120, 2005.
- [40] G. Wilfert, J. Sieber, A. Rolt, N. Baker, A. Touyeras and S. Colantuoni, "New environmental friendly aero engine core concepts," in *ISABE 2007*, Beijing, China, 2007.
- [41] J.Korsia and G. Spiegeler, "VITAL - European R&D programme for greener aero engines," in *ISABE 2007*, Beijing, China, 2007.
- [42] E. Onat and G. Klees, "A method to estimate weight and dimensions of large and small gas turbine engines," NASA, 1979.
- [43] M. Sammak, M. Thern and M. Genrup, "Reduced order through-flow design code for highly loaded, cooled axial turbines," in *Proceedings of the ASME Turbo Expo 2013: Power for Land, Sea and Air*, San Antonio, TX, United States, 2013.
- [44] Airbus, "Getting To Grips with Aircraft Performance," Blagnac, France, 2002.
- [45] J. Kurzke, "Modeling the Thrust Management of Commercial Airliners," in *ISABE 2013*, Busan, South Korea, 2013.
- [46] W. James and P. O'Dell, "Derated Climb Performance in Large Civil Aircraft," in *2005 Boeing Performance and Flight Operations Engineering Conference*, 2005.
- [47] H. Ekstrand, R. Avellán and T. Grönstedt, "Derated Climb Trajectories for Subsonic Transport Aircraft," in *ISABE 2009*, 2009.

- [48] N. Daidzic, "Jet engine thrust ratings," *Professional Pilot*, pp. 108-112, September 2012.
- [49] A. Linke-Diesinger, *Systems of Commercial Turbofan Engines: An Introduction to Systems Functions*, Springer, 2008.
- [50] S. L. Dixon and C. A. Hall, *Fluid Mechanics and Thermodynamics of Turbomachinery*, 7 ed., Butterworth-Heinemann, 2014.
- [51] European Aviation Safety Agency, "ICAO Aircraft Emissions Databank," [Online]. Available: <http://www.easa.europa.eu/document-library/icao-aircraft-engine-emissions-databank>. [Accessed 2019].
- [52] A. Lundbladh, Specialist whole engine, GKN Aerospace, *Personal communication*, 2015.
- [53] P. de la Calzada, "Low pressure turbines design," Von Karmán Institute, Sint-Genesius-Rode, Belgium, 2003.
- [54] S. Smith, "A simple correlation of turbine efficiency," *Journal of the Royal Aeronautical Society*, vol. 69, pp. 467-470, 1965.
- [55] S. Tosserams, M. Kokkolaras, L. Etman and J. Rooda, "A Nonhierarchical Formulation of Analytical Target Cascading," *Journal of Mechanical Design*, vol. 132, no. 5, 2010.
- [56] D. P. Bertsekas, *Nonlinear programming*, Athena Scientific, 1999.
- [57] L. H. J. Smith, "Wake Ingestion Propulsion Benefit," *Journal of Propulsion and Power*, vol. 9, no. 1, 1993.
- [58] M. Drela, "Development of the D8 transport configuration," in *29th AIAA Applied Aerodynamics Conference*, Honolulu, HI, United States, 2011.
- [59] NASA. [Online]. Available: https://www.nasa.gov/images/content/453736main_mit_d8-5_original_full.jpg. [Accessed 20 September 2019].
- [60] J. Hileman, Z. Spakovszky, M. Drela and M. Sargeant, "Airframe design for "silent aircraft", " in *45th AIAA Aerospace Sciences Meeting and Exhibit*, Reno, NV, United States, 2007.

- [61] L. Wiart and C. Negulescu, "Exploration of the Airbus "Nautilus" engine integration concept," in *31st Congress of the International Council of the Aeronautical Sciences*, Belo Horizonte, Brazil, 2018.
- [62] J. Bijewitz, A. Seitz, A. T. Isikveren and M. Hornung, "Multi-disciplinary design investigation of propulsive fuselage aircraft concepts," *Aircraft Engineering and Aerospace Technology: An International Journal*, vol. 88, no. 2, pp. 257-267, 2016.
- [63] A. Seitz, "Concept validation study for fuselage wake-filling propulsion integration," in *ICAS 2018*, Belo Horizonte, Brazil, 2018.
- [64] C. L. Bowman, J. L. Felder and T. V. Marien, "Turbo- and Hybrid-Electrified Aircraft Propulsion Concepts," in *AIAA/IEEE Electric Aircraft Technologies Symposium*, Cincinnati, 2018.
- [65] A. Betz, "Interference Between Propeller and Vehicle: The Ducted Propeller," in *Introduction to the Theory of Flow Machines*, New York, NY, United States, Pergamon, 1966, pp. 215-217.
- [66] A. Rolt and J. Whurr, "Optimizing Propulsive Efficiency in Aircraft with Boundary Layer Ingesting Distributed Propulsion," in *ISABE 2015*, Phoenix, AZ, United States, 2015.