



A Method of Reducing Mutual Coupling Using an Extra Coupling Path

Downloaded from: <https://research.chalmers.se>, 2026-04-04 10:34 UTC

Citation for the original published paper (version of record):

Chen, L., Zhang, T., Mansouri Moghaddam, S. et al (2019). A Method of Reducing Mutual Coupling Using an Extra Coupling Path. 13th European Conference on Antennas and Propagation, EuCAP 2019

N.B. When citing this work, cite the original published paper.

A Method of Reducing Mutual Coupling Using an Extra Coupling Path

Lei Chen^{1,2}, Tianling Zhang^{1,2}, Sadegh Mansouri Moghaddam¹, Ashraf Uz Zaman¹, Jian Yang¹

¹ Department of Electrical Engineering, Chalmers University of Technology, Gothenburg, Sweden, lei.chen@chalmers.se, jian.yang@chalmers.se

² National Key Laboratory of Antennas and Microwave Technology, Xidian University, Xi'an, China

Abstract—A method of reducing mutual coupling for a large-scale array with the wideband and beam steering characteristics is proposed in this work. An extra coupling path is intentionally introduced to reduce the mutual coupling among adjacent radiating elements. A millimeter wave array is used to verify the proposed method. The simulation results show that the mutual coupling between adjacent elements can be reduced to below -15 dB over the band of 19-39.5 GHz and this concept is viable even for the beam steering angle range of $\pm 45^\circ$.

Index Terms—Mutual coupling suppress, large-scale array, wideband, beam steering, millimeter wave.

I. INTRODUCTION

Multiple-input-multiple-output (MIMO) antenna systems have been widely considered in modern communication system [1]. However, the mutual coupling between elements is a common problem for the large-scale arrays, which will affect the beamforming function, increase the active reflection coefficient with beam steering and result in highly correlated information channels and deterioration of the efficiency [2].

Various decoupling techniques have been proposed to reduce or compensate for the mutual coupling effect, such as EBG (electromagnetic bandgap) structures [3], coupled resonator decoupling networks [4], parasitic antenna element method [5], and couplers [6], [7]. In [8], an array-antenna decoupling surface is used for reducing the mutual coupling in a large-scale array antenna. In [8], an efficient decoupling network is used for wide-angle scanning array. However, these methods have the limitation and not applicable in case of a large-scale array over a wide bandwidth and wide scan angle.

A method of reducing mutual coupling is proposed. An extra coupling path is introduced to suppress the mutual coupling between adjacent elements. This method can be used to reduce the mutual coupling for a large-scale array with the wideband and beam steering characteristics. The simulation results show that the mutual coupling can be reduced below -15 dB over the band of 19-39.5 GHz within the beam steering angle of $\pm 45^\circ$.

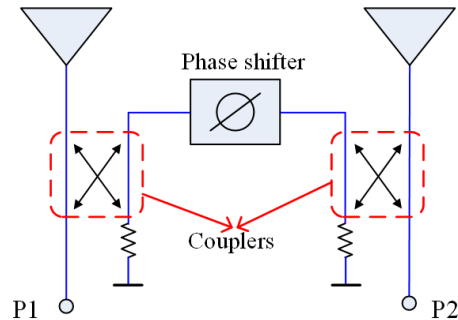

Fig. 1. The structure used for reducing mutual coupling.

II. PRINCIPAL OF THE METHOD

An extra coupling path including two couplers and a phase shifter is introduced to reduce the mutual coupling, as shown in Fig. 1. Part of the energy is coupled into the introduced coupling path. When the coupled power of the introduced path has the same amplitudes and opposite phase with the coupled power via the radiation directly from free space, the total mutual coupling can be completely canceled out. By adjusting the coupling coefficient of the coupler and the phase of the phase shifter, the mutual coupling can be reduced between the equivalent ports P1 and P2 over a wideband optimally.

Based on this structure, the optimization procedure can be summarized as follows:

Step 1: Obtain the active S_{11}/S_{22} and S_{21} of two adjacent elements in the array. The use of the active S-parameter of element in the array can make the proposed method to be used for a large-scale array.

Step 2: Determine the initial value of coupling coefficient and the phase based on the originally amplitude and phase of S_{21} .

Step 3: Build the simulation models of the proposed structure for different beam steering angles. And then do the optimization.

The procedure shown above will make sure that the proposed method fit for mutual coupling reduction for a large-scale array with broadband and beam steering characteristics.

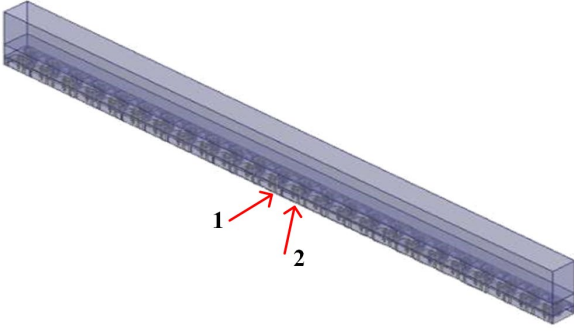

Fig. 2. Simulation model of a 24-element linear array.

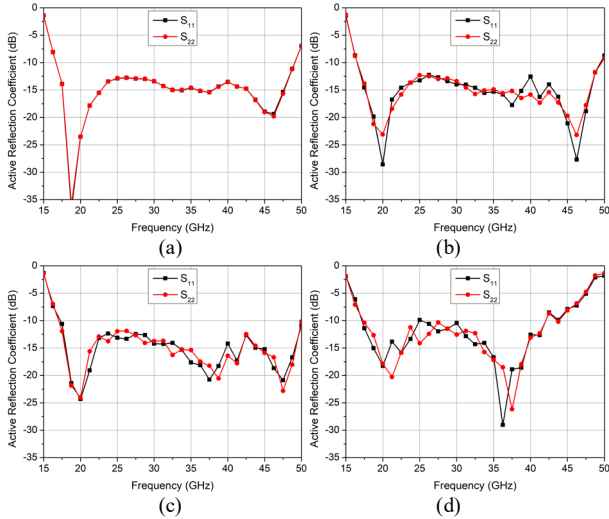

Fig. 3. The active reflection coefficient of two element in the array at different beam steering angles. (a) 0°. (b) 15°. (c) 30°. (d) 45°.

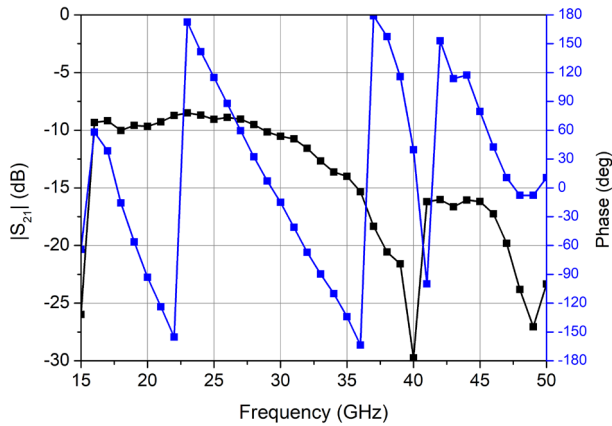

Fig. 4. The simulation results of S_{21} .

A. Array Parameters Extraction

Following the design procedure, a 24-element linear array is simulated to evaluate the mutual coupling between adjacent elements which is shown in Fig. 2.

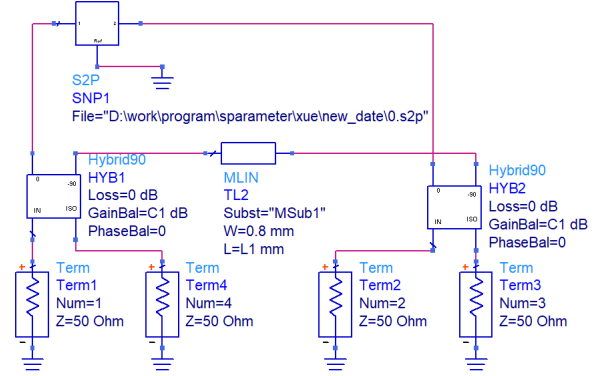

Fig. 5. The simulation model of the proposed structure.

The linear array employs planar bowtie antennas as radiation elements which are similar to magneto-electric dipoles. The excitation structure for the bowtie is r-shaped, which can obtain good impedance matching in a wide frequency range [10], [11].

The S-parameters of two middle elements (1 and 2) are used for the optimization. We extracted the S-parameters of each element of the array to calculate the active reflection coefficients of these two ports at different beam steering angles. It is seen from Fig. 3 that this array can scan to $\pm 45^\circ$ over 17-42 GHz while the active reflection coefficient of two ports are below -10 dB. Shown in Fig. 4 is the amplitude and phase of S_{21} . This array has a strong mutual coupling especially at lower frequency band (around -9 dB over 17-28 GHz).

B. Parameter Calculation

Fig. 5 shows the simulation model built in ADS based on the proposed structure. The S2P model is used to import the calculated S-parameter of two-element antenna array. The transmission line is used to change the phase in the introduced path. Considering the symmetric of the structure, two couplers have the same parameters.

Based on the amplitude and the phase of the S_{21} of originally two-element antenna array, the coupling coefficient C_1 of the couplers and the length L_1 of the transmission line in the introduced path can be calculated.

C. Optimization

Four models for scan angle at 0° , 15° , 30° , 45° are built respectively with the same parameters of couplers and transmission line while the import S-parameters of the antennas are distinct for these different steering angles. Then the optimization has been done to the simulation model to make sure that the proposed structure has good performance of reducing mutual coupling at different beam steering angle without the deterioration of active reflection coefficient.

IV. CONCLUSION

A method of reducing mutual coupling is proposed. An extra coupling path is introduced to eliminate the mutual coupling between adjacent elements. To validate the proposed scheme theoretically, the active S_{11}/S_{22} of the element in a specific array are obtained by a 24-element linear array firstly. Then amplitude and phase of S_{21} are used to determine the initial parameters of the proposed structure. Finally, the optimization has been done for beam steering condition. The simulation results show that the mutual coupling can be reduced to below -15 dB over the band of 19-39.5 GHz within the beam steering angle of $\pm 45^\circ$. This method can be used for mutual coupling reduction of a large-scale array with wideband and beam steering characteristics.

ACKNOWLEDGMENT

This work has been carried out within the Strategic Innovation Program "Smarter Electronics Systems", a joint venture of Vinnova, Formas and Energy Agency, with a grant no. 2017-01881 and the National Natural Science Foundation of China, with a grant no. 61671304.

REFERENCES

- [1] H.Q. Ngo, E.G. Larsson, and T.L. Marzetta, "Energy and spectral efficiency of very large multiuser MIMO systems," *IEEE Trans. Commun.*, vol. 61, no. 4, pp. 1436–1449, Apr. 2013.
- [2] K. Hausmair, P.N. Landin, U. Gustavsson, C. Fager and T. Eriksson, "Digital Predistortion for Multi-Antenna Transmitters Affected by Antenna Crosstalk," in *IEEE Transactions on Microwave Theory and Techniques*, vol. 66, no. 3, pp. 1524-1535, Mar. 2018.
- [3] F. Yang and Y.R. Samii, "Microstrip antennas integrated with electromagnetic band-gap EBG structures: A low mutual coupling design for array applications," *IEEE Trans. Antennas Propag.*, vol. 51, no. 10, pp. 2936–2946, Oct. 2003.
- [4] L. Zhao, L.K. Yeung, and K.L. Wu, "A coupled resonator decoupling network for two-element compact antenna arrays in mobile terminals," *IEEE Trans. Antennas Propag.*, vol. 62, no. 5, pp. 2767–2776, May 2014.
- [5] B.K. Lau and J.B. Andersen, "Simple and efficient decoupling of compact arrays with parasitic scatterers," *IEEE Trans. Antennas Propag.*, vol. 60, no. 2, pp. 464 - 472, Feb. 2012.
- [6] J. Andersen and H. Rasmussen, "Decoupling and descattering networks for antennas," *IEEE Trans. Antennas Propag.*, vol. 24, no. 6, pp. 841–846, Nov. 1976.
- [7] K. Nishimoto, H. Makimura, T. Yanagi, Y. Nishioka, N. Yoneda, and H. Miyashita, "Narrowband-wideband decoupling networks for antenna arrays and excitation distribution control," in *International Workshop on Antenna Technology (iWAT)*, 2018.
- [8] K.L. Wu, C.N. Wei, X.D. Mei, and Z.Y. Zhang, "Array-antenna decoupling surface," *IEEE Trans. Antennas Propag.*, vol. 65, no. 12, pp. 6728-6738, Dec. 2017.
- [9] R.L. Xia, S.W. Qu, P.F. Li, Q. Jiang, and Z.P. Nie, "An efficient decoupling feeding network for microstrip antenna array," *IEEE antennas and wireless propagation letters*, vol.14, pp. 871-874, 2015.
- [10] S.M. Moghaddam, J. Yang, and A.A. Glazunov, "Ultra-wideband millimeter-wave bowtie antenna," in *International Symposium on Antennas and Propagation (ISAP)*. IEEE, 2017, pp. 1-2.
- [11] S.M. Moghaddam, J. Yang, and A.A. Glazunov, "A planar dual-polarized ultra-wideband millimeter-wave array antenna," in *2018 12th European Conference on Antennas and Propagation (EUCAP)*, London, 2018.

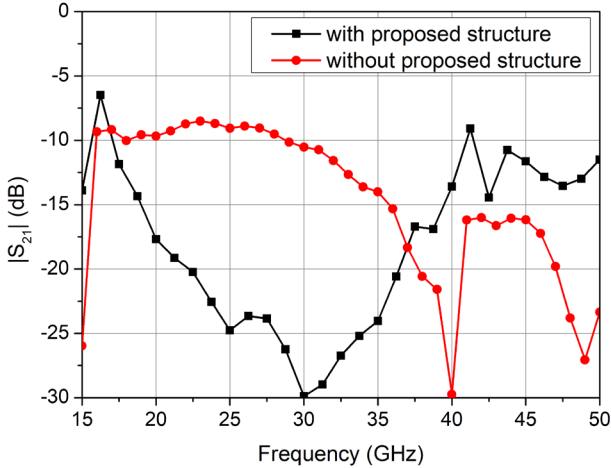

Fig. 6. The simulated mutual coupling results with and without the proposed structure.

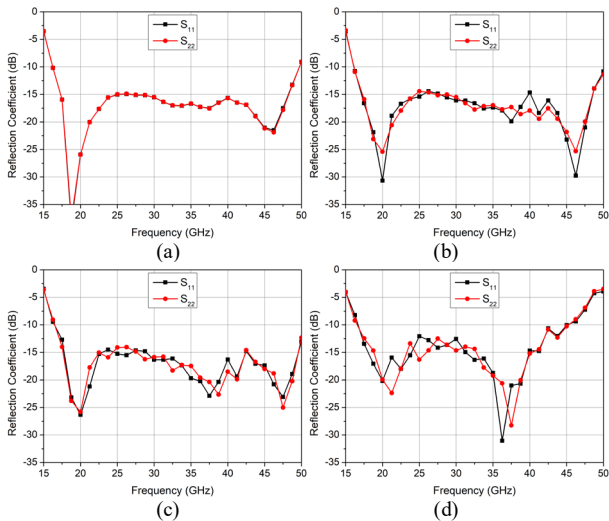

Fig. 7. The reflection coefficient of two equivalent ports at different beam steering angles. (a) 0° . (b) 15° . (c) 30° . (d) 45° .

III. SIMULATION RESULTS

The simulation results of the proposed structure are shown in Fig. 6. Where $C_1=5.55$ dB, $L_1=14.6$ mm. The ϵ_r of substrate is 2.2, the height is 0.254 mm.

It is shown that the coupling between the equivalent ports is below -15 dB over 19-39.5 GHz. The proposed structure produces an improvement for beam steering condition over wideband, especially at the lower frequency. Considering the nonlinear phase and nonuniform amplitude at the higher frequency compared with the lower frequency, the mutual coupling at higher frequency is not reduced to a low level.

Meanwhile, the reflection coefficients are not deteriorating seriously at both ports at different steering angles which are shown in Fig. 7.