

# The GoBiGas Project

Demonstration of the Production of  
Biomethane from Biomass via Gasification





# The GoBiGas Project

## Demonstration of the Production of Biomethane from Biomass via Gasification

Anton Larsson<sup>1</sup>, Ingemar Gunnarsson<sup>1</sup>, Freddy Tengberg<sup>1</sup>

<sup>1</sup>Göteborg Energi AB, Johan Willins gata 3, 401 20 Gothenburg, Sweden

*Tryckinformation*

## Preface

**This report summarizes the experience from the Gothenburg Biomass Gasification (GoBiGas) project, where a first-of-its-kind demonstration plant for the production of 20 MW biomethane via the gasification of biomass.**

**The municipally-owned energy company Göteborg Energi AB was founded in 1846 for the purpose of developing energy solutions for the City of Gothenburg, Sweden. The first service provided was gas street lamps. Since then, Göteborg Energi contributed to the electrification of the city at the end of 19<sup>th</sup> century as well as building an extensive district heating grid. An important driving force in the development of district heating was to provide a sustainable low-emission solution for heating homes in the city. With the same aims, local natural-gas fueled busses were introduced in the 1980s. In the beginning of the 21<sup>st</sup> century, focus was shifted towards biogas as a renewable alternative to natural gas to reduce greenhouse gas emissions. As part of this endeavor, the GoBiGas project was initiated in 2005 to demonstrate the technology and aid development towards commercial biorefineries based on gasification.**

**This report has been produced by Göteborg Energi AB. Its authors are Anton Larsson, Ingemar Gunnarsson and Freddy Tengberg. Valuable contributions and feedback were provided by Claes Breitholtz (Valmet), Staffan Andersson (Göteborg Energi), Henrik Thunman (Chalmers University of Technology) and Christofer Åslund (Göteborg Energi).**

**The GoBiGas project was financed by Göteborg Energi AB and the Swedish Energy Agency. The evaluation of the GoBiGas project was supported by Chalmers University of Technology, Valmet AB, and numerous research projects (listed in Appendix 2) as well as the Swedish Gasification Center (SFC), especially the node focused on indirect gasification (SIGB) for the invaluable cooperation regarding the gasification technology.**

**The personnel at GoBiGas are acknowledged for their tremendous effort and excellent work in getting the plant running and for facilitating all the development and measurements conducted during this project.**



## Sammanfattning

GoBiGas-projektet initierades med syftet att bygga ett industriellt bioraffinaderi och för att demonstrera tekniken för kommersiell produktion av biometan genom förgasning av biomassa, där GoBiGas-anläggningen är den första i sitt slag. I denna rapport summeras erfarenheter, lärdomar och slutsatser från projektets olika faser med målet att göra information om projektet tillgänglig och på så sätt stödja framtida utveckling av kommersiella bioraffinaderier för produktion av avancerade biobränslen.

GoBiGas-anläggningen, som ligger i Göteborg, har en produktionskapacitet på 20 MW biometan och levererar gasen direkt till svenska naturgasnätet. Anläggningen byggdes av det kommunägda energibolaget Göteborg Energi AB med finansiellt stöd från Energimyndigheten. Projektet startade redan 2005 med förstudier och utredningar som så småningom ledde fram till de slutliga teknikvalen och investeringsbeslut 2010. I rapporten beskrivs även projektarbetet fram till driftsättningen 2013. Vidare beskrivs driften och erfarenheter fram tills driften upphörde 2018. Utvärderingen av anläggningen fokuserar på hur den använda tekniken kan kommersialiseras i form av liknande fristående anläggningar med en produktionskapacitet på 100 MW eller större.

Med mer än 12,000 timmars förgasningsdrift har GoBiGas-projektet demonstrerat processens funktion och prestanda. Gaskvaliteten har uppfyllt högt ställda krav med olika råvaror såsom träpellets, flis, bark och returträ. Resultaten visar att en biomassa till biometanverkningsgrad på upp till 70% (baserat på lägre värmevärdet av det torra askfria bränslet) kan uppnås med denna teknik, samtidigt som växthusgas-reduceringsfaktorn för den producerade gasen är över 80% jämfört med bensin/diesel. För att nå denna prestanda är det nödvändigt att torka bränsle, något som även gynnar processens stabilitet och drift. Resultaten visar även att den producerade gasen uppfyller gällande krav inom Europa för injektion av biogas till naturgasnätet, vilket visar att en storskalig produktion av biometan genom denna typ av process ansluten till naturgasnätet är tekniskt möjlig.

GoBiGas-projektet har demonstrerat att denna typ av process kan användas för att på kommersiell skala och med hög verkningsgrad baserad på känd teknik. Framtida utveckling bör fokuseras på en förbättrad kompatibilitet mellan olika processteg samt en förbättrad ekonomisk prestanda. Med rådande processuppställning och nyttjande av GROT som bränsle, uppskattas produktionskostnaden för en kommersiell anläggning på 200 MW vara ca 600 kr/MWh baserat på data från GoBiGas.



## Abstract

In the GoBiGas project, a first-of-its-kind industrial scale biorefinery was built for the purpose of demonstrating and enabling commercial production of biomethane from woody biomass via gasification. This report summarizes the experience, lessons learnt and conclusions from the feasibility study, construction and operation of the GoBiGas plant with the aim of supporting development of commercial production plants for advanced biofuels.

The GoBiGas plant, with a production capacity of 20 MW of biomethane gas delivered to the natural gas grid in Sweden, is located in Gothenburg. The plant was built by Göteborg Energi AB with the support of the Swedish Energy Agency and the project was initiated in 2005. This report includes a summary of the main contractors and technology choices made during the project and describes the commissioning of the plant in 2013. The report also describes experience gained from the operation and evaluation of the process until it was decommissioned in 2018. The evaluation of the plant focused on how the technology can be commercialized through construction of a similar stand-alone plant with a production capacity of 100 MW or more.

With more than 12,000 hours of operation, the GoBiGas project has demonstrated how the quality of the product gas from a biomass gasifier can be controlled using a range of different feedstocks including bark, wood pellets, wood chips and recovered wood of class A1. Results show that a biomass to biomethane efficiency of up to 70% (based on the lower heating value of the dry ash-free fuel) is possible and that biomethane with a reduction factor for greenhouse gas emissions of over 80% can be produced with this technology. To reach such high efficiency, it is necessary to dry the feedstock and this also benefits the stability of the process. Results also show that gas quality fulfils the European standard for injection into the natural gas grid, thereby showing that large scale production of biomethane delivered by injection to the natural gas grid is possible.

The project has demonstrated that this type of process can be applied on a commercial scale with high performance using known technology and that future development should involve improved compatibility between different process steps as well as improved economic feasibility of production. With the current process setup and using forest residues as feedstock, the production cost for a plant with a 200 MW production capacity, estimated based on the economic data from GoBiGas, corresponds to about SEK 600/MWh.



## List of Content

1	Background and Driving Force of the Project .....	1
1.1	Feasibility study .....	1
1.2	Pre-engineering.....	4
1.3	Performance Goal for the GoBiGas Plant .....	4
1.4	Key decisions for the GoBiGas project .....	5
2	Plant Design and Project Execution .....	7
2.1	Timeframe: Forecast and Actual .....	7
2.2	Site-Related Project Aspects .....	8
2.3	Plant Materials .....	10
2.4	Project Organization.....	11
2.5	Main Contractors .....	11
2.6	Description of the Main Process Components.....	13
2.7	Design Cases .....	15
2.8	Process Control, Automation and Data Collection .....	15
2.9	Summary of Investment Costs.....	16
2.10	Parallel Research Activities .....	18
3	Demonstration of Biogas Production via Gasification .....	19
3.1	Operation of the GoBiGas Plant.....	19
3.2	Major Lessons learnt.....	21
3.3	Evaluation of the Performance of the GoBiGas Process .....	32
3.4	Consumables, Waste Products and Emissions .....	39
3.5	Greenhouse Gas Emission Reduction Factor and Carbon Efficiency.....	40
3.6	Quality of the Produced Biomethane.....	41
4	Commercial Production of Advanced Biofuels via Gasification .....	43
4.1	Technical Performance.....	43
4.2	Investment and Production Cost.....	46
5	Concluding Remarks .....	49
6	References .....	51
	Appendix 1 – Experiences and lessons learned.....	I
	Appendix 2 – Research Projects Connected to GoBiGas .....	XXVI
	Appendix 3 – List of Key Personnel, from January 2011 until May 2018.....	XXX
	Appendix 4 – Performance Parameters.....	XXXII
	Appendix 5 – Gas Quality and Performance over Time.....	XXXIV



# 1 Background and Driving Force of the Project

**GoBiGas (Gothenburg Biomass Gasification project)** started with internal discussions at Göteborg Energi in 2005, and the driving force was the need for more biofuels, particularly in the transport sector. Göteborg Energi and other energy companies in Sweden had been forerunners in developing the production of biogas as a transport fuel. As early as the 1980s, buses and cars fueled with natural gas were introduced in the City of Gothenburg with the aim of reducing local air pollution. At the beginning of the 21<sup>st</sup> century, political discussions in Sweden focused intensely on environmental issues, in particular emissions from the use of fossil fuels. Economic drivers used to reduce emissions were tax-exemption for biofuels and high taxes on fossil fuels in Sweden, especially transport fuels, and this promoted the early development of the market for biogas.

Göteborg Energi realized that biogas was an excellent fuel being both efficient and environmentally friendly with the potential to meet most of the coming requirements including low emissions of greenhouse gases. The only drawback identified was the relatively low amount of available raw materials suitable for biogas production through digestion, with an estimated potential of up to 10 TWh at the time (2006). With a projected demand for biogas of 80–90 TWh in the road transport sector, additional feedstock was required. Through gasification, biomass can be converted into various products, such as biogas, thus increasing the potential feedstock for biogas significantly. The aim of the GoBiGas project was to utilize forest residue to produce biogas. Forest residuals are an ample resource in Sweden, not fully exploited even though there is a well-developed market for forest residuals for energy production. The potential for biogas production via gasification of forest residuals was at that time widely discussed and some estimations showed a potential of up to 70 TWh/year. In 2018, the production potential based on gasification of residues was estimated to be at least 20 TWh/year, which is still very significant.

At the beginning of the 21<sup>st</sup> century, Göteborg Energi was promoting the development of gas-fueled vehicles and the distribution of biogas as well as natural gas as transport fuel. At that time, the GoBiGas project was a perfect fit for Göteborg Energi and a major step towards a future energy sector less dependent on fossil fuel.

## 1.1 Feasibility study

After internal discussions and discussions with key persons at Chalmers University of Technology, a draft goal for a feasibility study was settled:

*“to investigate the possibilities of building a big plant for biogas production from forest residues including gasification and synthesis processes. The final product should meet the quality standards of natural gas and thus be possible to distribute in the gas grid mixed with natural gas.”*

At the beginning of 2006, a formal feasibility study project was begun with the aim of investigating possible technologies to give a clear idea of technical data and performance of a future plant. The study was performed in cooperation with external experts (TPS in Sweden and ETC in the Netherlands) to establish a platform for future decisions and planning. Furthermore, different plant sites, gasification technologies and environmental issues related to such a plant were investigated in the feasibility study (summarized July 2006).

In summary, the study showed that building a 100 MW biomethane production plant based on the gasification of forest residues was feasible. It would be the first of its kind, both in size and process layout. Different biomass gasification technologies referred to as *oxygen blown fluidized bed* and *indirect dual fluidized bed* gasification were compared. Both technologies showed the potential to enable high efficiency and reliable operation, referring to other gasifiers in operation where most

relevant plant at the time was the Güssing plant in Austria [1] and the Värnamo plant in Sweden [2]. The efficiency from biomass to biogas was estimated to be over 60% on an energy basis, and the gas cleaning technology was identified to be a key technology.

A suitable site was identified at Rya where the first oil harbor in the Gothenburg region was located. At this site, Göteborg Energi already had several established plants for district heating and electricity production. A future site at Rya for GoBiGas would have the advantage of being close to the following infrastructure:

- Gas grids with 4 and 35 bar pressure
- Electrical grid
- District heating grid
- Quay for delivery of biomass
- Railway for delivery of biomass
- Other production plants which could be coordinated in operation with the new plant

From an environmental point of view, disadvantages with this site relating to transport, noise and odors from biofuel handling were identified as a consequence of the proximity of densely populated areas and a protected natural habitat. Additional focus was therefore given to these aspects throughout the project.

The goal was to construct a commercial plant where the potential profitability could be estimated by comparing the production cost of the biogas to the anticipated price of vehicle gas. The preliminary calculations showed that gas could be produced at a competitive cost level. Figure 1.1 shows the historical price levels of gasoline up to 2006 as well as the projected development of the price levels of both gasoline and vehicle gas in Sweden, presented as a high and a low case to include potential risks. Note that this analysis was conducted prior to the big drop in fossil fuel prices in 2014. At the time (2006) the business case was deemed very promising.

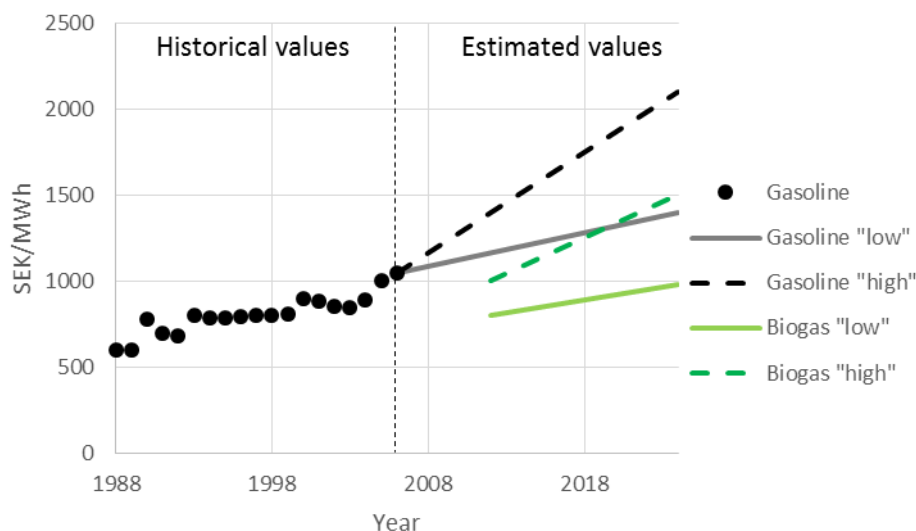

Figure 1.1: Estimated development gasoline and biogas prices development made 2006.

During this early project stage, the concept of distribution and trade with tax-free *green gas* was not yet established. This tax exemption was identified as essential for making the project economically feasible and to carry on with the investment. In 2011, this question was clarified and trade with *green gas* was established, and was a significant advantage for the project.

A risk analysis for the project was conducted during the feasibility study and the following four major risks were identified:

- *Financing* could not be handled by Göteborg Energy.
- The production cost for the gas could be higher than expected.
- Procurement could be difficult since it would not be possible to find one company with the capacity and expertise to deliver the complete plant.
- The technology was possibly not mature enough to be operational at a 100 MW scale.

The purpose of the GoBiGas project was to produce a fuel for the transport sector that was environmentally friendly and which contributed with very low emissions of greenhouse gases from fossil sources. Therefore, a comprehensive well-to-wheel (WTW) analysis was conducted to ensure the biogas could be produced in line with these criteria.

The WTW analysis included the energy losses and emissions of CO<sub>2</sub>-equivalents (CO<sub>2,eq</sub>) at each and every step from collecting the raw material in the forest (the well), transporting it to the plant and through all process steps until final consumption of the gas by vehicles (the wheel). This included the pressurization and transport of the gas through the gas grid to the fueling stations. Two scenarios based on the chosen feedstock for the GoBiGas process were analyzed: 1) wood pellets and 2) woodchips/forest residues. Results from the WTW analysis are summarized in Fig. 1.2. It was determined that very low emissions of CO<sub>2,eq</sub> can be expected from the use of both wood pellets and forest residues. Results were also compared to a range of alternatives for vehicle propulsion including the use of alternative biofuels, fossil fuels and electrical propulsion, indicating that the concept is competitive even compared to electric vehicles using a Nordic mix of electricity for charging. This showed that the production chain from biomass to biogas-fueled vehicles *via* the GoBiGas process could be expected to meet even the very toughest requirements envisaged for tax-exempt renewable vehicle gas.

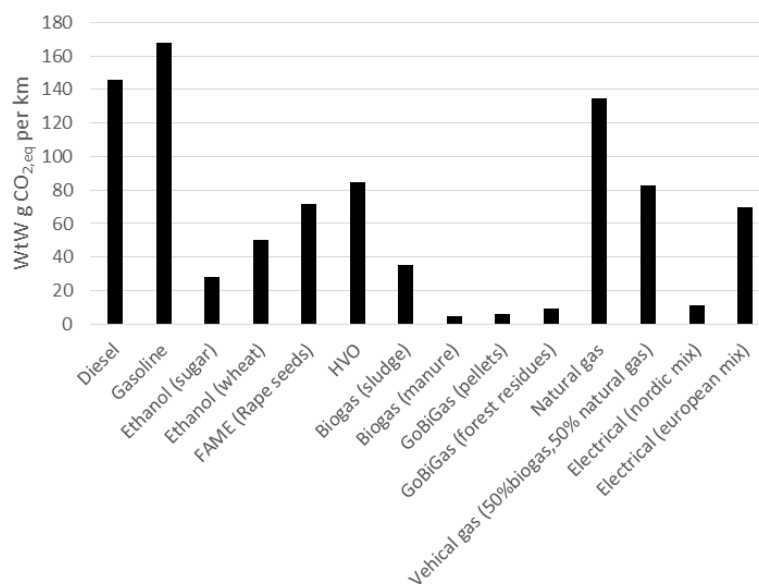

Figure 1.2: Well-to-wheel analysis comparing different propulsion alternatives including biogas from GoBiGas as estimated 2011.

All in all, the results of the feasibility study were regarded as very promising and the next step was to start pre-engineering work to analyze (in more detail) the technical, environmental and economic conditions for a future plant.

## 1.2 Pre-engineering

During pre-engineering (late 2006 and 2007), several possible technical solutions were considered. The conclusion was that there was no available technology on the market meeting the goal to produce 100 MW of biogas from forest residues in a stand-alone plant. It would therefore be a very high risk to invest in such a plant both from a technical and economical point of view. The technology considered most promising was indirect gasification (Repotec) in combination with methanation in a fluidized bed (under development by CTU). However, none of these could be scaled up and delivered as a 100 MW plant. It was therefore determined that the project had to be split into two phases where the technology was first demonstrated in a 20 MW plant in phase 1 before constructing the commercial plant in phase 2. As described further later in this report, changes in the energy market made it economically unviable to continue with phase 2. Thus, this report is restricted to the experience from phase 1 of the GoBiGas project and the 20 MW demonstration plant.

During 2008 and 2009, the technology was further analyzed together with several companies on the market and different alternatives were discussed. It became clear that there were just a few companies and technologies available on the market if high risks were to be avoided even at the 20 MW scale. It was also clear that Göteborg Energi had to take a major responsibility in developing the technology to enable a commercial production plant.

## 1.3 Performance Goal for the GoBiGas Plant

After the feasibility study and pre-engineering phases, an overview of available technology and its performance was compiled, which enabled the establishment of performance goals for the future plant. The idea was to have tough but realistic goals for the most important performance criteria. Those criteria were presented at the time of our application for government funding from the Swedish Energy Agency in 2009. They are as follows:

- **Production capacity 20 MW** – The size of the plant was decided to enable a realistic demonstration of the technology with all its possibilities and consequences. Gas quality had to meet the requirements of the natural gas grid to be accepted by the operator and customers connected to the grid.
- **Efficiency of the biomass to bio-methane conversion would be 65% calculated on an energy basis.** – The efficiency goal is quite optimistic but realistic when based on a combination of the Repotec gasification technology (tested in Güssing) and conventional methanation. This performance goal is important since it determines how much fuel can be produced from the limited biomass resources.
- **Total energy efficiency over 90%** – This value included recovered energy for other purposes such as electricity production or district heating. GoBiGas phase one is not big enough to make generating electricity feasible, but waste heat is recovered as district heating and as a heat source for heat pumps. This was possible as the plant is situated close to the heating network and production plants.
- **Availability of 8,000 hours/year** – This is a very tough target for a demonstration plant but also very important for the operation economy for a fully commercial production plant. This target is comparable with experiences from commercial process industries.

#### 1.4 Key decisions for the GoBiGas project

A summary of the major decisions leading up to and during the GoBiGas project is given in table 1.1. The final decision to stop the ongoing sales process and the demonstration at GoBiGas was taken by the board of Göteborg Energi in Mars 2018 mainly due to economic reasons. The plant has been conserved and experience is summarized in this report.

Table 1.1:

<b>Year</b>	<b>Forum</b>	<b>Decision</b>
2006	Management (Göteborg Energi AB)	Start of pilot study of Biogasification and biogas production 100 MW
2008	Management	Continued investigation of GoBiGas in two phases GoBiGas 1 - 20MW, GoBiGas 2 - 80 MW
2009	Swedish Energy Agency	Funding SEK 222 million from the Swedish state
2010	European commission	Approval of funding from the Swedish state
2010	Board of Göteborg Energi AB	Investment decision
2011	Board of Göteborg Energi AB	Extended investment decision
2012	European commission	Approval of NER300 application from Göteborg Energi concerning Phase 2 of GoBiGas
2015	Board of Göteborg Energi AB	Cancel the plans for Phase 2 and turn down the NER 300 contribution
2017	Board of Göteborg Energi AB	Decision to sell GoBiGas 1
2018	Board of Göteborg Energi AB	Conservation of the GoBiGas plant and aborting the demonstration



## 2 Plant Design and Project Execution

### 2.1 Timeframe: Forecast and Actual

The project was divided into five sub-projects:

1. Ground Preparation
2. Gasification (Metso/Valmet – EPC/Partnering Agreement)
3. Methanation and Auxiliary Systems (HTAS/Jacobs – EPCM)
4. OSBL – Outside Battery Limits
5. Feedstock Handling (Forest Residue/Wood Chips)

The project execution phase covered sub-projects 2–5, whereas sub-project 1 was executed with restricted funding in parallel with the feasibility study and technical selection activities, see Fig. 2.1.



*Figure 2.1: Photomontage of the GoBiGas plant from the planning phase of the project (left) located tight next to an existing boiler and the protected Rya forest, and picture from the site preparation.*

Even though the order for the gasification unit was placed with Metso Power AB (later Valmet AB), via a partnering contract, on December 22, 2010, the project execution phase is considered to have started on March 1, 2011. During this month the official kick-off with Jacobs Process – the EPCM contractor – took place and hence engineering initiated. The main milestones in the project execution phase and their planned versus actual dates are summarized in Table 2.1.

*Table 2.1: Milestones in the Project execution phase*

<b>Milestone</b>	<b>Planned</b>	<b>Actual</b>
M0. Ground preparation.	Mid, 2011	Mid, 2011
M1. Completed construction works, gasification	October 15, 2012	October 30, 2012
M2. Completed start-up, gasification	January 3, 2013	November 20, 2013
M3. Completed construction works, methanation	November 2, 2012	December 8, 2012
M4. Completed start-up, methanation	February 27, 2013	December 20, 2014
M5. First biomethane delivery to the gas grid	May 1, 2013	December 22, 2014

The milestones for completed construction and plant commissioning were in line with the project schedule. However, start-up of gasification took considerably longer than expected in the project schedule – over twelve months compared to the planned two. Stable operation of the gasifier took almost another full year. Thus, deliveries to the gas grid were delayed by over 20 months, even

though the start-up of methanation was faster than expected – four vs. six weeks. The first gasification took place in November 2013, and stable, continuous gasification was achieved in October 2014. The first delivery to the gas grid was in December 2014.

The main causes for the deviations were related to:

M2: The delay in commissioning of the gasification section was mainly caused by two major process-related challenges: a) tar build-up in the product gas cooler, and b) clogging of the fuel feeding screw that pushes the biomass into the bubbling bed of the gasifier. This is further described below.

M4: The start-up of the methanation plant could not be initiated until gasification was capable of producing a sufficient and continuous flow of syngas. Methanation start-up itself was done in less time than anticipated in the project schedule – four vs. six weeks.

M5: The delay in the first bio-methane delivery to the grid was a direct consequence of item M4 above.

In **Sub-project 2**, gasification, the hand-over was accepted on December 15, 2014, and the final performance test was accepted on April 27, 2016. The final settlement with Valmet included an extended warranty period for the product gas cooler. This was due to the unit having been exposed to higher than design temperatures during the commissioning and start-up period.

In **sub-project 3**, methanation and auxiliary systems, the *final completion certificate* and *acceptance certificate* were both signed by the project and issued to Jacobs on April 30, 2014, from which date the *defects liability period*, of 24 months started.

**Sub-project 4**, OSBL, was executed in parallel with sub-project 3, and involved connecting the plant to internal and external parties such as Göteborg Energi for wood pellets, electricity, natural gas and district heating, Gryaab for cooling water and Swedegas for bio-methane.

**Sub-project 5**, feedstock handling, was executed without installing a feedstock dryer budgeted at SEK 17 million, in order to investigate whether this amount could be saved. A pre-requisite was a continuous and stable supply of wood chips with low humidity. There was uncertainty as to exactly what level of humidity was acceptable for the plant, in particular the feed handling system and gasification. The start-up period, however, demonstrated that the humidity level had to be around or below 20%.

The hand-over from the main contractor of sub-project 5, Bruks AB, was made on August 29, 2016. The warranty period according to the ABA contract with Bruks, was 24 months. The start-up period ran until the end of 2016.

## 2.2 Site-Related Project Aspects

Due to the limited space for the plant and the proximity both to Rya Skog – a nature reserve – and residential areas east of the site, it was necessary to make it an indoor plant. The noise restrictions of the environmental permit necessitated housing the potential noise sources inherent in a process industry. Furthermore, it was unknown whether the plant would cause odor problems. If so, they would be very difficult to eliminate if the plant were located outdoors.

The location of the site had many advantages due to the available infrastructure in the area:

- Connection to district heating via existing piping of Rya VP of Göteborg Energi,
- Supply of cooling water via the neighboring Gryaab site,
- Connection of the produced SNG to the natural gas grid in the immediate vicinity.

The plant was designed for a feedstock of forest residues, such as chipped branches or tree tops. However, for the commissioning and start-up period, the intention was to use wood pellets. The reason being that building the feedstock intake and handling section of the plant had to be postponed until after the commissioning due to limited site space, which necessitated having the temporary facilities, such as storage areas, construction workers' huts etc. in the location intended for the feedstock plant. Furthermore, the site had a favorable location, since Rya HVC – a Göteborg Energi district heating plant running on wood pellets – was located immediately to the west of the plant, thus enabling GoBiGas to connect to its existing feedstock handling and also share its environmental permits.

The consequence & safety study performed by Jacobs during the first few months of detailed engineering indicated unacceptable consequences from a potential explosion in the methanation unit. This was due to the proximity of GoBiGas to a neighboring plant, Rya HVC, and areas of nearby *Rya Skog*, as shown in Fig. 2.2.



Figure 2.2: The GoBiGas plant (green building) and surroundings including the protected Rya forest.

GoBiGas was planned to become a separate company later and as a consequence of this, the proximity of the Rya HVC plant and potential explosion risks, a deeper safety analysis involving computerized fluid dynamics (CFD) modelling by Scandpower (later Lloyd's) in Gothenburg and Oslo. The conclusions of this study necessitated reinforcement of the building with an 80 cm thick blast wall of reinforced concrete on the west side and a substantial reinforcement of the wall between the process and the control room areas of the building. Also, the base plate had to be reinforced along with the introduction of supporting walls in the east-west direction to carry the load of the massive explosion wall on the west side; Fig 2.3. Furthermore, 130 gas detectors and additional emergency ventilation capacity had to be installed for early detection and elimination of an explosive gas leak.



*Figure 2.3: Illustrating the proximity to the neighboring plant Rya HVC and the constructed wall of reinforced concrete.*

The detailed layout engineering also revealed that the available volume of the process building was insufficient to hold all of the plant's equipment. Since it was not allowed to increase the building's footprint, the area had to be extended by two balconies and part of the methanation unit's equipment had to be located on the roof; see Fig. 2.2. Due to both the consequence analysis and the building volume limitation, the layout engineering by Jacobs had to be re-worked several times, causing disadvantages to the engineering of other disciplines.

Initially, the plan was to connect the plant to the local 4 bar distribution grid for natural gas within Gothenburg. However, during the project it was realized that the consumption of gas from the local grid decreased during the summer to a point where there was a risk that biogas production would exceed consumption for long periods. Therefore, a connection to the regional high-pressure grid with a maximum pressure of 35 bar was built instead, in order not to limit the possible operational hours of the plant.

All in all, these circumstances caused pressure on the project time schedule and, perhaps more importantly, led to such considerable extra costs that a significant budget amendment had to be requested; see Investment Costs.

### 2.3 Plant Materials

For the plant, as-built, the following amounts of materials or components were used:

- 5,000 m<sup>3</sup> concrete, 800 tons rebar, 1,300 tons steel structure
- 25 km pipes, 90 km cables
- 130 pumps, compressors, fans, conveyors
- 200 towers, reactors, heat exchangers, tanks and vessels
- 2,500 instruments
- 650 valves

## 2.4 Project Organization

The project organization remained practically unchanged throughout the major part of the project. In the few cases where team members were replaced, it was the result of internal job rotation/promotions within Göteborg Energi or a person leaving the company. Most notably, Åsa Burman, the Project Director, decided to leave Göteborg Energi in October 2013, and was replaced by Freddy Tengberg. The composition of the Project Steering Group shifted over time. Also, the chairmen changed as per the following:

- Anders Hedenstedt      until March 2011
- Anders B. Dahl        March – November 2011
- Bengt Göran Dalman    November 2011 – November 2014
- Andreas Rydbo         December 2014 – September 2015
- David Hellström        October 2015 – December 2016

In all cases except the last, the cause was the previous chairman leaving the company.

During the engineering phase of sub-project 3, Methanation and Auxiliary Systems from March 2011 until the end of 2012, six project team members were located full-time at the offices of Jacobs in Leiden, the Netherlands:

- Staffan Andersson      Process and safety
- Torben Granbom        Instrumentation
- Lars Gustafsson        Mechanical, also *Engineering Manager*
- Per-Ove Jonsson        Procurement
- Henrik Larsson         Mechanical
- Åsa Marbe                Process

The purpose was to facilitate transfer of know-how, ensure that the requirements of the project were included in the design and to mutually define the optimum technical solutions.

## 2.5 Main Contractors

An overview of the main contractors is illustrated in Fig. 2.4. Sub-project 2, Gasification, was constructed by Metso Power AB (now Valmet) in Gothenburg, Sweden, as a complete gasification plant via an EPC contract (*Engineering, Procurement & Construction*). The selected gasification technology came from Repotec GmbH & Co KG, Austria, from whom Metso Power had acquired a technology license. In recognition of the first-of-its-kind nature of the GoBiGas plant, the EPC contract between Göteborg Energi and Metso Power was structured as a partnering contract. As part of the partnership, the contract had a fixed price and a variable price portion. The parties cooperated in negotiating all equipment and construction procurement and the corresponding prices constituted the variable price. The engineering and the technology represented the fixed price portion.



Figure 2.4: Main contractors for the different parts of the project.

The Methanation technology in sub-project 3 came from Haldor Topsoe A/S (HTAS), Denmark. Göteborg Energi signed a license agreement with HTAS and also contracted them for a basic engineering package. Jacobs Process BV of the Netherlands was contracted for the detailed engineering, procurement and construction of both the methanation and the auxiliary systems, i.e. the complete scope of sub-project 3. The contract model was EPCM (*Engineering, Procurement & Construction Management*).

The main contractor for sub-project 5, feedstock handling, was Bruks AB, Arbrå.

Procurement for sub-project 2, gasification, was managed by Metso Power. However, Göteborg Energi had full insight and participated in both the technical evaluations and negotiations in accordance with the terms of the partnering contract.

Procurement for sub-project 3, methanation and auxiliary systems, was made by Jacobs on behalf of Göteborg Energi, i.e. Göteborg Energi was the contractual procurement partner but the procurement process was handled by Jacobs, however with full insight and approval by the project. For the equipment, the number of competing quotations was frequently limited, even though *Tendsign* was used to announce the tenders and request quotations. This was also the case for the major contracts, in particular the major concrete and process building works.

All procurement for sub-project 5, feedstock handling, was made directly by the project (via the Procurement Department of Göteborg Energi). The main contractors for sub-project 5 were the following:

- Feedstock handling equipment and system      Bruks, Arbrå
- Civil works and buildings, feedstock handling      Serneke, Gothenburg

Apart from the contracts specifically tied to specific sub-projects, the main EPCM contractors were the following:

- Steel structure, gasification:      Polimex, Poland (subcontractor of Metso/Valmet)
- Piping and mechanical, gasification:      SK Licenssvets, Gothenburg (subcontractor of Metso/Valmet)
- Civil works and process building:      Veidekke, Gothenburg
- Steel structure, methanation:      RijnDijk, The Netherlands
- Piping and mechanical, methanation:      Metalvar, Slovenia
- Electrical and instrumentation, whole plant      WWV, Germany
- HVAC, process building:      Ventilationsgruppen, Gothenburg
- Insulation and heat tracing, methanation:      Hertel, Lithuania

## 2.6 Description of the Main Process Components

A schematic overview of the GoBiGas process is presented in Fig. 2.5 where the major process steps are indicated. The gasifier at GoBiGas is a dual fluidized bed (DFB) gasifier. The fuel is fed to the bubbling fluidized bed of the gasification reactor (1 in Fig. 1) where it is devolatilized and partially gasified with steam. The unconverted part of the fuel (part of the char) is transported with the bed material to the combustion reactor (2) where it is burnt to generate heat for the process. The combustor is a circulating fluidized bed and the particles are separated from the flue gases using a cyclone (3). In this way, heat can be transported between the reactors by circulating the bed material without mixing the gases generated in the two reactors. It is thereby possible to produce an energy-rich gas, referred to as product gas, with very low concentrations of nitrogen, making it suitable for synthesis. It is also for this purpose that the fuel is fed via lock hoppers (10) where air is removed.

To sustain process temperature, part of the product gas is burnt in the combustor in addition to the char. Some product gas may also be burnt in the post-combustion chamber (4) used for the destruction of various low calorific off-gases from the synthesis part of the plant and to control flue gas emissions. The flue gases are cooled and cleaned in the flue gas train (9). The product gas is conditioned in several steps; the first step is the product gas cooler (5) where the gas is cooled to between 160–230°C. Then particles are removed in a textile bag filter (6, referred to as the product gas filter) before the gas is scrubbed with rape-methyl-ester (RME), (7) to remove undesired aromatic hydrocarbons, here on referred to as tar. At this point the gas is clean enough for combustion in an internal combustion engine as is done e.g. at the plant in Senden. Up to this point, the GoBiGas and the Senden processes are rather similar but GoBiGas has about twice the thermal capacity of Senden.

To enable synthesis of the gas, remaining aromatic components need to be removed. This is achieved at GoBiGas by using adsorption beds (8) with activated carbon. With the aromatic compounds removed, the gas is compressed to 16 bar (11) required to overcome pressure drop in downstream process steps and deliver the gas to the compressor station connected to the gas grid. First, unsaturated hydrocarbons (olefins) are hydrogenated, organic sulfur components and COS are converted to H<sub>2</sub>S and any chloride trace components are removed (12) before scrubbing the gas using an amine to remove H<sub>2</sub>S and part of the CO<sub>2</sub> (13). Then the gas passes a guard bed (14) that removes trace amounts of sulfur should there be any left in the gas. The molar ratio between H<sub>2</sub> and carbon are adjusted using a water gas shift reactor (15) before the first step of methanation in the pre-methanator (16). The pre-methanator also acts as a reformer for all hydrocarbons heavier than methane. The remaining CO<sub>2</sub> in the gas is removed using an activated amine in a second scrubber system (17). Finally, the gas is synthesized into CH<sub>4</sub> (18) and dried (19) before being fed to the natural gas grid.

More detailed description of operational experiences from GoBiGas is given in Appendix 1.

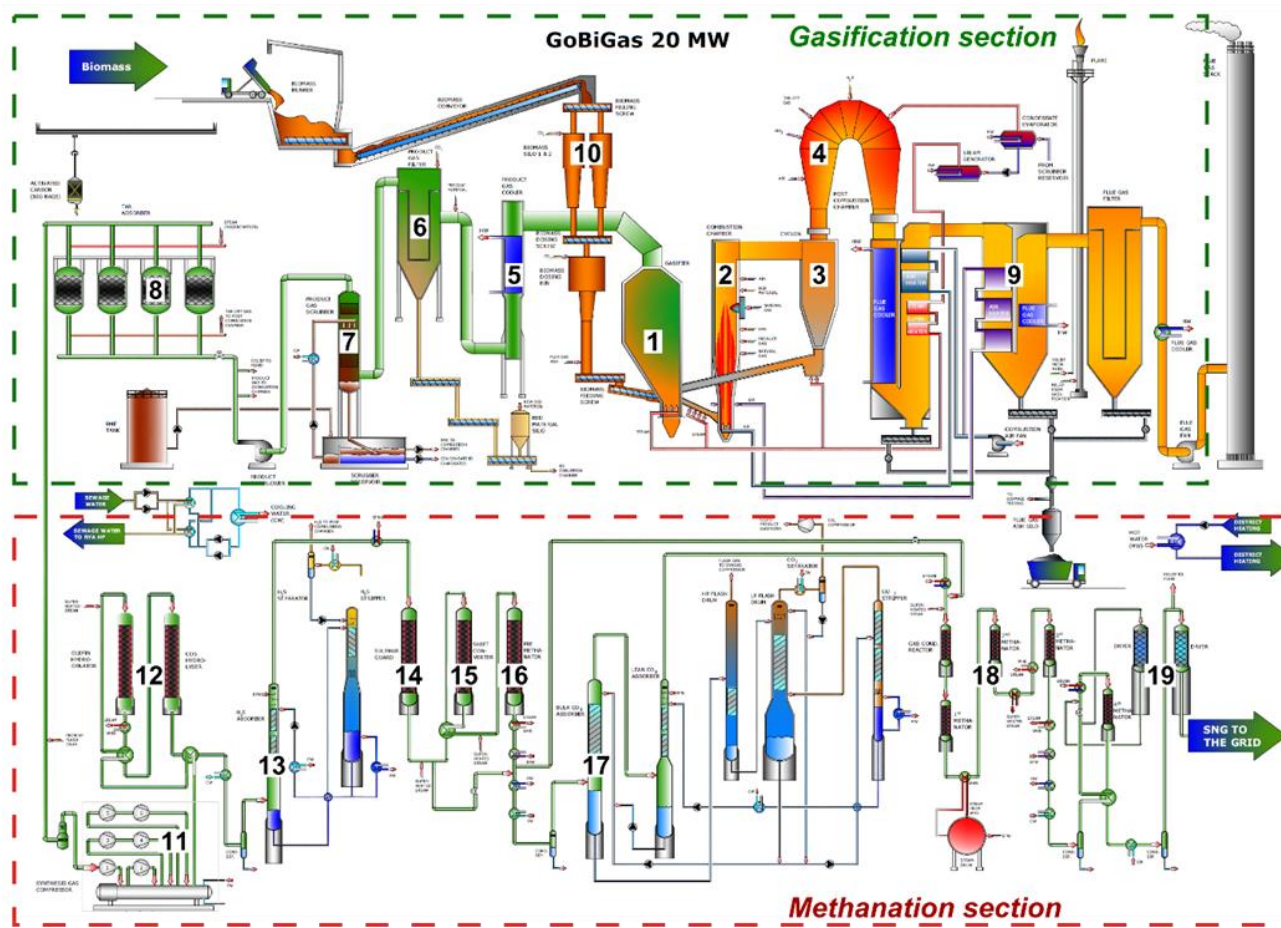

1. Gasifier
2. Combustor
3. Cyclone
4. Post Combustion Chamber
5. Product Gas Cooler
6. Product Gas Filter
7. RME-Scrubber
8. Adsorbent beds
9. Flue Gas Train
10. Lock hoppers
11. Compressor
12. Olefin hydrogenatio
13. H<sub>2</sub>S Scrubber
14. Guard bed
15. Water Gas Shift Reactor
16. Pre-Methanation
17. CO<sub>2</sub> Scrubber
18. Methanation
19. Dryers

Figure 2.5: A Schematic overview of the GoBiGas-plant including a list of the major process steps.

## 2.7 Design Cases

A novelty with the GoBiGas plant was combining the gasification and methanation processes and a key challenge here was estimating valid design data to match the processes together. The composition of the gas after the gasifier and initial gas cleaning with the RME scrubber are listed in Table 2.2.

Table 2.2: Composition of the gas after the RME scrubber (7 in fig. 2.5) estimated for the design of the plant.

Composition	Normal	Maximum	Minimum
CO <sub>2</sub>	21.40	20.40	21.71
CO	20.82	20.74	22.49
H <sub>2</sub>	38.03	39.37	34.46
CH <sub>4</sub>	9.87	8.53	11.39
C <sub>2</sub> H <sub>4</sub> +C <sub>2</sub> H <sub>2</sub>	2.36	2.28	2.40
C <sub>2</sub> H <sub>6</sub>	1.07	1.03	1.09
C <sub>6</sub> H <sub>6</sub> (Benzene)	0.10	0.09	0.10
C <sub>7</sub> H <sub>8</sub> (Toluene)	0.015	0.028	0.015
C <sub>10</sub> H <sub>8</sub> (Naphthalene)	0.034	0.047	0.035
Other Tar	0.001	0.0012	0.001
N <sub>2</sub>	0.83	1.06	0.84
O <sub>2</sub>	0	0.21	0
H <sub>2</sub> S	0.006	0.025	0.006
COS	0.0005	0.0013	0.0005
C <sub>4</sub> H <sub>4</sub> S (Thiophene)	0.001	0.001	0.001
Org. S (as C <sub>2</sub> H <sub>6</sub> S)	0.0015	0.0015	0.0014
NH <sub>3</sub>	0.023	0.15	0.023
HCN	0.001	0.008	0.001

## 2.8 Process Control, Automation and Data Collection

The process control system (PCS) and emergency shutdown system (ESD) are separate units in an integrated system made by Honeywell, Experion PCS system and ESD system Safety Manager. All parts of the PCS and ESD systems are powered via an uninterruptable power system (UPS), which allows operations during a plant power failure. PCS, ESD and Fire and Gas (F&G) can be monitored and controlled from all operator screens in the control room

In the process control system (PCS), the field instruments are wired to marshalling cabinets in the plant. From these cabinets, the signals are transferred via redundant bus cables to the controllers in the instrument room. In general, all parts of the control system, e.g. controllers, servers, bus cables, etc. are redundant with automatic switch-over in case of failure. It is possible to make changes and additions in the PCS system and download during operation.

The ESD Safety Manager consists of four separate PLCs, one each for the gasification, methanation, utilities and F&G detection systems. All signals from field instruments are hard-wired to the ESD PLCs, which are SIL 3 classified. Field instruments connected to the ESD system are separate, normally with separate process connections, from instruments used for control. The Safety Manager has a high level of integrity and may not be changed without a management-of-change procedure and authorization. Only certified personnel are allowed to make changes to this system.

Most critical shutdown and stop functions are collected and hard-wired to a physical safety panel. Examples are the shutdown of large machines, tripping and depressurization of the plant, fire alarms and some overriding functions.

Fire alarms go in most cases directly to local fire department and two active gas alarms above a certain limit will automatically stop and de-pressurize the plant.

Because gasification and methanation were designed by two different contractors, the detailed philosophy for control and safety differed somewhat between the two parts. In the gasification part, too many field signals and control/sequence functions became incorporated into the ESD system. This was a problem when changes were needed or when certain special temporary operating modes were needed. The philosophy regarding maintenance overrides (MOS) and start-up overrides (SOS) for certain field signals was not developed for gasification, while it was in methanation/utilities.

The plant is designed with a high level of automation and with the clear intention of round-the-clock manning by operators. Minimum manning was planned to be two persons, one in the control room and one part time in the field and part time in the control room. The level of attention required and the frequent plant starts and stops made it clear that at least three people were necessary to safely and efficiently operate the plant. However, with stable operation and some increase in automation, the required amount of staff could be reduced with time.

All normal operation activities and normal adjustments can be performed from the control system in the control room. Some start-up and shutdown activities such as operating certain valves must be done in the field, the reason being that these activities are seldom performed. The number of indicating instruments is higher than usual for a power plant or chemical plant. The reason for this was the nature of the plant – a technology demonstrator as well as being a plant for research and development activities where a thorough understanding of the process is vital.

The selected control system has a powerful capacity for collecting and storing all data from the plant. In addition to process values, set points and control valve outputs, the position of valves, shutdown first-out alarms and operator actions are also logged. Data can be stored for years: shorter periods in one-second intervals, for longer periods in intervals of six-minutes or one-hour.

In addition, all process data can be downloaded to the office server system for use in individual computers for miscellaneous data calculations or diagrams. This has proved to be a very useful tool for follow-up, research and development at the plant.

## 2.9 Summary of Investment Costs

The estimated and actual budgets for the GoBiGas project are summarized in Table 2.3. The extraordinary costs caused by the circumstances described under section Project Execution, Consequence & Safety Study, i.e. the necessity to build explosion walls and repeated rework of the plant layout, made it obvious that the project budget from the 2010 investment decision could not be met. To minimize the budget effect, a series of cost reduction workshops were held, both internally and jointly with Jacobs. The aim was to identify more cost-effective solutions in the process, design or equipment. The resulting cost increase after these measures was estimated at SEK 300 million. Thus the project had to request extra funding for this amount from the board of Göteborg Energi. The request was approved in the autumn of 2011, making the project's total budget SEK 1,561 million as presented in table 2.3.

Table 2.3: The budget of 2011 and the actual outcome for the GoBiGas project.

Sub-Project/Cost Item	SEK million			Comments
	Budget <sup>1)</sup>	Actual	Actual - Budget	
1. Ground preparation	25.0	27.1	+2.1	
2. Gasification, Metso/Valmet	315.0	320.2	+5.2	
3. Methanation & aux. systems, EPCM	821.0	899.2	+78.2	See below
4. OSBL	9.0	15.6	+6.6	Increased complexity
5. Feedstock handling	95.6	80.0	-15.6	See Contingency
Project management & interest	245.4	200.9	-44.5	Costs partly booked under each sub-project
Contingency	50.0	1.0+17.0	-32.0	SEK 17 million reserved for possible future feedstock dryer
<b>TOTAL SEK million</b>	<b>1,561.0</b>	<b>1,561.0</b>	<b>+/-0</b>	SEK 1 million of contingency remaining excl. possible feedstock dryer

<sup>1)</sup>Budget after additional approval of SEK 300 million, autumn 2011, see below.

The Swedish Energy Agency, Energimyndigheten, financed SEK 222 million and E.ON provided funding of SEK 44 million. The remaining amount was provided by Göteborg Energi.

The cost follow-up for the engineering of sub-project 3, Methanation and Auxiliary Systems, showed a 2012 budget overrun, mainly due to excessive engineering hours by Jacobs combined with an unfavorable exchange rate. Jacobs' position was that considerable extra engineering was caused by the many revised and additional requirements from the GoBiGas side. However, the project managed to renegotiate the terms of the contract with Jacobs' management such that a cap for the number of billable hours was introduced. This was in exchange for reduced penalties in the event of project delays. In addition, an incentive arrangement was agreed for the major contractual construction works.

Sub-project 5, feedstock handling, was extended in 2016 by engineering and installation of ash output, considered necessary when switching from wood pellets to chipped forest residue. The cost of this extension, SEK 10 million, was managed by using part of the remaining overall project contingency fund. Sub-project 5 itself had no budget allocation for this installation.

## 2.10 Parallel Research Activities

Research activities at the demonstration plant and in parallel with the GoBiGas project have been vital for overcoming some of the initial challenges for the GoBiGas plant. Research and development in gasification received strong support from the Swedish Government, which financed a national center of excellence through the Swedish Energy Agency. The center was initiated in 2011 with the goal of adding the development of the technology for gasification of biomass, being a key technology for reaching the Swedish Government's goal of a fossil-independent vehicle fleet by 2030. The center is called the Swedish Gasification Center (SFC) and is made up of three nodes focusing on different gasification technologies where the node led by Chalmers University of Technology focuses on the Dual Fluidized bed (DFB) gasification technology used in the GoBiGas process. In addition, a cooperation with the Division of Energy Technology at Chalmers had already begun in 2005 to build a pilot gasifier owned by Göteborg Energi in the university heat and power production plant built for research as well as heating the campus area. Gasification work at Chalmers was led by Professor Henrik Thunman, who is also the head of the Division of Energy Technology at Chalmers.

The Chalmers 2–4 MW<sub>th</sub> Gasifier was commissioned in 2007 and was important for the commissioning of the GoBiGas plant. A large number of people were involved and contributed to gasification-related work at Chalmers, which was summarized in 2018 by H. Thunman [3]. The construction of the Chalmers Gasifier enabled parallel investigations and developments in different scales, from fundamental research questions to scale-up issues for the commercialization of the project, Fig. 2.6. The development related to the GoBiGas project focused on enabling a scale-up of the technology to a commercial scale of about 80–100 MW biogas production intended for the second stage of the GoBiGas project (canceled due to lack of profitability).

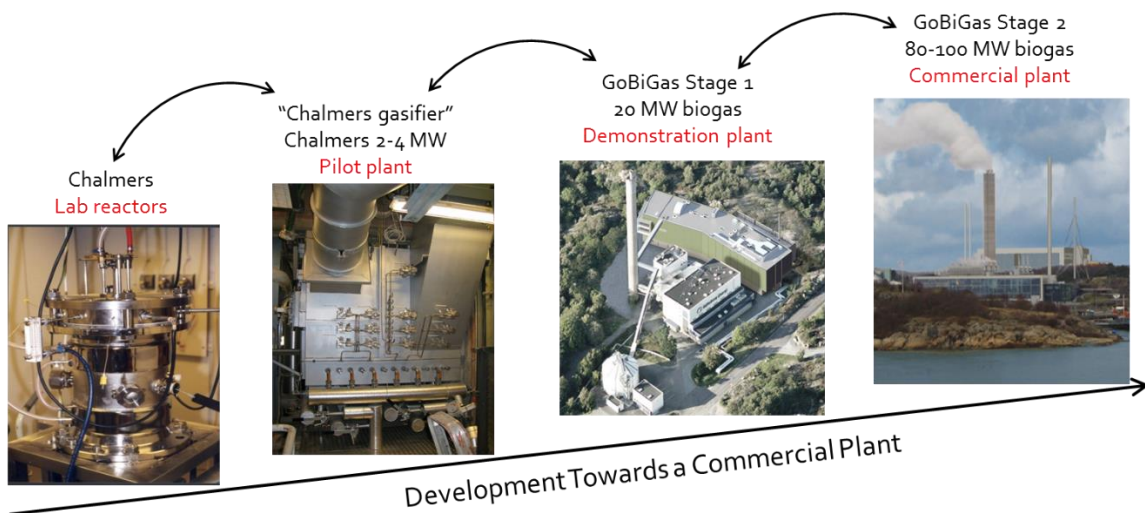

Figure 2.6: Illustration of the different plant scales analyzed in connection to the GoBiGas project. Adapted from H. Thunman et al [4].

There were also a number of research projects that focused on GoBiGas, summarized and briefly described in Appendix 2. Some of the conclusions from these projects and the work at Chalmers were of significant importance during the commissioning of the demonstration plant as well as evaluating the potential for further scale-up and are summarized in the following section, for detailed information, the reader is referred to the specific project reports.

### 3 Demonstration of Biogas Production via Gasification

The major lessons learned from the operation and evaluation of the demonstration plant are summarized in this section while experiences from each specific process step are given in Appendix 1.

#### 3.1 Operation of the GoBiGas Plant

Operation of the GoBiGas gasifier was initiated at the end of 2013 and operating hours are illustrated in Fig. 3.1. The green bars represent the operating hours of each operational period and the blue line represents the accumulated operating hours. During commissioning, wood pellets were used as fuel, which was a significant difference from similar DFB gasifiers, such as the plant in Güssing, operated with chipped fuel. Operating with wood pellets proved a significant challenge at first, as a high level of tar caused fouling problems on downstream equipment. The product gas cooler (5 in Fig. 2.5) clogged quickly and in the beginning only about 10 operating hours were possible before the process was stopped to clean the cooler. In the beginning of 2014, there was a breakthrough regarding limiting the tar yield reached in cooperation with Chalmers and successfully implemented together with Metso. It turns out that operating with ash-poor fuel such as wood pellets, contributed to the challenges and important ash components had to be added, as described below.

With a method in place to limit the tar level, it was possible to begin commissioning the methanation section of the plant. At the end of 2014, biomethane was fed into the natural gas grid for the first time, as shown in Fig. 3.2. At this time, the availability of the plant was instead limited by the fuel feed, caused by pyrolysis of the fuel already in the feeding screw that pushes the fuel in to the bubbling bed of the gasifier.

By new year 2016, the plant was operated nearly continuously with wood pellets, producing around 16 or 17 MW of biomethane, corresponding to 80 to 85% of the design goal of 20 MW. The gas-cleaning step with activated carbon used to adsorb light tar components was identified as a bottleneck that hindered an increase in nominal production. An investigation of this process step resulted in improved operation, removing the bottleneck.

The goal of the GoBiGas plant was to demonstrate production of biomethane using forest residues as fuel, and during the second quarter of 2016 a new fuel reception and handling system was commissioned for this purpose. The first fuel to be tested with the new fuel handling system was chipped stem wood from residual logs (low quality logs not suitable for pulp, paper or material production). The logs were dried outdoors to reduce the moisture content, however, they did not get dry enough to allow the gasifier to produce enough gas to run methanation. As the amount and composition of ash in wood chips is slightly different from wood pellets, the method for controlling gas quality had to be revised. Combined, these problems hindered continuous operation for more than 200 hours and no biomethane was produced during the major part of 2016.

To cope with the problem of high moisture content, pre-dried shredded bark was tested during the second half of 2016. Shredded bark has a low bulk density and unfortunately some sections of the fuel feeding system had to be redesigned to avoid clogging. The bark was dried to about 20% moisture content; however due to logistics in combination with plant availability problems, the dried bark was exposed to outside weather conditions. This caused an increase in the moisture content of the surface layer of the fuel stack while the center of the stack remained dry, causing moisture content to vary a lot and disrupting plant operation.

Due to the moisture-related problems with the operation, it was decided to switch back to wood pellets as fuel in the beginning of 2017 to enable evaluation of the changes made to gas cleaning

and to demonstrate 20 MW production. Some biomethane was produced in the beginning of 2017 and nominal production of biogas could indeed be increased; however before the full potential of the current system could be evaluated, the operation with wood pellets had to be discontinued due to a fire in the pellets storage silo at the beginning of March 2017.

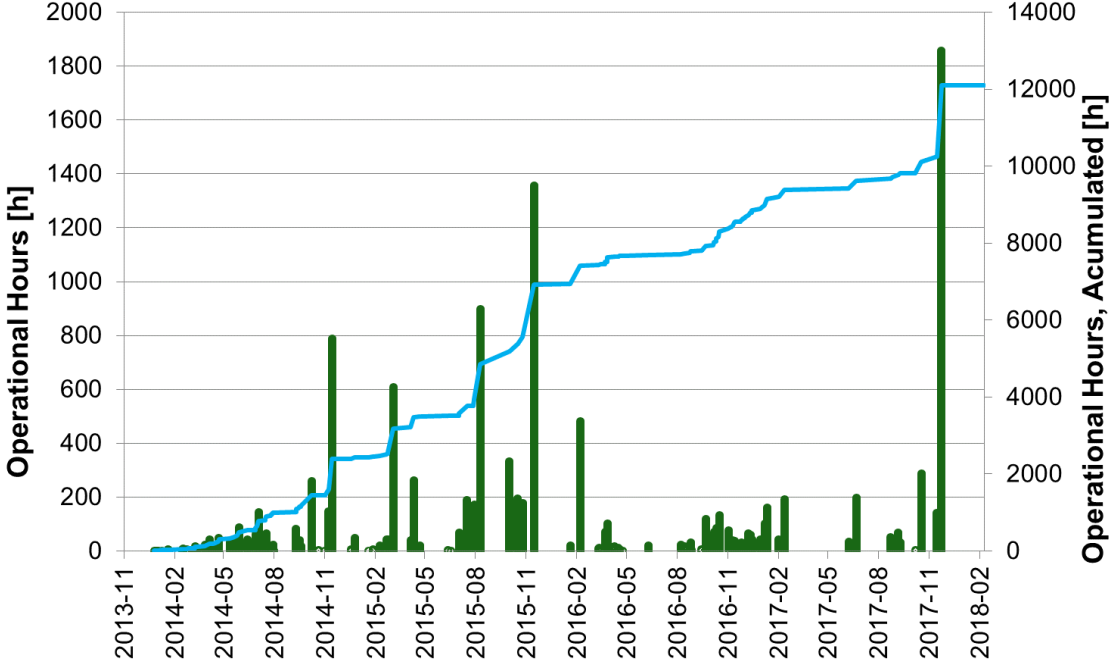

Figure 3.1: Operational history for the gasification section of GoBiGas, each bar represents a continuous run and the line is the accumulated number of operational hours.

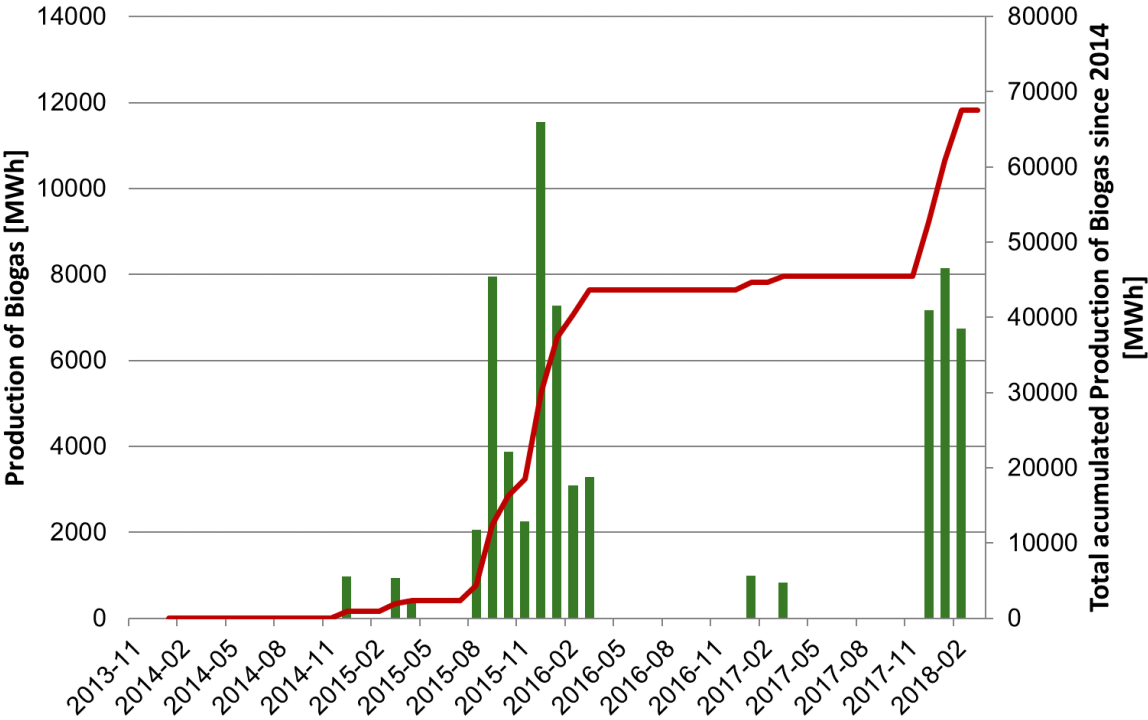

Figure 3.2: Biogas production, each bar represents a continuous run and the line is the accumulated production.

Without the ability to operate the GoBiGas plant with wood pellets, Göteborg Energi decided to make further attempts with chipped fuels, making some adjustments to cope with a somewhat higher amount of moisture in the fuel and with the goal of being able to operate with dried bark. In addition, further care was taken regarding fuel logistics to avoid exposing dried bark excessively to rain. The operation was reassumed after inspection of the plant in June 2017 with bark as fuel and this time without moisture content being a limiting factor. Instead, problems in the operation were caused by the formation of arches of fuel in the fuel feeding system. This made the feeding rate erratic and limited to a much lower rate than designed, such that the amount of gas produced was too low to operate methanation.

Instead of making further investments into the GoBiGas plant to redesign the fuel feed, it was decided to conduct further tests with chipped fuels with the goal of producing biomethane. As the moisture contents of the fuel is a key parameter in the process, alternative woody biomass with a low moisture content was considered. It was determined that recovered wood of class A1 (no paint or other treatments) could be a suitable fuel with a moisture content of 16–20%. The transition from bark to recovered wood went smoothly from a gasification point of view, with similar gas quality and gasifier performance. During the test period with recovered wood there was no problem in the feeding system related to nails, and satisfactory operation of the gasification section of the plant was achieved. Although a suitable fuel, the availability of recovered wood is limited and after about 100 hours of operation the fuel was shifted seamlessly to a mixture of sawmill residues and naturally dried stem wood. About 25–30% moisture could be coped with, still allowing methanation. However the moisture content varied too much and even went above 30% occasionally.

In December 2017, the pellets silo was repaired and the fuel was shifted back to wood pellets. Stable operation and production were established and from the middle of December 2017 to the end of February 2018 the gasifier operated continuously for 1,850 hours. The process was unfortunately stopped due to material fatigue in a chain in the fuel feeding system, but there were no real signs that process steps that had previously limited availability such as the product gas cooler and the fuel feeding screw would cause any further availability problems. Methanation operated continuously during the whole period apart from two days in December when the CO<sub>2</sub> compressor was maintained and for about one week in January when the process was briefly stopped. This was caused by unexpected features of the activated carbon, one of whose beds was replaced with fresh carbon during operation of the whole plant; see Appendix 1 for further details. This limited monthly production, illustrated in Fig. 3.2. However, nominal production was increased to record levels during this period, and for the first time the design goal of 20 MW of biomethane production was reached.

### 3.2 Major Lessons learnt

The commissioning of the GoBiGas demonstration plant brought several challenges. Through the hard work of the personnel on site and associated research activities, especially at Chalmers, vital experience on how to operate the process has been gained. The active collaboration with Metso was also vital regarding both operation and understanding the process, as were the open-minded discussions with the plant management at Senden (in 2018 owned by the Blue Energy Group GmbH) and the associated research groups; see for instance more details on the Senden plant M. Kuba *et al.* [5] from Bioenergy 2020+ GmbH.

The key personnel working at the GoBiGas plant are summarized in Appendix 3, while the key persons associated with research and development have been summarized by H. Thunman [3]. Appendix 2 provides a summary of research projects conducted in connection with the GoBiGas plant.

In this section, some of the most important conceptual lessons learnt are presented while more detailed system-by-system experiences are summarized in Appendix 1. The lessons learnt described here concern:

- How to **control gas quality** and tar level in the gas produced in the gasifier.
- How to limit and control **flue gas emissions**.
- Challenges related to the **product gas cooler and gasifier start-up**.
- How to limit the operational challenges related to the **fuel feed**.
- How to evaluate and operate the activated carbon **adsorption beds**.

### Controlling Gas Quality

Perhaps the greatest challenge and biggest achievements of the GoBiGas demonstration plant were related to the quality of the gas from the gasifier, especially tar. During fuel conversion in the gasifier, a large range of components discharges into gaseous phase, from permanent gases, such as H<sub>2</sub>, CO, CO<sub>2</sub>, CH<sub>4</sub>, C<sub>2</sub>H<sub>x</sub>, to condensable organic compounds, tar. The concentration of tar components in the gas must be limited to avoid clogging downstream components. Note that the need for limiting gas composition will be plant-specific and mainly depend on the process design and especially the product gas cooler. At GoBiGas the gas is cooled using hot water with a temperature of about 160°C, thus, measures for limiting tar level are required.

The composition and level of tar components depend on different process parameters including temperature and the activation of bed material, see e.g. [5-13] for more details. An active bed material means that bed material particles in some way affect chemical reactions in the gasifier and some material requires activation to attain the desired properties.

An active bed material commonly used in DFB gasifiers is olivine, which is a magnesium iron silicate based mineral. However, fresh olivine has a very limited effect on tar concentration and needs to be activated. During the commissioning of the GoBiGas gasifier, knowledge on how to activate the olivine was limited and the product gas cooler quickly clogged. Over time, this issue was resolved, and the aim of this section is to give a summary of the method applied to successfully limit and even control the level of tar in the gas at GoBiGas.

Previous experience from the plant in Güssing and research at e.g. TU Vienna and ECN had showed that components of the biomass ash played an important role in the activation of the olivine and Ca was identified as the key component. Results showed how a Ca-rich layer formed on the olivine particles that were activated, changing the properties of the bed material. However, even with a significant addition of Ca to the GoBiGas process, satisfying activation could not be achieved at GoBiGas. This indicated that another ash component could be significant for the activation of olivine. One component reported in literature to be an effective active component during coal gasification is K; see for instance [14]. Based on this, researchers at Chalmers investigated and concluded that potassium could be used to activate olivine [6]. After successful tests at the Chalmers gasifier, the method was applied at GoBiGas, significantly reducing the level of tar in the gas.

Figure 3.3 illustrates the flow paths of ash components and locations for the introduction of additives. The blue arrows indicate the looping of bed material between the gasifier and the combustor and it was shown that potassium components are transported between the reactors with the olivine material [6]. This enables the addition of potassium to the combustion side to achieve the potassium activation. A convenient and safe procedure is to pump K<sub>2</sub>CO<sub>3</sub> dissolved in water (40%<sub>mass</sub>) into the combustion reactor.

Some particles and ash components leave the gasifier with the raw gas and these are captured in a particle filter and reentered into the combustion side of the process, illustrated by green arrows in Fig. 3.3. In this manner, important ash components as well as the limestone added to the particle filter to protect the textile filters can be further utilized in the process. This flow also contains about 10–30% carbon from soot, char and tar, and the energy in these components is recovered through combustion. In a similar way, particles and ash components that leave the combustion reactor as shown by the umber arrows, are collected by reversing the flow in two steps and a particle filter. At the start of the project, some of the coarser ash from the flue gas was recirculated to the gasifier to recover as much ash as possible. However, it was discovered that this recirculation has a very negative impact on the fuel feeding screw as well as the product gas cooler, as discussed below. The recirculation of coarse ash was discontinued with improved operability as a result. For future plants, recirculating the coarse ash from the flue gas to the combustion side of the process is recommended if it is to re-enter the process. Further, if cooler design restricts the feasible tar concentration in the gas such that potassium activation is required and an ash-poor fuel such as wood pellets is used, it is crucial to add K, especially during start-up. By using more ash-rich fuel such as forest residues, the potassium content of the fuel might be sufficient to achieve K activation without additives, but in such cases it can still be convenient to control gas quality by using potassium as an additive.

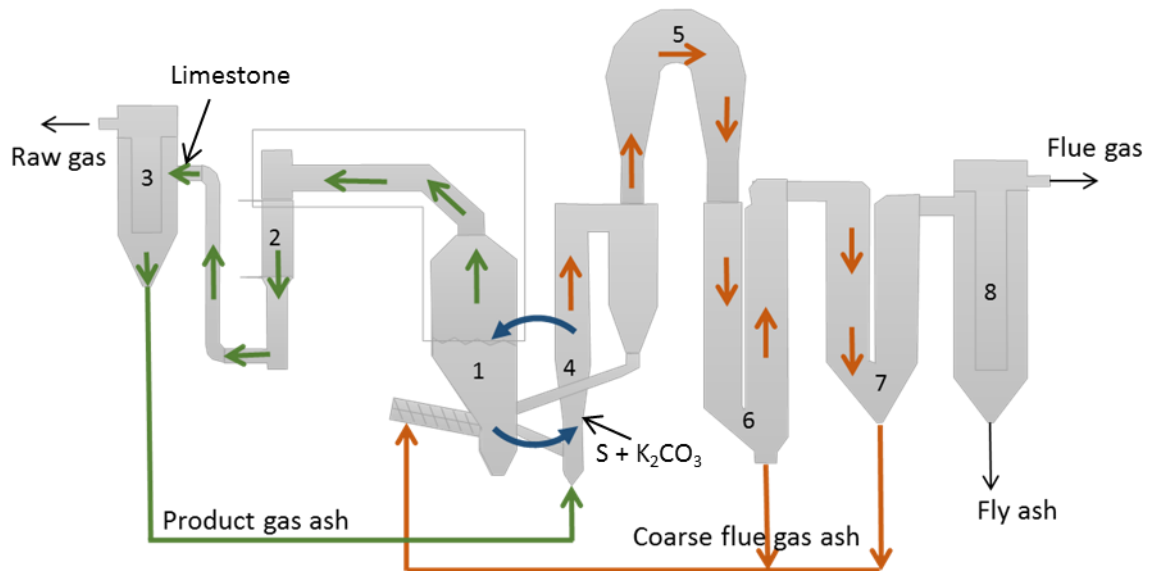

- |                       |  |
|-----------------------|--|
| 1. Gasifier           | 5. Post-combustion chamber                 |
| 2. Product gas cooler | 6. Convection path and flow reversal space |
| 3. Product gas filter | 7. Convection path and flow reversal space |
| 4. Combustion chamber | 8. Flue gas filter                         |

Figure 3.3. Illustration of the flows in the gasification section of the GoBiGas plant of the bed material (blue), product gas ash (green), and coarse flue gas ash (umber). Adapted from Thunman et al [15].

The loss of potassium with the flue gas is affected by the temperature in the process as it depends on the partial pressure of potassium-based components in the gas phase and it was concluded that it is beneficial to use a lower temperature, around 830°C in the gasifier bed to simplify potassium activation. Another important aspect regarding potassium activation is the amount of silicates added to the process with the fuel, as this can lead to the formation of K-Si components making the potassium inactive and sticky. With a high amount of silicates fed to the process with ash-rich fuels like bark or forest residues, bed refreshment is necessary by extracting bottom ash and compensating with fresh olivine.

During steady-state operation of the GoBiGas gasifier, changes in K balance proved to be rather slow, and after a stepwise change in the flow of  $K_2CO_3$  solution, it typically takes a few hours to reach a new steady state. The dynamics of the process indicate that bed material buffers potassium in the system, making the process stable. Of course, sudden changes in some process flows, especially the product gas ash that typically contains about 5% K, can have a very strong and much faster impact on the process. Hence, ensuring stable flows in process streams containing ash components is very important when implementing the potassium activation method. The concentration of tar at different levels of activation is illustrated in Fig. 3.4.

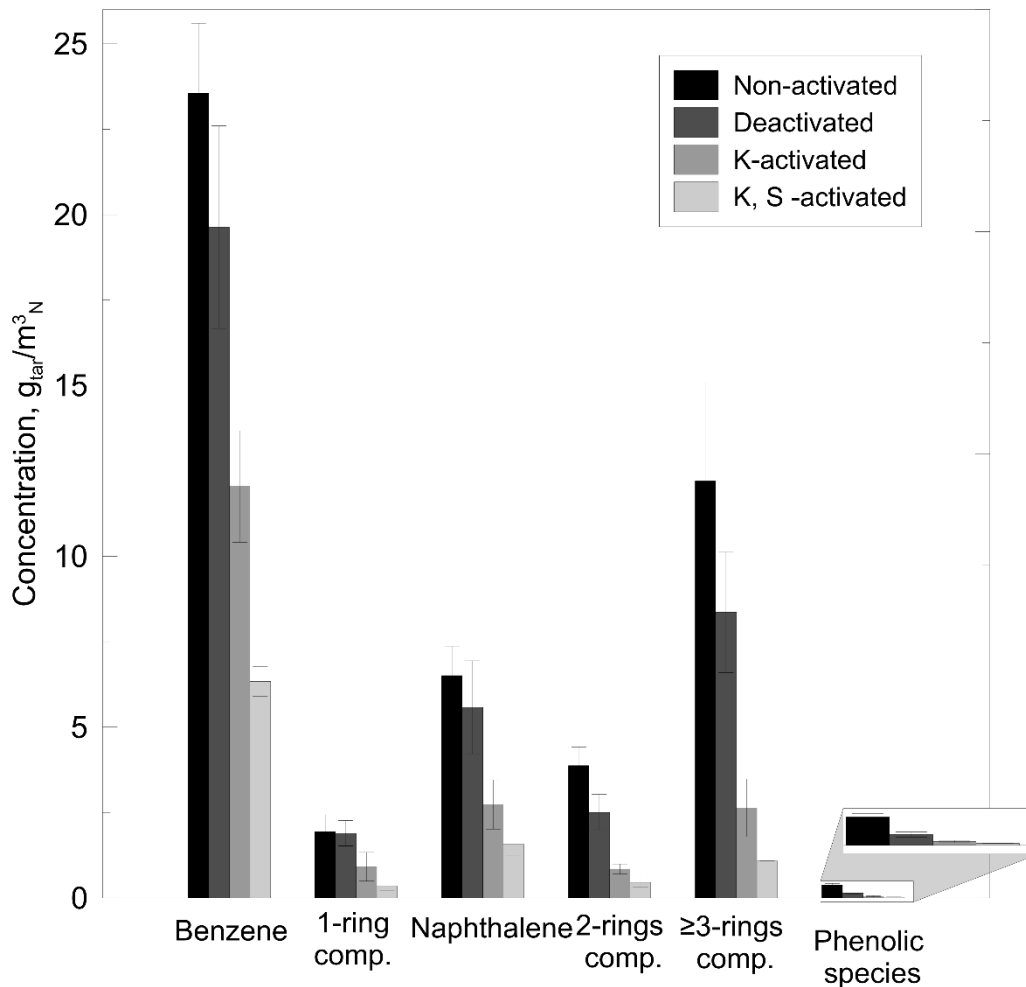

Figure 3.4: Tar concentration at different levels of activation. From [16].

Apart from the amount of potassium present in the system, the activation level is also affected by the type of potassium-based component formed in the combustion section and transported to the gasifier as shown by Marinkovic *et al* [6]. The addition of S proved especially effective and therefore a system for feeding elemental S to the combustion section of GoBiGas was implemented as part of the BioProGReSs project [17]. However, the effect of S addition quickly dissipates and is closer to a once-through based process than the equilibrium-based potassium-activation. The effect of S disappears in a matter of minutes when the feed is stopped and at GoBiGas it was mainly used as an extra measure during start-up before stable flows and thereby better control of gas quality was achieved.

To know how much potassium to add to the process, a control parameter must be defined. The goal is to limit the concentration of tar in the gas, but at this point there is no feasible technique for continuous online measurement. Instead, a method was developed based on an empirical correlation between the concentration of tar and the concentration of CH<sub>4</sub> in the gas, see [18-20] for more details. Figure 3.5 shows the established correlation for three different fuels and a rough indication that there is a process-specific limit for gasifier operation at GoBiGas, meaning that there is a window of operation for the process to run without problems. The limitations are related to the design of downstream equipment and are further discussed in the section that focuses on the product gas cooler.

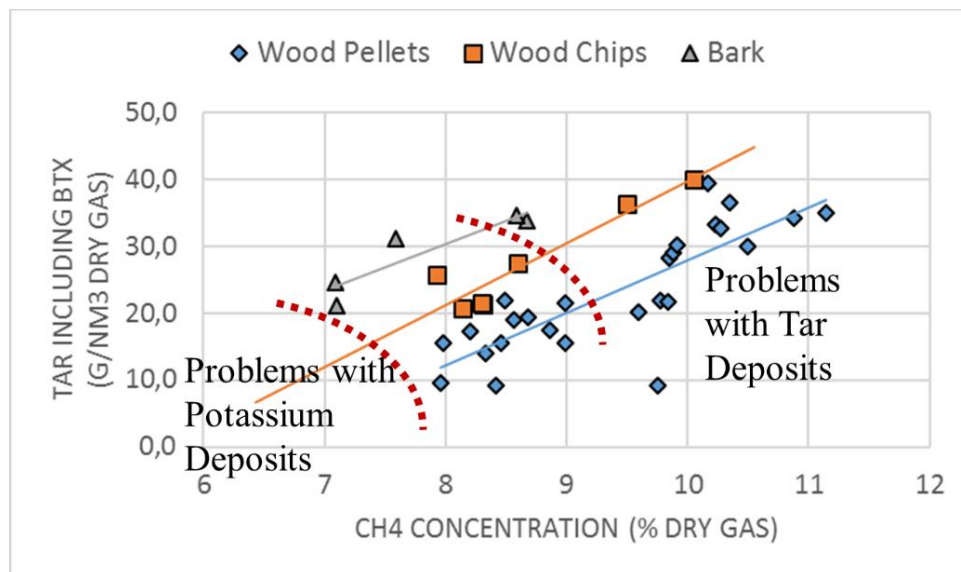

Figure 3.5: Concentration of tar in dry part of the Raw Gas as a function of CH<sub>4</sub> concentration, from [19].

With a correlation established between tar concentration and CH<sub>4</sub> concentration, a fully automated regulation of gas quality was established at GoBiGas where the flow of K<sub>2</sub>CO<sub>3</sub> solution feed to the combustor was regulated based on a set point for the concentration of CH<sub>4</sub> in the cold gas measured online. Suitable ranges for the CH<sub>4</sub> concentration when operating GoBiGas with different fuels are summarized in table 3.1.

Table 3.1: Summary of the recommended CH<sub>4</sub> concentrations for different fuels, from [19].

Fuel type	Recommended CH <sub>4</sub> Concentration
Wood Pellets	8.3–8.8% <sub>Vol</sub>
Wood Chips	8.1–8.7% <sub>Vol</sub>
Shredded Bark	8.0–8.6% <sub>Vol</sub>

### Flue Gases Emissions

Emissions from the combustion process flue gas are important aspects of the operation of a plant and the environmental permits for GoBiGas are further described below. In this section, some experiences related to the CO, NO<sub>x</sub> and NH<sub>3</sub> emissions are summarized while other limits gave rise to few or no challenges.

K-activation of the bed material not only has a strong impact on gasification but also affects the combustion process, where high potassium levels decrease burnout of CO in particular [15, 21]. However, the GoBiGas process is equipped with a post-combustion chamber (PCC) where unburnt

components form the primary combustion and off-gases from different parts of the methanation can be completely combusted. However, during commissioning of methanation, it became clear that with all the off-gases added to the PCC, it was not enough just to prolong residence time and inject additional air to avoid emissions of CO. Therefore, a gas burner was installed to control the temperature in the PCC by recirculating some of the produced cold gas. This enabled limitation of the CO emissions but also came with a rather large penalty in biomass to biomethane efficiency (in the order of 5 percentage points) of the process.

The challenges with CO emissions at GoBiGas arise when the intermittent flow of off-gases from the regeneration of the tar adsorption beds is fed back to the PCC and becomes even more challenging when the high-volume flow of CO<sub>2</sub> from the gas scrubbing is fed there as well. The CO<sub>2</sub> from the scrubber proved to be very pure (>99.9%<sub>vol</sub> CO<sub>2</sub> on dry basis with less than 600 ppm CH<sub>4</sub> and 10 ppm CO) and could be cleaned and utilized or vented directly to atmosphere, reducing the amount of cold gas required to be burnt in the PCC. The flow from the regeneration of the tar adsorption beds was most problematic as it is intermittent and can shift from pure steam to being very rich in combustible components, as described further below. The large variation in this flow not only presented challenges regarding emissions and thereby the gas burnt in the PCC, but also caused variations in the gasification and methanation processes, as the required amount of gas production varies. Studies were performed, confirming a reduction in the production cost to condense off-gases from the tar absorbers, and to reroute the CO<sub>2</sub> flow from the PCC to be technically feasible. However, this required further investments and was not implemented at the demonstration plant.

In summary, to improve the method of limiting CO emissions and to avoid the penalty in efficiency, the amount of off-gases with low heating value should be minimized and above all intermittency in the process should be avoided.

### Product Gas Cooler

The product gas cooler cools the hot raw gas from 700–800°C down to 160–240°C; it is located close to the exit of the gasifier as illustrated in Fig. 3.3. It is designed as a tubular heat exchanger where the gas moves downwards through vertical tubes cooled by pressurized hot water at about 160°C. A lot of operational challenges are coupled to the product gas cooler, and it was determined that the design chosen for cooling the gas defines the limits of the required gas quality from the gasifier at GoBiGas. The operational challenges can be summarized by three phenomena:

- Tar deposits. To avoid tar-related deposits in the cooler, it is important achieve a tar dew point that is lower than the temperature of the cooling media. However, without proper activation of the olivine bed material, tar dew point is well above 160°C, which is the temperature of the cooling media in the GoBiGas design. Thus, without the ability to limit the level of tar in the gas, the current cooler design led to extensive fouling and loss of heat transfer capacity. This manifests as increasing temperature of the gas exiting the cooler, and at GoBiGas the process has to be shut down when the temperature reaches 240°C as this is the maximum temperature of the downstream particle filter. This type of deposit is difficult to clean. First the whole process must be cooled down, then the cooler must be opened and the tubes cleaned one by one with water at 2,000 bar. This was done by an external contractor. As described above, this type of deposit can be avoided by activation of the bed material, reducing the concentration of the problematic tar components, Fig. 3.4.

- Particle deposits. The Raw Gas contains a lot of particles including fines from the bed material, ash particles, char and soot. With a low fuel load in the gasifier, gas velocity through the cooler tubes falls too low, enabling particles to stick to the tube walls which manifests as a greater pressure-drop and an increase in gas temperature at the outlet. This type of deposit can be done by avoiding long term operation of the gasifier at low fuel load. This type of deposit has also proven to be reversible and can diminish at higher velocities. An effective measure for diminishing this type of deposit was to add small bed material particles that become entrained and follow the gas through the cooler.
- Ash deposits. The tubular cooler design enables a compact cooler that quickly cools the gas. However, as the gas contains significant amounts of alkali ash components, the steep temperature gradient can lead to an extensive buildup of ash deposits. In the GoBiGas process, this was mainly manifested as an exponential increase of the pressure drop over the cooler as ash deposits build up mainly in the gas inlet of the cooler. Figure 3.6 shows a picture and composition of a rather extreme case of deposits from the top of the cooler. The sample is taken from the very top of the cooler and shows where the tubes were located. Note that deposits also built up in the top of the tubes, in some cases completely clogging them. Analysis shows there to be a high concentration of potassium in the deposits. Thus, when using the potassium activation method, care must be taken not to add too much potassium when using rapid cooling of the raw gas. Figure 3.7 shows the alkali concentration in the product gas during start-up and steady operation until too much potassium was added, causing deposits in the cooler. The results show that high concentrations of alkali components as well as particles are present in the gas. This should be considered when designing a cooler downstream of a biomass gasifier, especially if the potassium activation method is to be used. This type of deposit was mainly restricted to the gas entrance of the cooler, and could be mechanically removed by site personnel. However, the whole process still had to be cooled and vented before opening the cooler as there are no valves towards the gasifier. This type of deposit can be avoided by limiting the amount of potassium in the gasifier for instance based on the correlation in Fig. 3.5.

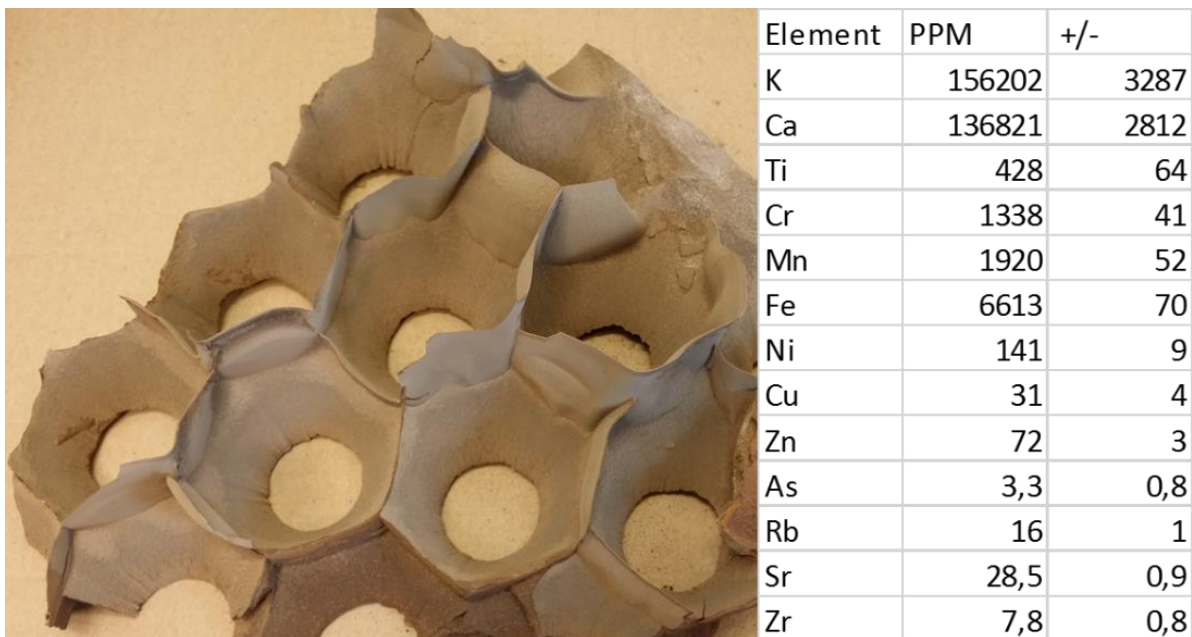

Figure 3.6: Picture of ash deposits extracted from the top of the product gas cooler and the results of the XRF analysis of the deposits, from [19].

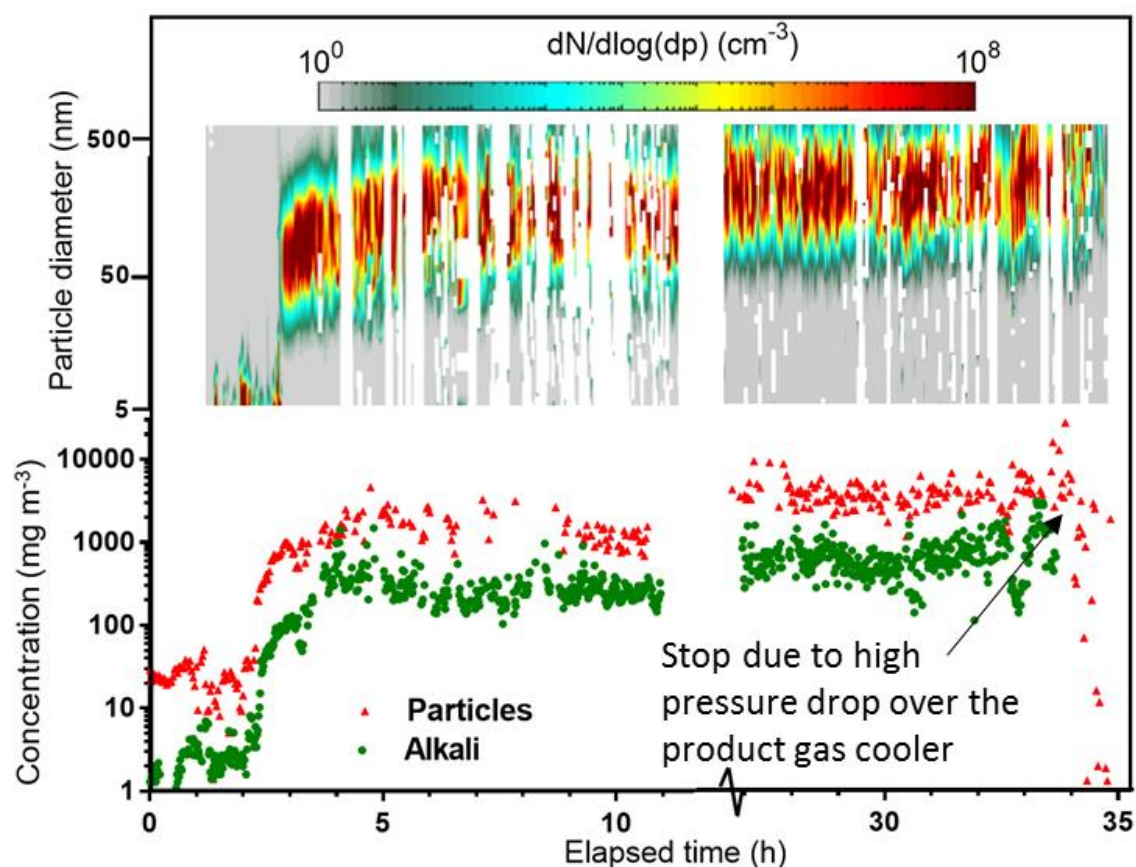

Figure 3.7: Concentration of different particle sizes (upper) and concentration of alkali (lower) in the raw gas from GoBiGas from start of the fuel feed (time 0 h), adapted from Gall et al. [22].

### Fuel Feeding Screw

The fuel is fed to the GoBiGas gasifier through a slightly inclined feeding screw that pushes the fuel into the bubbling bed in the gasifier. The fuel is fed to the side of the reactor which has an inclined wall without any fluidization which means that fluidization in this region is erratic or even stagnant. Figure 3.8 shows a down-scaled cold flow model of the fuel feeding screw showing how bed material tends to push into the screw. As the bed material is over  $800^\circ\text{C}$ , it carries a lot of heat and causes the fuel to start pyrolyzing already in the screw, forming deposits. These deposits cause a multitude of stops to the process as the torque required to operate the screw eventually becomes too high. The deposits at the front of the screw, closest to the gasifier, become very hard and consist of more or less pure carbon, while deposits further back resemble more the earlier stages of biomass pyrolysis. A wide range of measures were taken to reduce the build-up of deposits on the feeding screw including changes in the operational strategy of the gasifier, different screw designs, increased rotational speed, stronger motor and an increased purge gas flow. However, the effect of the changes could not be properly quantified as the final stop was caused by sudden spikes in the required torque rather than a slow increase that could be monitored. However, there were three measures that had a significant impact on the operation of the fuel feeding screw:

- Retraction of the screw from the bed.
- Decreasing the bed height in the gasifier.
- Discontinuing ash recirculation, which was fed to the gasifier together with the fuel.



Figure 3.8. Left: Cold flow model showing bed material pushed into the fuel feeding screw. Source: Claes Breitholtz, Valmet AB. Right: Feeding screw used in the GoBiGas plant, exhibiting mainly graphite-like deposits. From [15].

In a collaboration with Valmet and Chalmers, a cold flow model was constructed to study the dynamics of the feeding process. Both fuel and bed material were scaled down to mimic the conditions in the hot process as much as possible. It was determined that even with a high fuel feeding rate and rotational speed of the screw, a significant amount of bed material still entered the screw. In an attempt to limit the transport of bed material and thereby heat into the screw, the screw itself was retracted slightly from the bed to form a plug of fuel in front of the screw. The cold flow test was promising and the heat transfer to the screw was indeed decreased during the test at GoBiGas, where the screw was retracted corresponding to half a screw diameter. However, an unwanted side effect occurred as the pressure in the gasifier became more unsteady. This was probably due to a more uneven fuel feeding rate caused by the plug of fuel formed in front of the screw. Thus this was not an appropriate solution to the problems at GoBiGas and the screw was put back to its original position.

Another measure tested was to lower bed height in the gasifier to decrease the pressure in the screw. The purpose of pushing the fuel into the bed is to increase contact between the bed material and produced gases. However, with potassium activation of the bed material it was confirmed that bed height could be changed without any significant effect on gas quality, here represented by the concentration of  $\text{CH}_4$ , Fig. 3.9. Based on these results, bed height was lowered so that fuel was fed more or less straight to the surface of the bubbling bed and this effectively decreased the problems related to the fuel feeding screw, without reducing gas quality. Preparations were made to reconstruct the fuel feed to completely avoid contact between the fuel feeding screw and the bed material, feeding the fuel above the bed similar to the fuel feed of the Chalmers gasifier [23]. Also, improved fluidization was planned by avoiding inclined walls below the bed surface by using a properly fluidized flat bottom instead. The effect of improved fluidization has successfully been demonstrated at the plant in Senden where lower concentrations of tar were achieved as fluidization and thus mixing were improved [8].

The third and most effective measure was to simply avoid recirculating the coarse ash from the flue gas train to the gasifier via the fuel feed. It is not known if the potassium-rich ash just helped build-up the deposits by simply sticking to the pyrolyzed fuel or if it also affected the reaction, but it was clear that the ash significantly increased the build-up of deposits.

Feeding back a potassium-rich flow like coarse ash generally aids in the potassium activation of the bed material but the amount, particle size and composition of the ash varied a lot, which made it difficult to control the effect of the flow. Analyzed samples showed a potassium content of 2–7% in coarse ash compared to about 1–2% in bed material. Thus there was a risk of getting too much potassium when feeding ash back, causing clogging of the product gas cooler as described above. It is much more reliable to regulate the activation level by pumping a solvent than

recirculating ash. However, if the coarse ash is recycled to process to reduce bed material consumption and ash-based waste, it is probably better to feed it to the combustion side.

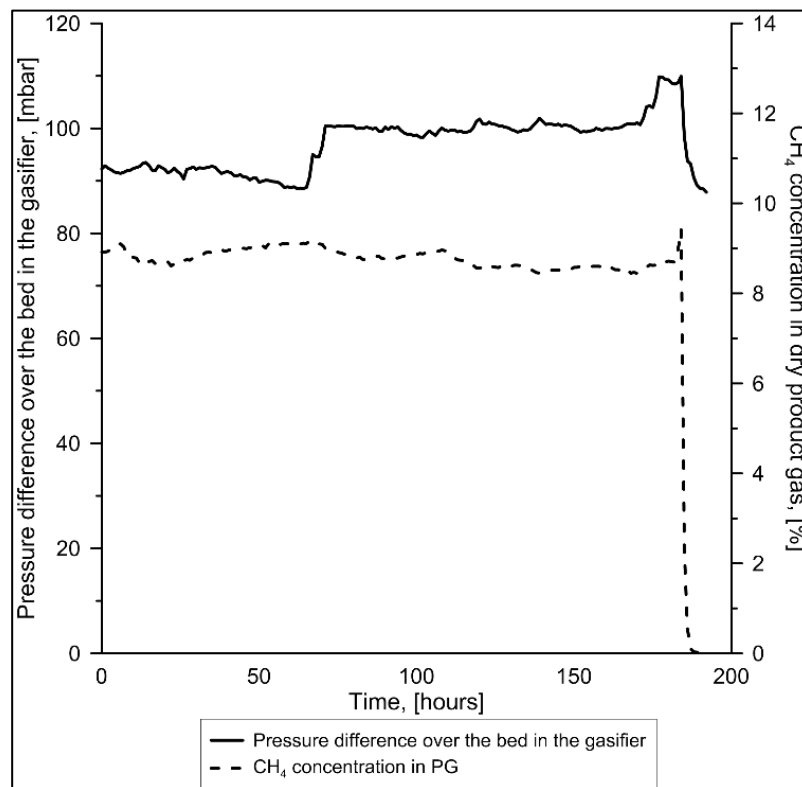

Figure 3.9: Methane concentrations and pressure drops over the gasifier fluidized bed during 200 h of operation as bed height was increased in two steps [15].

### Tar Adsorption Beds with Activated Carbon

Large tar components such as 3-ring aromatic hydrocarbons and larger are removed from the gas using a rape methyl ester (RME) scrubber, while lighter tar components, mainly benzene, are removed using adsorption. Naphthalene is partially removed in the RME scrubber, but a significant amount is still removed through adsorption. Adsorption is performed in fixed beds of activated carbon. There are four beds with activated carbon and three were initially operated in series as a pre-adsorber, bulk-adsorber and guard-adsorber while the fourth bed is regenerated and cooled and acts as an alternative bulk adsorber. The pre-adsorber was operated continuously with the main function of adsorbing trace large tar components such as 3 and 4-ring aromatics. The bulk adsorbers are operated in a sequence of three steps: 1) adsorption from the gas at about 50°C, 2) regeneration using superheated steam at about 245°C and 3) cooling with cold gas.

Two beds were therefore used as bulk adsorbers, while the pre-adsorber's only function is to adsorb very limited amounts of heavy tars, while the guard adsorber, as its name implies, only acts as an extra protection for the downstream catalyst in methanation. This operating method proved to limit plant capacity and cause other problems due to:

- Only 50% of the activated carbon acts to catch light tar (BTX and naphthalene).
- Regeneration for one bulk adsorber takes more time than available operating time.
- Once the guard adsorber receives a benzene spike, it tends to continue releasing small amounts of benzene for a long time.
- Since the tar content in the product gas from the gasifier varies depending on operating conditions and feed type, it was a challenge to avoid overloading the adsorption system.

In order to improve operation, the following measures were taken:

- A benzene analyzer (GC-FID) was installed downstream of the tar adsorbers providing continuous monitoring of adsorber operation. This improved operational knowledge and optimization capabilities tremendously.
- Re-programming the tar adsorber sequence to have three beds as bulk adsorbers and no guard adsorber.

Having three beds as bulk adsorbers added 50% more activated carbon in bulk service making regeneration and cooling much more efficient since one each of the three beds can be in adsorption, regeneration and cooling at the same time. Theoretical simulations together with field tests showed that the adsorption front of benzene in an adsorption vessel is rather sharp. This, together with the installation of an online benzene analyzer, made it possible to dispense with the guard adsorber. Operation with the modified tar adsorption system was successful and this system ceased being the plant bottleneck.

Figure 3.10 shows the concentration of Benzene and some light hydrocarbons in the gas downstream of the gasifier and the bulk adsorber change-over time is indicated by a dotted line. The trends show how the benzene concentration increases exponentially when it starts to leak from the bulk adsorber, and by monitoring the concentration the operation can be adjusted to avoid the benzene slip. Another interesting phenomenon seen is that when a newly regenerated carbon bed is cooled with product gas by operating in series with the bulk adsorber, the concentration of olefins drops significantly which affects downstream process equipment. Most notably, temperatures in several downstream reactors were affected as the concentrations changed rapidly, and the compressor was affected as the density of the gas changed, causing variation in both biomethane flow and quality. This effect can be minimized by passing a flow slowly through the adsorber before putting it into operation.

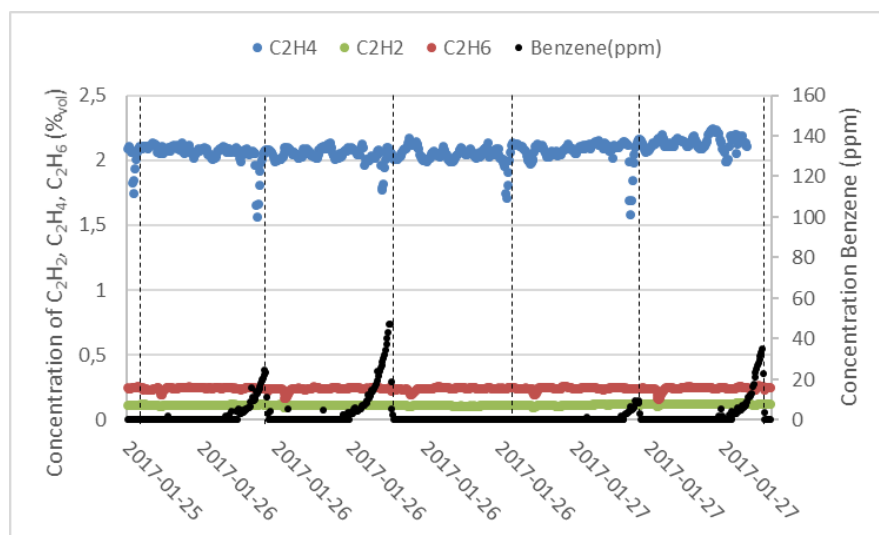

Figure 3.10: Hydrocarbon measured in the cold gas after the adsorption beds [19].

An important discovery is the presence of large polyaromatic hydrocarbons in the process downstream of the adsorption beds. It is still unknown how this is possible, and the concentration in the gas downstream is too low to analyze with the applied solid phase adsorption method used to measure tar. However, it was still enough to cause fouling on downstream equipment such as a compressor intercooler that gained a very yellow, grainy deposit as shown in Figure 3.11. This did not cause any real disturbances in the operation but with a higher plant availability, it might become an issue and must be considered in the design of future commercial plants.



*Figure 3.11: Deposits of tar components on the intercoolers in the product gas compressor.*

### 3.3 Evaluation of the Performance of the GoBiGas Process

The GoBiGas gasifier was operated in total for about 12,000 h and more than 67 GWh of biogas was delivered to the gas grid. The plant was operated using different fuels including:

- Wood pellets
- Wood chips
- Shredded bark
- Recovered wood, Class A1

The GoBiGas plant was commissioned using wood pellets but the aim was to operate with residues from the forestry industry. Different fuels were tested including wood chips produced from poor quality logs not utilized by the forestry industry, residues for sawmills, bark from a pulp plant and wood from recovered pallets (Class A1). The operating hours with each fuel and an overview of the process are summarized in Table 3.2.

Because wood pellets provided the most stable operation, the greatest number of operating hours is with this fuel. The challenges regarding the fuel feed and moisture content in the fuel were the major load-limiting factors during the demonstration. These fuel load challenges and restrictions complicate the comparison of the performance with different fuels. Further, production of biomethane was only possible with wood pellets and for other fuels the biomass to biomethane is here estimated based on the performance of the gasifier, described in more detail below. For the same reason, the greenhouse gas emission reduction factor was only evaluated for wood pellets.

Table 3.2: Overview of the operation of GoBiGas with different fuels.

Fuel	Pellets	Wood chips	Bark	Recovered Wood Class A1
Hours of operation (h)	~10,000	~1,150	~750	~100
Fuel moisture (%)	8–9	24–30	20–23	19–21
Load	80–100%	55–70%	40–70%	55–85%
Load-limiting factor	-	Moisture, fuel feed - mechanical	Fuel feed - mechanical	Fuel feed - mechanical
$\eta_{CH_4}$	50–63%	40–55%*	45–55%*	45–55%*
CO <sub>2,eq</sub> red.	80–85%**	-	-	-

\*Estimation base on gasification performance.

\*\*During steady-state operation.

The typical ranges for the gas quality produced in the gasifier with the different fuels are summarized in Table 3.3. The difference in gas quality is rather low as the gasifier is operated using potassium-activated olivine. Based on the gas quality, there would not be any problem to produce biomethane from any of the tested fuels if a steady and sufficient flow of gas can be produced. The N<sub>2</sub> concentration downstream of the gasifier was in the order of 0.2% when operating the whole plant, using CO<sub>2</sub> as a purge gas and wood pellets as fuel. Trends showing the gas composition and process performance over time are included in Appendix 5.

Table 3.3: Typical cold gas composition, tar level and operational parameters with different fuels.

	Wood Pellets	Wood Chips	Bark	Recovered Wood Class A1
Moisture content (% <sub>wt</sub> )	8–9	24–30	20–25	19–21
Gasifier temp. (°C)	870–830	790–830	850–820	820
H <sub>2</sub> (% <sub>vol</sub> dry)	40–42	39–41	39–43	38–39
CO (% <sub>vol</sub> dry)	24–25	20–23	17–21	21–23
CO <sub>2</sub> (% <sub>vol</sub> dry)	20–24	21–24	23–25	21–22
CH <sub>4</sub> (% <sub>vol</sub> dry)	8.3–8.5	7.9–8.6	7.1–8.7	7.1–8.1
C <sub>2</sub> H <sub>4</sub> (% <sub>vol</sub> dry)	2.3–2.5	2.3–2.6	~2.6	~2.6
Tar (excl. BTX), (g/m <sub>n</sub> <sup>3</sup> dry gas)	5.4–8.7	8.9–12.7	7.9–15.0	8.5–14
Tar (Incl. BTX), (g/m <sub>n</sub> <sup>3</sup> dry gas)	16.4–23.3	22.1–29.5	21.7–33.4	22–26

## Performance parameters

Process performance was been studied in detail by Göteborg Energi AB in collaboration with Valmet AB and Chalmers. An overview of the results is shown below. Performance parameters used to evaluate the process are summarized in table 3.4 and used in the flowing analysis of the plant.

Table 3.4: Summary and description of evaluation parameters used in the evaluation of GoBiGas

Notation	Unit	Description
$\eta_{RG}$	$\text{MJ}_{\text{raw gas}}/\text{MJ}_{\text{daf fuel}}$	Efficiency of the fuel conversion in the gasification reactor based on heating value in the raw gas and heating value of the dry ash free (daf) fuel.
$\eta_{CG}$	$\text{MJ}_{\text{cold gas}} / \text{MJ}_{\text{daf fuel}}$	Efficiency of the gasification process based on heating value of the tar-free cold gas and heating value of the daf fuel.
$\eta_{sect}$	$\text{MJ}_{\text{cold gas}} / \text{MJ}_{\text{daf fuel,El,RME}}$	Energy efficiency of the gasification section of the plant.
$\eta_{CH_4}$	$\text{MJ}_{\text{CH}_4} / \text{MJ}_{\text{daf fuel}}$	Efficiency of the conversion of biomass into biomethane.
$\eta_{plant}$	$\text{MJ}_{\text{CH}_4} / \text{MJ}_{\text{daf fuel,El,RME}}$	Efficiency of the plant. (Note that potential district heating production is not included.)
$X_{ch}$	$\text{Kg}_{\text{char conv.}}/\text{Kg}_{\text{char daf}}$	Degree of char conversion in the gasification reactor.
$\mu_C$	$\text{Kg}_{\text{C,CH}_4}/\text{Kg}_{\text{C,daf fuel}}$	Carbon utilization based on the fraction of C in the fuel attained in the produced biomethane.
$\eta_{Carbon}$	$\mu_C/\mu_C \text{ theoretical}$	Carbon conversion efficiency based on actual carbon utilization compared with the theoretically maximum of carbon in the fuel that can be converted into biomethane based on the composition.
$CO_{2,eq \text{ red.}}$	[-]	Fraction of greenhouse gas emission reduction as defined by the renewable energy directive [24].

To quantify these parameters, a number of measurements of both composition and flow are required. The measurements performed in the gasification section are described in Appendix 4 along with the equations for calculating performance parameters. The flow and composition of the produced biomethane and the electricity consumption of the plant were also measured. These efficiencies, char conversion and measurements performed are further described by A. Alamia *et al* [25].

## GoBiGas performance

The performance of the GoBiGas plant has been evaluated in detail [15, 25, 26] and some of the key results and conclusions are summarized here. The analysis of the process shows that a biomass to biomethane efficiency of over 70% can be achieved for this type of process.

Gasification was identified as the most important step in the process for the efficiency of the plant together with the amount of gas burnt in the PCC. The efficiency of the gasifier, in turn, is a function of the gasification process heat demand [23]. The heat demand of a DFB gasifier is related to the energy required to heat the incoming process streams such as combustion air and fluidization steam and the fuel and fuel moisture. Figure 3.12 shows how heat demand has a strong impact on the cold gas efficiency,  $\eta_{CG}$ , of the gasifier, and by increasing the pre-heating of the air and steam or reducing heat losses, a cold gas efficiency of around 80% is technically feasible and can enable  $\eta_{CG} = 70\%$  based on the lower heating value of dry, ash-free fuel.

High fuel moisture has a very negative impact on cold gas efficiency and should be minimized. The activation level has only a minor impact on the efficiency, but is more important for plant availability.

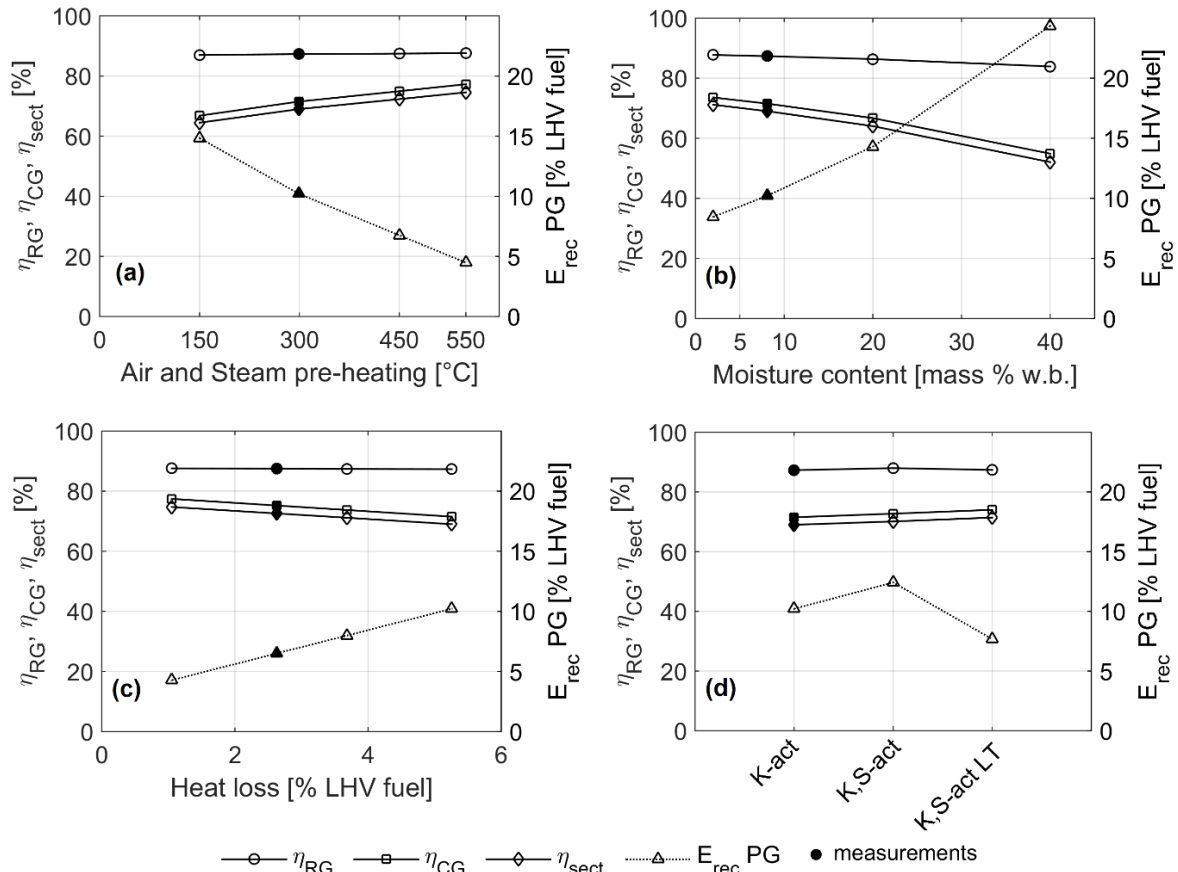

Figure 3.12: The efficiency of the gasification section as a function of different process parameters. Solid symbols represent data from GoBiGas and open symbols are extrapolations. From Alamia et al [25].

The energy balance of the GoBiGas gasifier was further studied by Alström et al. [27], who illustrated the energy flows as a Sankey diagram for operation with wood pellets and shredded bark, Fig. 3.13. The energy flows are normalized with the energy content of the fuel and presented as a percentage of the LHV of the daf fuel and show a case with  $\eta_{CG} = 72.1\%$  with pellets and  $\eta_{CG} = 54.5\%$  for bark. A significant difference is the moisture content of the fuel, which is about 8% for pellets and 25% for bark in the case investigated, and this affects the internal heat demand (iHD), which is the amount of heat that must be transported with the bed material from the combustor to the gasifier. With a higher iHD, the temperature difference or the circulation rate of bed material has to be increased and therefore a lower temperature in the gasifier was generally achieved when using moist fuels. The temperature in turn affects both the concentration and composition of tar in the product gas [20, 28].

Figure 3.13 also shows there to be a significant difference in the amount of energy transported from the gasifier together with the bed material to the combustor in the form of unconverted char. The char conversion was investigated in detail in a research project related to GoBiGas [29, 30]. In an optimized process, energy in the char transported to the combustor is equal to the total heat demand of the process. If it is lower, some of the product gas has to be recirculated to maintain process temperature, and if it is higher process temperature will increase. The amount of energy transported as char depends on the level of char conversion in the gasifier, as well as char yield during fuel pyrolysis.

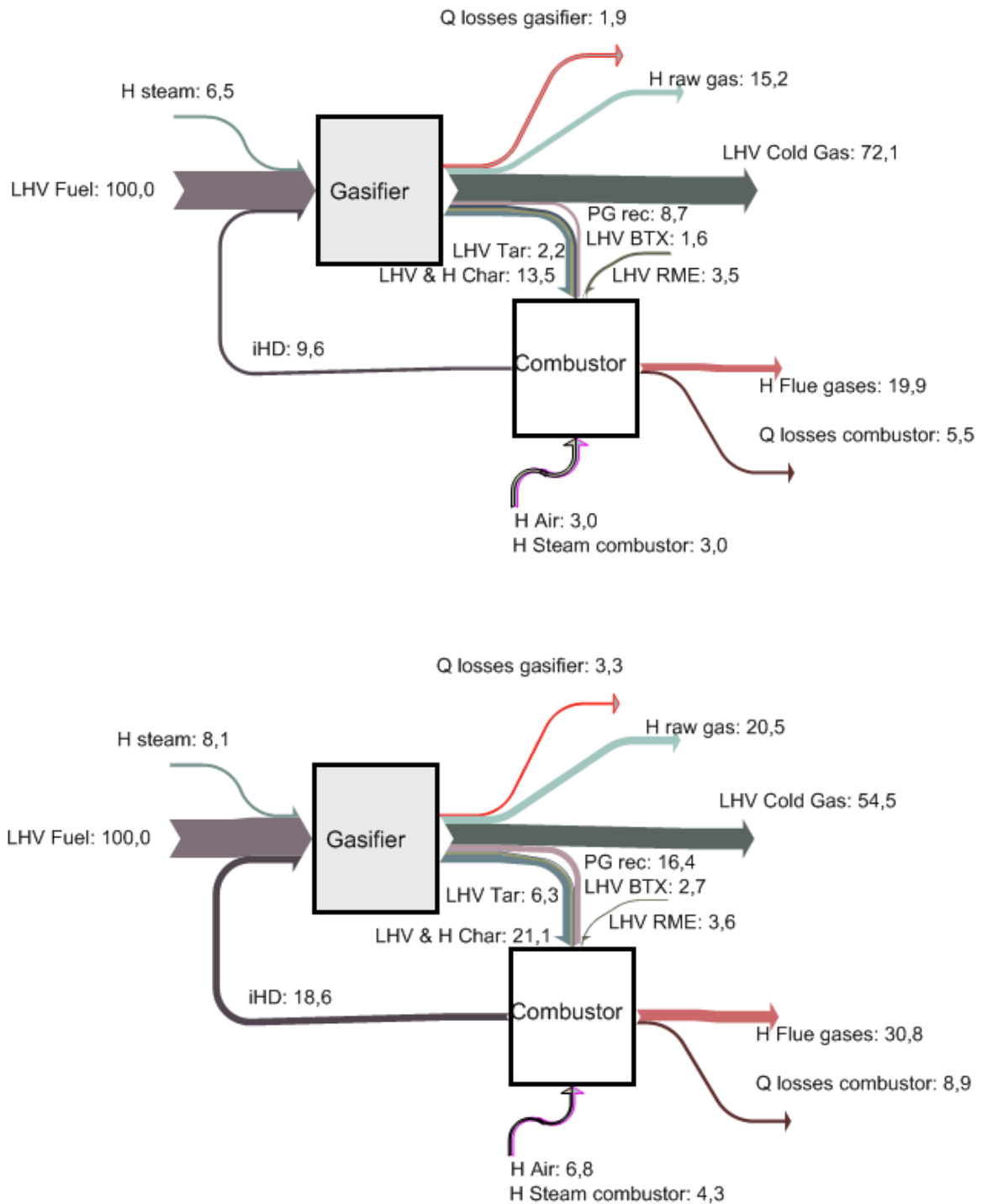

Figure 3.13: Sankey Diagram representing the energy balance of the gasifier section of GoBiGas when operating with wood pellets as fuel (above) and shredded bark with 25% moisture (below), normalized by the energy contents of the fuel based on the lower heating value, see J. M. Ahlström et al [27].

The proximate analysis of some relevant types of biomass is summarized in Table 3.4, which shows that the char yield from bark and forest residues can be significantly higher than for both wood pellets and wood chips. When gasifying these fuels in the pilot gasifier at Chalmers, it was clear that fuels with a similar char yield exerted a similar fuel conversion and thereby yielded a similar cold gas efficiency, as illustrated in Fig. 3.15. Thus performance when using forest residues can be expected to be similar to performance when using bark.

Table 3.4: Yields for volatiles, char and ash as %<sub>mass</sub> of dry fuel.

	Shredded bark	Bark pellets	Forest residuals	Wood pellets	Wood chips
Volatiles	70.08	69.63	73.99	80.57	80.21
Char	26.35	26.78	23.64	18.94	18.81
Ash	3.56	3.60	2.37	0.50	0.97

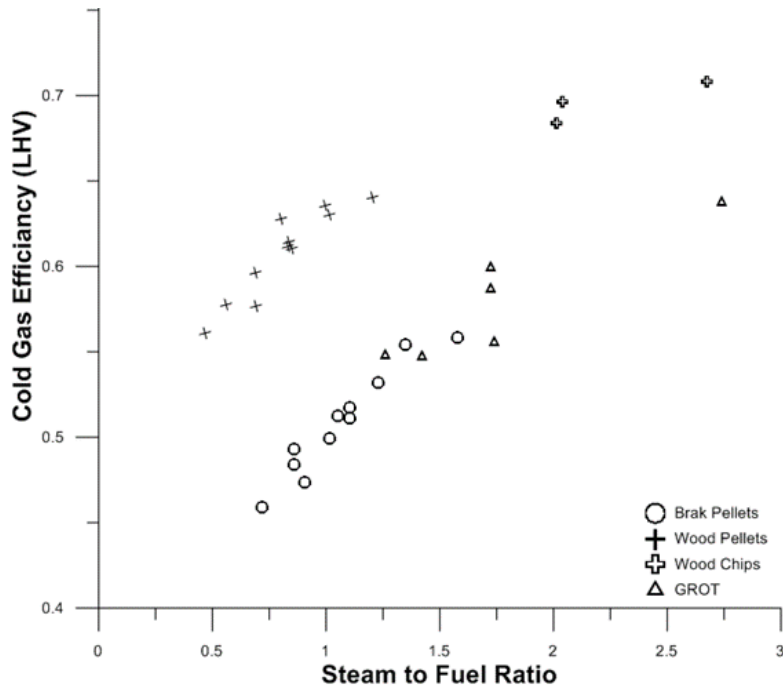

Figure 3.15: Cold gas efficiency of the Chalmers gasifier for different fuels as a function of the steam to fuel ratio.

The moisture content of fuel has a lower impact on gasifier performance compared to other fuel and process parameters. Figure 3.16 displays the cold gas efficiency of the GoBiGas gasifier as a function of fuel moisture content, illustrating a strong correlation. Thus, a commercial-scale stand-alone biorefinery based on biomass gasification must include a drier to reach good performance, and a very dry biomass with a moisture content as low as about 10% improves efficiency by more than 10 percentage points compared to a fuel with 30% moisture.

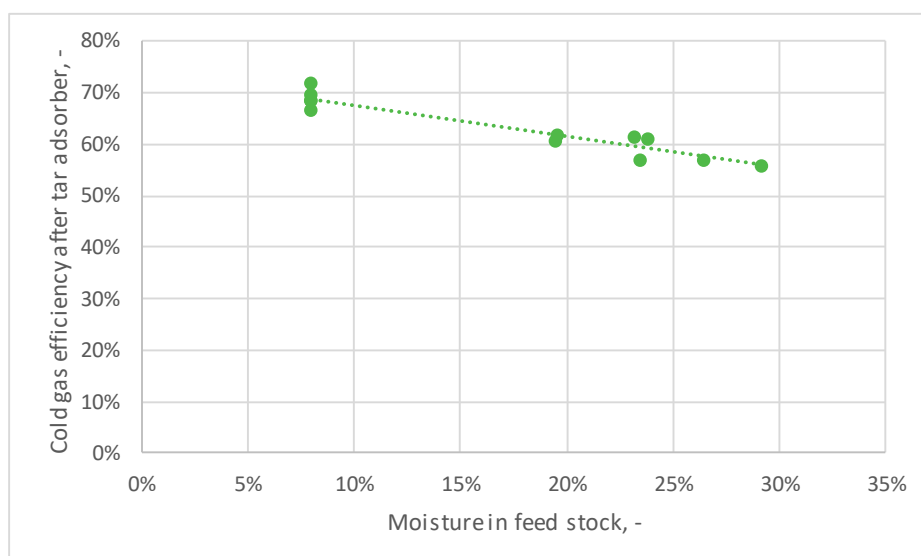

Figure 3.16: Cold gas efficiency of the GoBiGas gasifier as a function the moisture contents.

Gasification performance using very dry biomass with high char content such as dried bark or dried forest residues compared to very dry biomass with low char content such as wood pellets or dried wood chips, was estimated through extrapolation of the results using bark. The extrapolation is based on the mass and energy balance as described in detail elsewhere [27]. Results are illustrated in Fig. 3.17, where the reference bark case with 25% fuel moisture is denoted B25, the extrapolated bark case B8 and the comparing wood pellets case with 8% moisture is denoted P8.

Results show that with dry bark or forest residues, the GoBiGas plant could be operated with a cold gas efficiency of 65% and a biomass to biomethane efficiency of 56%. This is somewhat lower than for wood pellets due to lower raw gas efficiency. However, with improved char conversion in the gasifier, this could be improved and efficiency using char-rich fuels increased. Thus with an equivalent heat demand, a similar performance can be expected for any of the discussed biomass fuels, requiring a higher degree of char conversion when using bark or forest residues than with fuels based on stem wood. Thus with an optimized process with lower heat demand and higher char conversion, it is technically feasible to produce biomethane from bark or forest residues via gasification with an efficiency of up to 70% based on the lower heating value of the dry, ash-free fuel [15].

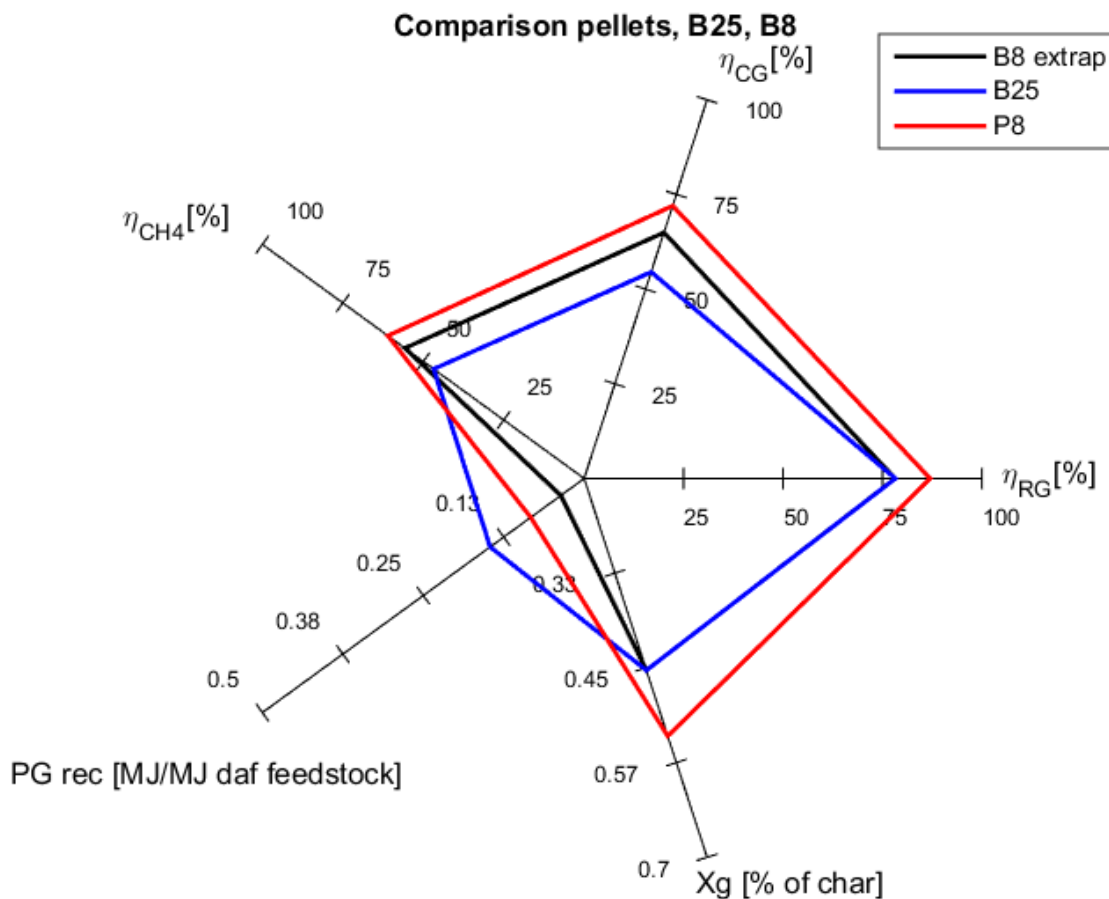

Figure 3.17: Comparison of important performance parameters while using wood pellets with 8% moisture (P8) and bark with 25% moisture (B25) and estimated performance with bark dried to 8% moisture (B8) based on extrapolation, see J. M. Alström et al [27].

### 3.4 Consumables, Waste Products and Emissions

Typical amounts of consumables required and waste products for disposal during steady state operation with wood pellets are summarized in table 3.5, excluding fuel consumption. Consumption was estimated using wood pellets as fuel while operating the whole plant producing 19–20 MW of biomethane.

*Table 3.5: Summary of typical amounts of consumables and waste products during steady state operation with wood pellets*

Consumable/Waste Product	Quantity	Unit	Comment
Natural Gas	64–100	m <sub>n</sub> <sup>3</sup> /h	Steam production in methanation
N <sub>2</sub>	1.7–4.0	m <sub>n</sub> <sup>3</sup> /h	Purge, more during start-up
Olivine	18–65	Kg/h	Norwegian olivine
RME	~ 70	Kg/h	
Limestone	80–120	Kg/h	
K <sub>2</sub> CO <sub>3</sub> , 40% solved in water	5–10	L <sub>n</sub> /h	
Bottom ash	100–150	Kg/h	Extracted from gasifier
Fly ash	20–35	Kg/h	From flue gas cleaning
Electricity	1.9–2.2	MW	Major part for compression
Fresh water	~4	m <sub>n</sub> <sup>3</sup> /h	
Process water	0.6–1.0	m <sub>n</sub> <sup>3</sup> /h	

Emissions from the gases was measured online with an FTIR and a dust detector. Typical values and limitations defined by regulation are summarized in Table 3.6.

*Table 3.6: Typical flue gas emissions and regulated limits*

Component	Typical measured values (mg/Nm <sup>3</sup> )	Regulated limit (mg/Nm <sup>3</sup> )	Defined basis for the regulated limit
NO <sub>x</sub>	48	95	Yearly average based on 6% O <sub>2</sub> in flue gas
Dust	< 1.4	10	
NH <sub>3</sub>	23	-	
N <sub>2</sub> O	1.8	-	Based on 11% O <sub>2</sub> in flue gas
CO	Large variation due to intermittent flows of off-gases to the PCC so that extensive combustion of product gas in the PCC was required not to exceed the limit.	500	24 h average based on 6% O <sub>2</sub> in flue gas

The methane slip from the GoBiGas plant was measured by a certified third-party laboratory (DGE Mark och Miljö AB) during full operation of the plant in February 2018. Results indicated that methane slip corresponded to less than 0.04% of total methane production. This can be compared to the regulated limit of 0.5%, which is more than ten times higher than the actual value. The results show that very low slip can be achieved in advanced biorefineries such as GoBiGas.

### 3.5 Greenhouse Gas Emission Reduction Factor and Carbon Efficiency

The greenhouse gas emission reduction factor, as defined by the European renewable energy directive (RED), is estimated for each batch of gas produced, including everything consumed from the start of heating the process to the end of production. The factor is based on the reduction of CO<sub>2,eq</sub> emissions, when burning the biomethane produced compared to the combustion of petrol or diesel based on a well-to-wheel analysis. The analysis includes the use of fossil fuels for transporting the biomass as well as the use of natural gas to heat the process, which are the two major sources of emissions at the GoBiGas plant. Figure 3.18 illustrates the greenhouse gas emission reduction factor as a function of operating time starting with heat-up of the gasification section. Due to the consumption of natural gas during process heating, and because it takes a couple of days to start the whole process, more than 100 hours pass before any reduction at all, and it takes about 400 hours to reach a reduction above 80%. The greenhouse gas emission reduction factor is used to determine whether a biofuel can be defined as an advanced biofuel and the limit is defined at the national level. The required reduction in Sweden during the GoBiGas project was 50% and was thus easily exceeded at GoBiGas. By exceeding this limit, the gas produced could be sold as renewable vehicle gas with a tax exemption.

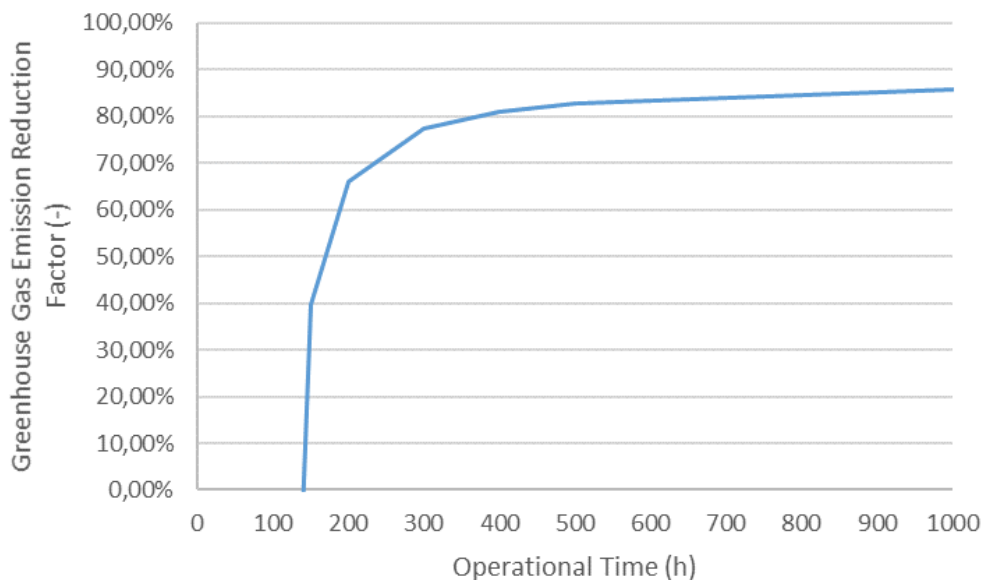

Figure 3.18: Greenhouse gas emission reduction factor as a function of operating time starting from gasification heat-up.

The carbon utilization factor for GoBiGas was typically around 0.3, which means that 30% of the carbon in the biomass is relocated to produced biomethane while the remaining 70% is released as CO<sub>2</sub>. Compared to the maximum theoretical carbon utilization of about 0.5, based on the composition of the biomass and methane, this corresponds to a carbon conversion efficiency of 0.55–0.60. This means that during operation, about 40% of the carbon that could theoretically be converted to methane is instead converted to CO<sub>2</sub> in the combustion reactor to heat the process. By decreasing process heat demand, both carbon utilization and efficiency can be improved. In summary, about 48% of the carbon in the fuel is converted to CO<sub>2</sub> in the produced gas due to the oxygen content of the biomass and separated as pure CO<sub>2</sub> with a scrubber, while about 22% is converted to CO<sub>2</sub> in the flue gas and around 30% is retained in the biomethane.

### 3.6 Quality of the Produced Biomethane

In 2015, a partnership was formed between Göteborg Energi and Engie for the purpose of supporting the development of biomethane production via gasification. Specifically, the goal was to investigate if the produced gas was in compliance with the EU standard for injection of biogas into the gas grid (16723-1) and the EU standard regarding utilization as vehicle gas (16723-2). At the end of 2017, a joint measurement campaign was conducted where Engie measured the quality of the gas produced at GoBiGas and delivered to the gas grid. The compounds measured and the sampling and measurement methods are summarized in Table 3.7.

Table 3.7. Summary of measured compounds, sampling methods and analysis techniques used to characterize the gas produced by GoBiGas.

Targeted compounds		Sampling Technique	Measurement Technique
Main Gases	CH <sub>4</sub> , N <sub>2</sub> , CO <sub>2</sub> , CO, H <sub>2</sub>	Canister	μGC-TCD
	Total Hydrocarbons	Canister	μGC-TCD
Sulfurs	H <sub>2</sub> S, COS, mercaptans	Traited Canister	GC-PFPD
	Thiophene	Sorbent Tube (Solid Phase Adsorption)	TDS-GC-MS
Tars	BTEX	Traited Canister	μGC-TCD
		Sorbent Tube (Solid Phase Adsorption)	TDS-GC-MS
	Naphtalene	Sorbent Tube (Solid Phase Adsorption)	TDS-GC-MS
	Phenol and derivatives	Sorbent Tube (Solid Phase Adsorption)	TDS-GC-MS
	Others Tars (PAHs, ...)	Sorbent Tube (Solid Phase Adsorption)	TDS-GC-MS
Others Trace Compounds (According to specifications of the gas grid)	Ammonia (NH <sub>3</sub> )	Traited Canister	OFCEAS (Proceas)
	Mercury (Hg)	Sorbent Tube (Solid Phase Adsorption)	Atomic Fluorescence Spectroscopy
		Impinger Technique	Ionic Chromatography
	Total Chloride (Cl)	Sorbent Tube (Solid Phase Adsorption)	TDS-GC-MS
		Impinger Technique	Ionic Chromatography
	Total Fluoride (F)	Sorbent Tube (Solid Phase Adsorption)	TDS-GC-MS
Sorbent Tube (Solid Phase Adsorption)		TDS-GC-MS	
Others Trace Compounds (Screening, not specified)	Trace organic compounds (N, O, S, C)	Sorbent Tube (Solid Phase Adsorption)	TDS-GC-MS

The main gas composition is summarized in Table 3.8, where one value of particular interest is the hydrogen concentration which is limited to 2% in the 16723-2 standard, and which is exceeded at times. This affects the possibility of using the gas directly as a vehicle fuel without mixing with natural gas on the grid.

Table 3.8: Main gas components.

Compound	Content		Content		
	Sampling ENGIE / GRTgaz		Measurements Göteborg Energi during the period of sampling		
	Sampling 1	Sampling 2	Min	max	average
O <sub>2</sub>	0,01 %mol	< 30 ppm-mol	No measurement		
N <sub>2</sub>	0,6 %mol	0,6 %mol	0,5 %mol	0,6 %mol	0,5 %mol
CH <sub>4</sub>	96,4 %mol	95,7 %mol	95,9 %mol	98,0 %mol	97,1 %mol
CO <sub>2</sub>	0,04 %mol	0,03 %mol	nd	0,6 %mol	0,1 %mol
CO	< 100 ppm-mol	< 100 ppm-mol	No measurement		
H <sub>2</sub>	3,0 %mol	3,6 %mol	1,2 %mol	3,5 %mol	2,3 %mol

No sulfur was measured in the gas except for tetrahydrothiophene, which was detected but below the level of quantification. The gas was also clean from polyaromatic hydrocarbons (PAH) of which no PAH exceeded a concentration of 0.1 µg/scm. Very low concentrations of BTEX component were measured as shown in Table 3.9., and the total BTEX concentration never exceeded 100 µg/scm. Also, trace component concentrations were very low as summarized in Table 4.10. THT is added to the gas to give it an odor to make it easy to detect in case of a leak.

Results show that the gas produced was clean and in compliance with the standard 16723-1, thus fulfilling the requirement for gas grid injection in the European market.

Table 3.9: BTEX components

Compound	Content or range of content (µg/scm)	
	Sampling 1	Sampling 2
Benzene	1,5	14,3
Toluene	nd	2,0
Ethylbenzene	0,05	0,2
(p+m)-Xylenes	0,08	1,9
o-Xylene	0,06	0,6
Styrène	< 0,1	0,1 - 5
3-éthyltoluène	< 0,1	0,1 - 5
4-éthyltoluène	< 0,1	0,1 - 5
1,3,5-trimethylbenzene	0,1 - 5	0,1 - 5
2-Ethyltoluène	< 0,1	0,1 - 5
1,2,4-Triméthylbenzène	0,1 - 5	< 0,1
1,2,3-Triméthylbenzène	< 0,1	0,1 - 5
1,2,4,5-Tetramethylbenzène	< 0,1	< 0,1
Benzene, 1-methyl-2-(1-methylethyl)-	0,5 - 5	< 1

Table 3.10: summary based on trace component screening.

Parameter	Compound	Unit	Content
Ammonia		mg/scm	< 0,4
Mercury (Hg)		µg/scm	0,007
Total Chloride	Inorganic chloride	mgCl/scm	< 1
	Organic chlorides		not detected, < 0,01
Total Fluoride	Inorganic fluoride	mgF/scm	< 1
	Organic fluorides		no measurement

## 4 Commercial Production of Advanced Biofuels via Gasification

The purpose of the GoBiGas demonstration plant was to evaluate the technical and economic feasibility of the technology for building a commercial scale unit with a production of 100 MW or larger.

### 4.1 Technical Performance

The best technically feasible performance for a commercial plant for production of biogas via gasification was estimated based on the evaluated performance of the GoBiGas demonstration plant by Alamia *et al* [25]. Figure 4.1 shows the results of a case study based on the use of dried and moist fuel as well as different operational cases. In summary, a biomass to biogas efficiency of about 70% is technically feasible based on the analysis of the demonstration plant.

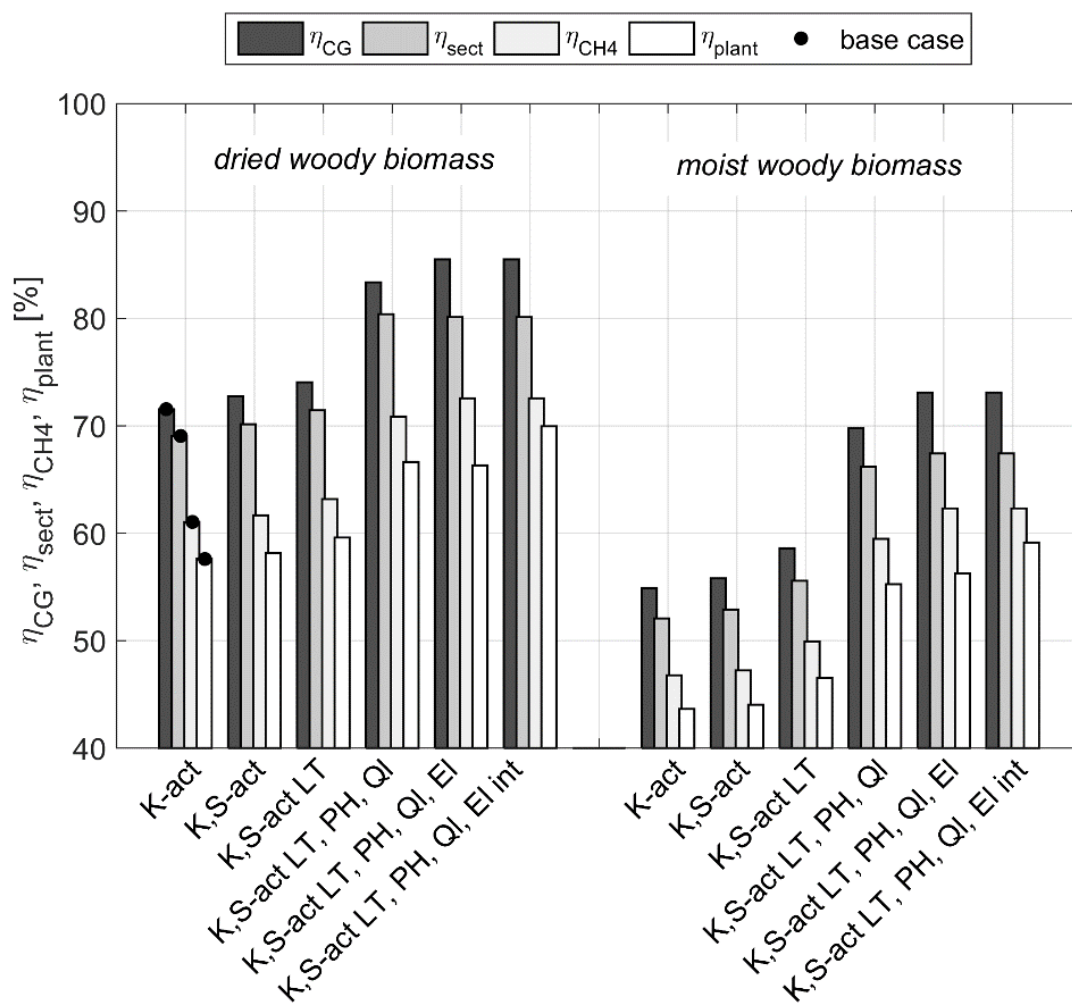

Figure 4.1: Case study of the feasible technical performance of a process based on the technology applied at GoBiGas, from Alamia *et al* [25]. Dried woody biomass has a moisture content of 8% and moist woody biomass a moisture content of 40%.

The GoBiGas process is an example of an advanced biofuel production (ABP) plant and a more generalized analysis, summarized in Table 4.1, shows that the following factors are of great importance for the performance of an ABP plant:

- Drying of the biomass.
- Integration with electrical production and/or electrolysis.
- Co-production or product gas utilization

While drying increases electricity consumption, it has a positive impact on plant performance and there are good arguments for including a drier in a commercial unit considering both performance and operational stability.

If electricity generation is included (steam cycle) and this electricity is used in the plant, either for heating the gasification process or by producing hydrogen through electrolysis and adding it to the process, biomass to biogas production ( $\eta_{\text{CH}_4}$ ) could be increased further. If only electricity generated at the plant (denoted  $\text{zero}_{\text{EI}}$ ) is utilized,  $\eta_{\text{CH}_4}$  increases by 0.8 percentage points (pp) with electrolysis, while direct heating can increase it by about 1.4 pp. If the maximum amount of electricity is added ( $\text{max}_{\text{EI}}$ ) by importing electricity into the plant, the potential increase in  $\eta_{\text{CH}_4}$  is 8.4 pp with electrolysis and 5.2 pp with direct heating. Note that the amount of electricity added as direct heating is limited by gasifier heat balance while the maximum amount of electricity added through electrolysis is related to the composition of the product gas. More electricity can generally be added through electrolysis.

The marginal efficiency for the conversion of power to gas in this manner ( $\eta_{\text{P2G}}$ ) is about 60–65% when using electrolysis, meaning that for 1 MW of electricity spent, gas production increases by 0.6 MW. When using electricity for direct heating, a marginal efficiency greater than 100% can be achieved, meaning that adding 1 MW of electricity increases production by more than 1 MW of gas. This is only possible for a limited amount of electricity and efficiency is only marginally above 100%. This occurs when process heat demand is reduced, e.g. pre-heating an ingoing stream, reducing the demand for combustion such that the flow of combustion air can be decreased, thereby further decreasing process heat demand and increasing fuel conversion efficiency.

Power to gas was successfully implemented at GoBiGas through direct heating and a marginal efficiency above 100% by additional heating of the steam used to fluidize the gasifier. About 500 kW of electrical energy was restored as biomethane in this manner. By monitoring biomethane, biomass feedstock and electricity prices, it would be possible to determine hourly whether it was economical to use electricity and if so, whether it was most economical to use it to increase production capacity, or instead decrease feedstock.

Depending on the purpose of a gasification-based plant, the product gas from the gasifier could be used without further upgrading, e.g. to replace steam-reformed natural gas in industry or a combustible gas. In such an application, a biomass to gas efficiency of more than 85% could be possible if the electricity generated is used in the process, and even above 90% if additional electricity is used.

The investigation further indicates the potential for the co-production of ethanol or hydrogen showing that a plant efficiency ( $\eta_{\text{tot}}$ ), based on LHV, of about 70% can be achieved for the co-production of both ethanol and hydrogen. See Alamia *et al* for more details [26].

Table 4.1: Results of the simulation of different plant designs, biomass input 100 MW<sub>daf</sub> and RME input 3.3 MW<sub>RME</sub>, adapted from[26] see ref. for detailed description of the simulations and design cases.

Production	CH <sub>4</sub>	CH <sub>4</sub>	CH <sub>4</sub>	CH <sub>4</sub>		CH <sub>4</sub>		CH <sub>4</sub> + Ethanol		Product Gas		CH <sub>4</sub> + H <sub>2</sub>	
Case	No drying	Air drying	Steam drying	Electrolysis		El - direct heating							
Sub Case				zero <sub>El</sub>	max <sub>El</sub>	zero <sub>El</sub>	max <sub>El</sub>	C80%	C50%	zero <sub>El</sub>	max <sub>STG</sub>	zero <sub>El</sub>	max <sub>H2</sub>
Material products													
Biomethane [MW <sub>CH4</sub> ]	57.6	67.9	72.0	72.8	80.4	73.4	77.2	42.5	49.1	0	0	51	35.6
Ethanol [t/h] <sup>a</sup>		0	0	0	0	0	0	3.41	2.69	0	0	0	0
STG [MW <sub>STG</sub> ] <sup>b</sup>		0	0	0	0	0	0	0	0	85.6	91.6	0	0
Hydrogen [MW <sub>H2</sub> ]		0	0	0	0	0	0	0	0	0	0	22.5	42.4
Separated CO <sub>2</sub> [t/h] <sup>c,d</sup>	15.4	16.3	16.4	16.3	15.4	16.5	17	10.1	10.8	7.1	7.1	20.0	23.3
Electricity balance													
El <sub>out</sub> , (-)El <sub>in</sub> [MW <sub>el</sub> ]	4.7	2.4	1.2	~ 0	- 12.8	~ 0	- 3.4	~ 0	~ 0	~ 0	- 3.8	~ 0	- 6.1
El <sub>demand</sub> [MW <sub>el</sub> ]	4.1	4.7	5.3	7.1	20.5	7.0	10.5	4.3	4.7	4.5	4.8	6.2	12.1
- Compressor [MW <sub>el</sub> ]	2.9	3.2	3.4	3.4	3.5	3.5	3.8	1.6	2.6	3.2	3.4	3.3	3.4
- Dryer [MW <sub>el</sub> ]		0.35	0.8	0.8	0.8	0.8	0.8	0.8	0.8	0.80	0.80	0.8	0.8
El <sub>P2G</sub> [MW <sub>el</sub> ]				1.2	15	1.2	4.8						
LT Heat demands													
Q <sub>reboilers</sub> [MW] <sup>e</sup>	5.6	6.0	6.1	6.0	5.6	6.0	6.3	5.1 <sup>4</sup>	5.2 <sup>4</sup>	2	2.1	7.3	10.0
Q <sub>dryers</sub> [MW]		6.1	8.9	8.9	8.9	8.9	8.9	8.9	8.9	8.9	8.9	8.9	8.9
Efficiencies													
η <sub>CG</sub> [% LHV <sub>daf</sub> ]	68.1	79.8	84.8	85.7	94.7	86.7	91.0	84.8	84.8	85.6	91.6	84.8	84.8
H <sub>CH4</sub> [% LHV <sub>daf</sub> ]	57.6	67.9	72	72.8	80.4	73.4	77.2	67.9	69.1	-	-	73.5	78
η <sub>tot</sub> [% LHV <sub>daf</sub> ]	62.3	70.3	73.2	72.8	70.5	73.4	73.8	69.7	71.1	85.6	88.2	73.5	73.6
H <sub>CH4</sub> [% LHV <sub>a.r.</sub> ] <sup>f</sup>	66.3	78	82.8	83.8	92.5	84.4	88.8	78.1	79.5	98.5	105.4	84.6	89.7
η <sub>tot</sub> [% LHV <sub>a.r.</sub> ] <sup>f</sup>	71.7	80.9	84.2	83.8	81.1	84.4	85.0	80.2	81.8	98.5	101.5	84.6	84.7
η <sub>P2G</sub> [%]				65 <sup>g</sup>	60 <sup>g</sup>	118 <sup>g</sup>	114 <sup>g</sup>				158 <sup>h</sup>		74 <sup>i</sup>

[a] In solution with water  $\approx 5 \text{ g L}^{-1}$ . [b] After H<sub>2</sub>S removal. [c] Net of the purge gas. [d] Contains H<sub>2</sub>S. [e] No distillation. [f] Based on 50% w.b. moisture biomass. [g] Ref. case Steam drying. [h] Ref. case Product gas - zeroEl. [i] Ref. case CH<sub>4</sub> +H<sub>2</sub> - zeroEl.

## 4.2 Investment and Production Cost

The investment cost for a commercial scale ABP plant has been estimated based on the analysis of the investments cost of the GoBiGas plant [31]. The aggregated investment and scale factors used are given below and the estimated investment cost as a function of plant production capacity is shown as a function of plant scale (production capacity) in Fig. 4.2. Data is also shown from commercial combined heat and power (CHP) plants based on fluidized beds as these constitute a relevant reference with recently built large-scale plants using biomass as feedstock. The data based on CHP plants shows that features such as fuel flexibility and performance are prioritized differently and therefore the specific investment cost for CHP plants do not follow the expected economy of scale. In fact, the specific investment cost for CHP plants are impacted much more by other factors than plant scale. With this in mind, it should be emphasized that the estimations below apply to stand-alone plants with priorities regarding the performance, high safety level and fuel flexibility corresponding to the GoBiGas plant.

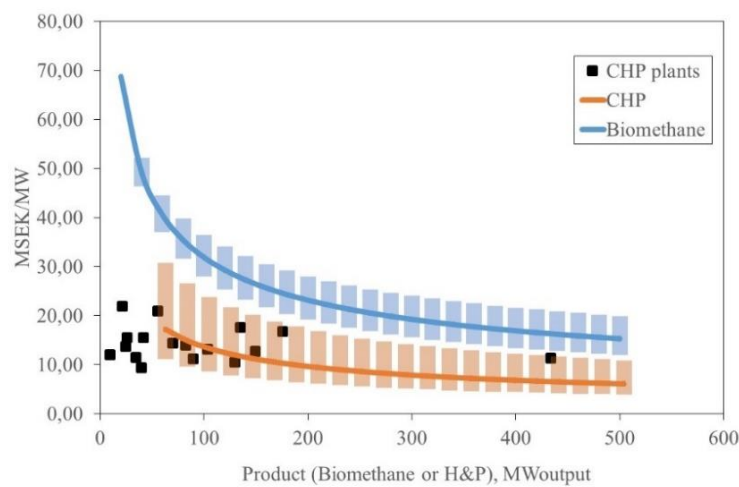

Figure 4.2: Initial investment cost per capacity (MW product) for advanced biofuel (Biomethane) and CHP plants. The black dots represent the costs for a number of CHP plants built in Sweden after 2010.

The estimated depreciation cost (presented per MWh of product as biogas is traded on this basis in Sweden) is shown in Fig 4.3, where the bars indicate uncertainties in the scale factors. A strong decrease is gained by increasing the production capacity to about 150–200 MW while the decrease with further increase is more moderate.

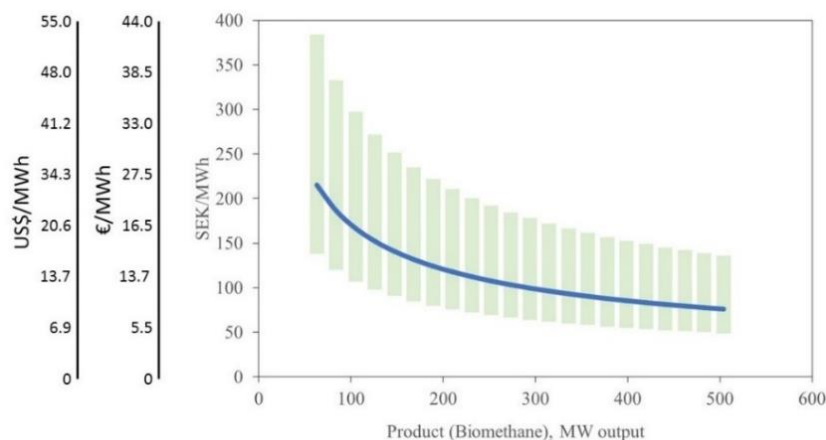

Figure 4.3: Depreciation cost for biomethane including non-technical uncertainties divided by the expected production during the technical lifetime of the plant (20 years). Exchange rates: SEK 9.1 per EUR 1.0 (average exchange rate during the project) and USD 1.25 per EUR 1.0.[31]

The investment and operational cost for GoBiGas were analyzed to define a 20 MW reference plant and the aggregated results are presented in table 4.2. For this reference, project-specific costs have been subtracted and the costs related to consumables have been minimized as justified by the technical review of the process [15]. For more details see [31].

Table 4.2: Aggregated costs and scale-factors for different costs related to the operation of an ABP plant. The untreated cost estimates based on GoBiGas are included in gray text to indicate estimated changes. From [31].

Cost	Scale Factor	Capital costs for the GoBiGas plant	Estimated capital costs for a 20 MW reference plant			
<i>Initial Investment Cost, <math>C_{Inv, 20MW}</math></i>		<i>SEK million/20 MW</i>	<i>SEK million/20 MW</i>			
- Reactor systems	0.68	238	238			
- Auxiliary equipment and project costs	0.44	1,141	955			
- Steam cycle, fuel handling and drying	0.67	-	182			
<b>Total</b>		<b>1,380</b>	<b>1,375</b>			
<i>Operating costs excluding feedstock, <math>C_{ope, 20MW}</math></i>		<i>SEK/MWh<sup>1</sup> <math>C_{ope, 20MW} / (P_{20 MW FLH})</math></i>	<i>SEK/MWh<sup>1</sup> <math>C_{ope, 20MW} / (P_{20 MW FLH})</math></i>			
Personnel	0.10	181	181			
Maintenance	0.67	89	89			
Consumables and waste products	1.00	131.5	55.1			
- Electricity		37.6	0 <sup>2</sup>			
- RME		31.7	0 <sup>2</sup>			
- Activated carbon/BTX removal		8.5	10			
- Other		53.6	45.1			
Other costs	0.67	26.5	26.5			
<b>Total</b>		<b>428.0</b>	<b>351.6</b>			
	<i>Cost of ingoing fuel SEK/MWh</i>	<i>Fuel-related costs in SEK/MWh biogas</i>				
<i>Feedstock cost</i>		<i>Dry biomass to biomethane efficiency %, LHV</i>				
		55	60	65	<b>70</b>	75
Pellets <sup>2</sup>	250	448	411	379	<b>352</b>	329
Forest residue <sup>3</sup>	170	276	253	234	<b>217</b>	203
Recovered wood fuels <sup>4</sup>	110	194	178	164	<b>153</b>	143
Recovered wood fuels <sup>4</sup>	50	88	81	75	<b>69</b>	65

<sup>1</sup> Based on 8,000 full-load hours per year and a 20 MW biomethane production plant.

<sup>2</sup> Based on expected changes for commercial plants, suggested by the technical review of GoBiGas [15]

<sup>3</sup> Pellets, 10% moisture

<sup>4</sup> Forest residue, 45% moisture.

<sup>5</sup> Recovered wood, 18% moisture.

Fuel-related costs constitute a large proportion of total production cost and changing to a cheaper feedstock is thereby an efficient way of reducing production costs. As shown above in section 3, the plant could be operated with both steam-wood based fuel, such as wood pellets, and fuels containing bark, such as forest residues and shredded bark. Ahlström et al [27] has estimated and illustrated fuel-related costs for an APB plant. Figure 4.4 shows that fuel cost can be reduced considerably when using forest residues or bark instead of wood pellets, and how fuel moisture and process efficiency affect this trend.

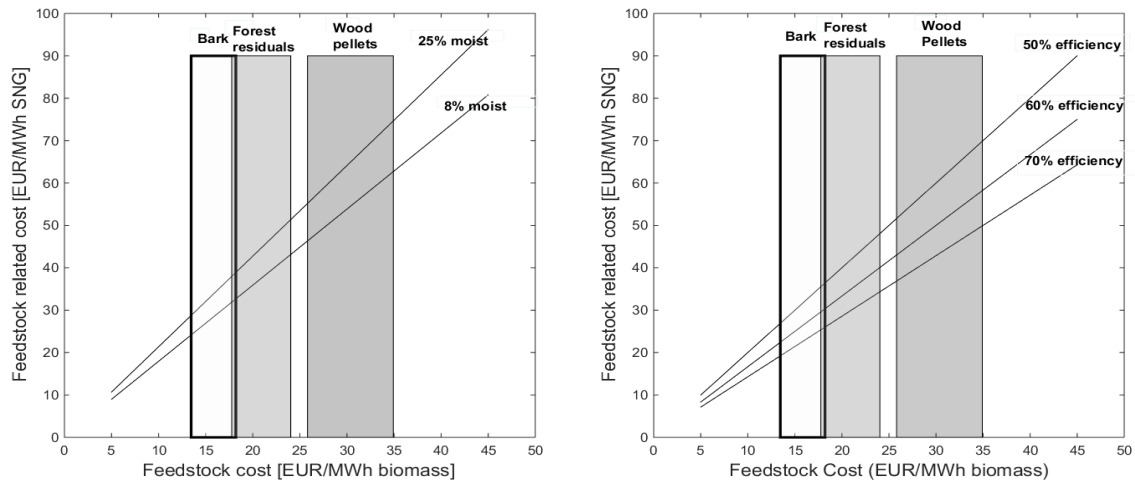

Figure 4.4: Fuel-related costs as a function of fuel costs and moisture content, left, and gasifier efficiency, right. Typical fuel prices in Sweden are indicated by shaded areas. From J. M. Ahlström et al [27].

Based on these findings, total production costs for a commercial-scale plant for the production of biomethane via gasification were estimated, assuming: 1) the use of forest residue dried to about 10% moisture as fuel; 2) plant performance of 70%; and 3) availability of 8,000 hours per year. The estimated production cost for different scales are summarized in Table 4.3.

Table 4.3. Estimated total production cost (including investment costs) for biomethane, using forest residues for feedstock (SEK 170/MWh based on the lower heating value of received fuel with 45% moisture), 8,000 FLH, 20-year economic lifetime, and 70% plant efficiency [31].

	Reference plant 20 MW SEK/MWh	Commercial plant 100 MW SEK/MWh	Commercial plant 200 MW SEK/MWh
Capital cost, depreciation	430	199	145
Capital cost, interest (5%)	258	120	87
Development cost	43	20	15
Operation costs (excluding feedstock)	352	166	132
Feedstock cost	217	217	217
Total cost	1300	722	596

By constructing a stand-alone plant with a production capacity of 200 MW, production cost can be reduced to about SEK 600/MWh, which could be economically viable with a developed biogas market. For a stand-alone plant with 100 MW production, such as was planned for the second phase of the GoBiGas project, production costs are more than SEK 720/MWh. A biogas spot market would be an advantage, the better to know what an economically viable production cost might be, thus reducing the risks related to an investment decision for stand-alone ABP plants. Because the investment for a 200 MW plant would be in the order of SEK 5,000 million, economic risks need to be kept at a minimum.

Note that there is great potential to reduce both the investment and operating costs by integrating this type of production with other existing industries, which could enable more cost-effective production even on a smaller scale. Compromises regarding performance, fuel flexibility, and availability could significantly reduce the investment cost. However, how this affects operating costs must be carefully considered. Using cheaper feedstock such as recovered wood or waste is also an attractive option for the future development of this type of technology.

## 5 Concluding Remarks

The GoBiGas plant was the first of its kind where biomass was converted into biomethane via gasification on an industrial scale. The purpose of the project was to demonstrate that high quality biomethane can be produced on a commercial scale corresponding to 100 MW or more with this technology. Ambitious goals were set for the performance of the demonstration plant to make it as representative as possible to a commercial-scale, stand-alone plant for the production of biomethane via gasification.

When Göteborg Energi started the GoBiGas project, the (municipally owned) company asked the Swedish state and optional commercial partners to share the risk – without success. Although the state (Swedish Energy Agency) invested SEK 222 million in the project, all other risks were borne by Göteborg Energi. Despite the high risk identified, Göteborg Energy decided to assume full liability and the main risks for the GoBiGas project on its own, seeing that the potential benefits of the technology were worth the risk.

The demonstration goals were to reach a production capacity of 20 MW with a biomass to biomethane efficiency of 65%, a plant efficiency of 90%, and production of 8,000 hours/year. The goal of a production capacity of 20 MW was met using wood pellets as fuel. Efficiency based on the conversion of biomass to biomethane was up to 63% based on the lower heating value and dry, ash-free fuel. The goal of 65% efficiency could be reached through optimization of the process and the technology review of the process shows that it is technically feasible to reach an efficiency of 70% in this type of process without major changes to the concept. In order to reach such a high efficiency and achieve stable operation in this type of plant, biomass drying must be included.

During the demonstration, biomass to biomethane efficiency was prioritized over total plant efficiency, which also includes district heating. As the waste heat used for district heating can be increased with a lower biomass to biogas efficiency, the goal of 90% plant efficiency could probably be reached, but as biomethane is a more valuable product than district heating, this is an inferior goal compared to the main purpose of producing biomethane.

The goal of 8,000 hours/year availability was not reached during the project and the longest period of continuous operation was 1,750 hours, operating with wood pellets. Adjustments made to the process and operational strategy during the demonstration improved greatly during the project and the goal of 8,000 hours of operation per year in this type of plant is considered possible with further improvements and increased redundancy in the process. For the GoBiGas plant, the major limiting factor for availability was related to fuel feeding, feedstock properties and the product gas cooler.

Several lessons learned during the project are described in this report, which concludes that the technology for specific components can be considered mature and ready for commercialization. However, there is still a great potential for improvement in the overall process. And future development should be focused on how the different process steps should be combined and how particular process steps affect upstream and downstream equipment. For example, the product gas cooler at GoBiGas was designed in a manner that demanded high quality gas from the gasifier; in fact the gas quality required was at times even outside the design specifications for methanation. Thus matching the design specifications of the different parts of the process will be crucial in a future plant, as will the experience from the GoBiGas project and ongoing research into this matter. Another example where the gas deviated from the design specifications is the absence of sulfur components in the gas after tar cleaning systems where sulfur cleaning steps including an H<sub>2</sub>S scrubber were installed. A better understanding of the sulfur components in the gas could potentially make room for a simplified process.

Production costs at the GoBiGas plant have been analyzed in detail with the conclusion that during continuous operation with wood pellets, production costs (excluding the investment cost) of SEK 800-1,000/MWh are within the range of those projected during the project feasibility phase. However, with lower-than-expected energy prices, particularly for biogas, profitable production could not be achieved. Thus, to make this type of process profitable, production cost has to be reduced or the value of biogas increased. Note that for a plant of commercial scale, capital cost must be included in the production costs as well. Due to the high production cost related to biomethane prices, the new management and the new board, decided in 2018 to stop the project.

One option for decreasing production cost is to build a plant with higher production capacity and to achieve a production cost under SEK 600/MWh – a plant of at least 200 MW production capacity that uses forest residues as feedstock will be necessary. The investment cost for such a stand-alone plant would be in the order of SEK 5,000 million based on the analysis of GoBiGas.

Other options for biorefineries like the GoBiGas plant to reach profitability include combining this type of production with existing industries and infrastructure to reduce both investment and personnel costs, the use of waste as feedstock or finding a more profitable end product than biomethane.

A big driving force behind the GoBiGas project was reducing greenhouse gas emissions by producing an advanced biofuel that could substitute natural gas. Results have shown that a greenhouse gas reduction factor well above 80% can be achieved with this type of technology, which is a significant reduction. This could easily be further enhanced by reducing the emissions related to collecting and transporting feedstock to the plant or by making use of the CO<sub>2</sub> separated from the gas in the process to achieve a reduction factor close to 100%. Minimizing methane slip is an important aspect when producing methane, as the methane itself has strong greenhouse gas impact. The GoBiGas demonstration has shown that methane slip corresponding to less than 0.04% of production can be achieved in this type of biorefinery.

The quality of the gas from GoBiGas has been analyzed and it has been demonstrated that the produced gas is of high quality and fulfills the European standard for injection of biogas into the grid.

## 6 References

1. Hofbauer, H., et al., *Biomass CHP plant Güssing-A success story*. 2003: na.
2. Ståhl, K. and M. Neergaard, *IGCC power plant for biomass utilisation, Värnamo, Sweden*. Biomass and Bioenergy, 1998. **15**(3): p. 205-211.
3. Thunman, H., *GoBiGas demonstration – a vital step for a large-scale transition from fossil fuels to advanced biofuels and electrofuels*, I. 978-91-88041-15-9, Editor. 2018.
4. Thunman, H., A. Larsson, and M. Hedenskog, *Commissioning of the GoBiGas 20MW Bio-methane Plant, in tcbiomass 2015*. 2015, Chicago.
5. Kuba, M., F. Kirnbauer, and H. Hofbauer, *Influence of coated olivine on the conversion of intermediate products from decomposition of biomass tars during gasification*. Biomass Conversion and Biorefinery, 2017. **7**(1): p. 11-21.
6. Marinkovic, J., et al., *Characteristics of olivine as a bed material in an indirect biomass gasifier*. Chemical Engineering Journal, 2015. **279**: p. 555-566.
7. Berdugo Vilches, T., et al., *Comparing active bed materials in a dual fluidized bed biomass gasifier: olivine, bauxite, quartz-sand, and ilmenite*. Energy & Fuels, 2016. **30**(6): p. 4848-4857.
8. Kuba, M., et al., *Influence of controlled handling of solid inorganic materials and design changes on the product gas quality in dual fluid bed gasification of woody biomass*. Applied Energy, 2018. **210**: p. 230-240.
9. Nguyen, H.N., M. Seemann, and H. Thunman, *Fate of Polycyclic Aromatic Hydrocarbons during Tertiary Tar Formation in Steam Gasification of Biomass*. Energy & Fuels, 2018. **32**(3): p. 3499-3509.
10. Israelsson, M., T. Berdugo Vilches, and H. Thunman, *Conversion of condensable hydrocarbons in a dual fluidized bed biomass gasifier*. Energy & Fuels, 2015. **29**(10): p. 6465-6475.
11. Larsson, A., et al., *Using ilmenite to reduce the tar yield in a dual fluidized bed gasification system*. Energy & Fuels, 2014. **28**(4): p. 2632-2644.
12. Koppatz, S., C. Pfeifer, and H. Hofbauer, *Comparison of the performance behaviour of silica sand and olivine in a dual fluidised bed reactor system for steam gasification of biomass at pilot plant scale*. Chemical Engineering Journal, 2011. **175**: p. 468-483.
13. Rabou, L.P., et al., *Tar in biomass producer gas, the Energy research Centre of the Netherlands (ECN) experience: an enduring challenge*. Energy & Fuels, 2009. **23**(12): p. 6189-6198.
14. McKee, D.W., *Mechanisms of the alkali metal catalysed gasification of carbon*. Fuel, 1983. **62**(2): p. 170-175.
15. Thunman, H., et al., *Advanced biofuel production via gasification—lessons learned from 200 man-years of research activity with Chalmers' research gasifier and the GoBiGas demonstration plant*. Energy Science & Engineering, 2018. **6**(1): p. 6-34.
16. Marinkovic, J., *Choice of bed material: a critical parameter in the optimization of dual fluidized bed systems*. 2016: Chalmers University of Technology.
17. Held, J., *Biomass Product Gas Reforming Solutions*. 2018.
18. Larsson, A., M. Hedenskog, and H. Thunman, *Monitoring the bed material activation in the GoBiGas–gasifier*. Nordic Flame Days Copenhagen, 2015.
19. Larsson, A., Thunman, H., Seemann, M., Breitholtz, C., Gunnarsson, I., *Development of a methodology for measurements at the GoBIGAS gasifier*. 2018: [www.energiforsk.se](http://www.energiforsk.se).
20. Berdugo Vilches, T., *Operational strategies to control the gas composition in dual fluidized bed biomass gasifiers*, in *Energy Technology*. 2018, Chalmers University of Tehcnology.
21. Glarborg, P., *Hidden interactions—Trace species governing combustion and emissions*. Proceedings of the combustion institute, 2007. **31**(1): p. 77-98.
22. Gall, D., et al., *Online measurements of alkali and heavy tar components in biomass gasification*. Energy & Fuels, 2017. **31**(8): p. 8152-8161.
23. Larsson, A., et al., *Evaluation of performance of industrial-scale dual fluidized bed gasifiers using the chalmers 2–4-MWth gasifier*. Energy & Fuels, 2013. **27**(11): p. 6665-6680.

24. Howes, T., *The EU's new renewable energy Directive (2009/28/EC)*. The new climate policies of the European Union: internal legislation and climate diplomacy, 2010. **15**(117): p. 3.
25. Alamia, A., et al., *Performance of large-scale biomass gasifiers in a biorefinery, a state-of-the-art reference*. International Journal of Energy Research, 2017. **41**(14): p. 2001-2019.
26. Alamia, A., et al., *Efficiency Comparison of Large-Scale Standalone, Centralized, and Distributed Thermochemical Biorefineries*. Energy Technology, 2017. **5**(8): p. 1435-1448.
27. Ahlström J.M., A., A., Larsson, A., Breitholtz, C., Harvey, S., Thunman, H., *Bark as feedstock in dual fluidized bed gasification – operability, efficiency and economics*. submitted to International Journal of Energy Research, 2018.
28. Kuba, M. and H. Hofbauer, *Experimental parametric study on product gas and tar composition in dual fluid bed gasification of woody biomass*. Biomass and Bioenergy, 2018. **115**: p. 35-44.
29. Pallares, D., Johansson, R., Larsson, A., Lundberg, L., Thunman, H., *Char conversion indirect gasification in fluidized beds*. 2017: [www.energiforsk.se](http://www.energiforsk.se).
30. Lundberg, L., et al., *Influence of surrounding conditions and fuel size on the gasification rate of biomass char in a fluidized bed*. Fuel Processing Technology, 2016. **144**: p. 323-333.
31. Thunman, H., Gustavsson, C., Larsson, A., Gunnarsson, I., Tengberg, F., *Economic assessment of advanced biofuel production via gasification using real cost data from GoBiGas* submitted to Energy Science & Engineering, 2018.
32. Larsson, A., *Fuel conversion in a dual fluidized bed gasifier*. 2014: Chalmers University of Technology.

## Appendix 1 – Experiences and lessons learned

The following appendix was compiled to summarize experience from the project and from the operation of the GoBiGas process. Note that the GoBiGas plant is the first of its kind where biomass gasification is combined with methanation on an industrial scale and it was built to demonstrate the concept. Thus some of the challenges encountered and described below are related to the scale-up and integration of different process steps. Even though a great many experiences and challenges are described below, the challenges are considered minor and can be overcome with conventional technology. The demonstration has proven that with minor adjustments and a slightly different focus during the design phase of the project, building a commercial plant based on GoBiGas technology should be technically feasible. Contributors to this Appendix and their positions are listed in table A1.1.

*Table A1.1: This information was compiled by the listed personnel.*

Name	Position (Spring 2018)	Company
Anna Hultén, MSc	Process Engineer	
Anton Larsson, Ph.D	Development Engineer	Göteborg Energi AB
Claes Breitholtz, Ph.D		Valmet AB
Claes Henningsson, MSc		Valmet AB
Dan Åkerlund	Electricity Engineer	Göteborg Energi AB
Fredrik Berggren	Operating Engineer	Göteborg Energi AB
Göran Eriksson	Maintenance Engineer	Göteborg Energi AB
Henrik Larsson	Pipe- and Engineering	Göteborg Energi AB (Consultant)
Joakim Bergfors	Plant Manager	Göteborg Energi AB
Lars Gustafsson	Pipe- and Engineering	Göteborg Energi AB (Consultant)
Staffan Andersson, MSc	Process Engineer and commissioning manager	Göteborg Energi AB (Consultant)
Torben Granbom	Automation Engineer	Göteborg Energi AB (Consultant)

To compile this summary and include the most important design changes and lessons learnt from the GoBiGas plant, a number of questions were answered by the participants for the most significant process units:

1. Are there any relevant experiences or challenges related to operation of the unit?
2. Are there any relevant experiences or challenges related to the maintenance of the unit?
3. What changes have been made to the original design of the unit?
4. What further improvements to unit functionality would be positive for the GoBiGas operation?
5. Are there any particular features regarding this unit that should be specifically considered in the future development of a commercial plant of similar type as GoBiGas?

## List of Content in Appendix 1

1	Storage and Transport of Wood Pellets .....	III
2	Internal Fuel Handling .....	IV
2.1	Lock hoppers.....	IV
2.2	Dosing Bin.....	IV
2.3	Feeding and Transport Screws.....	V
3	Reception, Storage and Transport of Chipped Fuels .....	V
4	Gasification.....	VI
4.1	Gasification Reactor.....	VI
4.2	Bed Material Shut Between the Reactors .....	VII
4.3	Combustion reactor.....	VII
4.4	Cyclone and Siphon .....	VIII
4.5	Post-Combustion Chamber (PCC).....	VIII
5	Product Gas Cooling and Cleaning.....	IX
5.1	Product Gas Cooler .....	IX
5.2	Product Gas Filter.....	IX
5.3	First Tar Cleaning Step – RME Scrubber and Reservoir.....	X
5.4	Product Gas Fan .....	X
5.5	Product Gas Cooler 2.....	XI
5.6	Product Gas Analyzer.....	XI
6	Feeding System – Bed Material and Particles from Product Gas Filter.....	XII
7	Flue Gas Train .....	XII
8	Combustion Air.....	XIII
9	Condensed Water Treatment and Steam Generation.....	XIII
10	Ash Handling System .....	XIV
10.1	Bottom Ash extraction from the Gasification Reactor .....	XIV
10.2	Fly Ash.....	XV
11	Second Tar Cleaning Step – Adsorption Beds with Activated Carbon.....	XV
12	Syngas Compressor .....	XVI
13	Gas Conditioning.....	XVII
13.1	Hydrogenation of Olefins .....	XVII
13.2	COS Conversion and Chloride Guard.....	XVII
13.3	H <sub>2</sub> S scrubber.....	XVII
13.4	Sulfur Guard.....	XVIII
13.5	Water Gas Shift Reaction.....	XVIII
13.6	Pre-methanation.....	XIX
13.7	CO <sub>2</sub> scrubbing.....	XIX

13.8 CO <sub>2</sub> Compression .....	XX
14 Methanation.....	XX
15 Driers.....	XXI
16 Auxiliary Systems .....	XXI
16.1 Steam Generation for the Methanation Section of the Plant .....	XXI
16.2 Hot water system.....	XXI
16.3 Process Water Treatment.....	XXII
16.4 Flare .....	XXII
16.5 Electrical systems.....	XXIII
17 Instrumentation.....	XXIII
18 General Remarks .....	XXIV

## 1 Storage and Transport of Wood Pellets

Operational experience and challenges	<ul style="list-style-type: none"> <li>• Dust tends to accumulate in the pellets silos and when operating with a low level in the silo the fraction of dust fed to the process increases.</li> <li>• Accumulation of dust on the level switch sensors causing false indications of high levels in the silo. Redundant sensors and sensor purging should be applied to avoid unnecessary stops.</li> <li>• There was a fire in the main pellet silo that was related to dust.</li> <li>• Leakage of dust from the transporters could not be avoided, requiring regular cleaning in safety-classified areas.</li> <li>• Thermocouples used to monitor the temperature in the transporter as part of the fire safety system failed several times due to mechanical stress.</li> <li>• The scale used to measure fuel flow through the conveyer requires a moment to self-calibrate during start-up and with intermittent feeding to lock hoppers (see section 2.1) this causes a delay at each filling.</li> <li>• Position indicators at all of the fuel feeding system gables clogged with dust from the fuel, which could also hinder their function.</li> </ul>
Maintenance experience and challenges	<ul style="list-style-type: none"> <li>• Dust filters had to be cleaned at least twice per year.</li> </ul>
Design changes	<ul style="list-style-type: none"> <li>• Switch purging was installed.</li> <li>• Restoration of the silo after the fire and installation of additional safety measure to avoid future fires.</li> </ul>
Further potential for improvement	<ul style="list-style-type: none"> <li>• Redundant sensors can increase fuel feed availability.</li> <li>• Improved maintenance accessibility.</li> </ul>
Features to consider for commercialization	<ul style="list-style-type: none"> <li>• To reach the level of availability required for a biorefinery, fuel feed availability is crucial. A completely redundant fuel feed system should be considered to enable service during operation.</li> </ul>

## 2 Internal Fuel Handling

### 2.1 Lock hoppers

Operational experience and challenges	<ul style="list-style-type: none"> <li>Gas from gasification leaked upstream through the fuel feed with tar deposits and combustible gases as a consequence. This was related to leaking valves in the inlet and outlet fuel streams to the lock hoppers.</li> <li>It is difficult to have a system that is optimized for operation with both pelletized and chipped fuel.</li> </ul>
Maintenance experience and challenges	<ul style="list-style-type: none"> <li>The bursting disc should be located sheltered from rain to reduce the maintenance required due to dust and moisture.</li> </ul>
Design changes	<ul style="list-style-type: none"> <li>Changed valves to ball valves with inflatable packings.</li> <li>Continuous purge downstream of the lock hoppers was installed to decrease the risk of gas leaking upstream through the feed system.</li> </ul>
Further potential for improvement	<ul style="list-style-type: none"> <li>Separate systems for wood pellets and wood chips.</li> <li>Find a method of avoiding the requirement for valve gas tightness tests before purging the fuel lock hoppers.</li> <li>Analysis of the composition of the off-gases from lock hopper purging could enable process optimization, decreasing purge time and the use of purge gas.</li> <li>Improve the spread of fuel in the lock hoppers to better utilize lock hopper volume, especially when using chipped fuel.</li> </ul>
Features to consider for commercialization	<ul style="list-style-type: none"> <li>Redundant systems.</li> <li>Separate systems for pelletized and chipped fuels if both are to be used.</li> </ul>

### 2.2 Dosing Bin

Operational experience and challenges	<ul style="list-style-type: none"> <li>The rather small dosing bin volume made regulation of the level more sensitive than desired when using chipped fuel.</li> <li>In operations using bark there was a tendency to form arches which hindered a steady flow of fuel.</li> <li>The chain used to rotate the reclaimers (feeding screws) was built with a cut link. This failed during operation causing the whole plant to stop.</li> </ul>
Maintenance experience and challenges	<ul style="list-style-type: none"> <li>The design did not allow maintenance while the process was warm, forcing a complete gasifier reactor cool-down before opening the dosing bin. These prolonged operational disturbances related to the dosing bin.</li> </ul>
Design changes	<ul style="list-style-type: none"> <li>Reconstruction of the feeding system to avoid cut links in the chain rotating the reclaimers.</li> <li>The spacing above the reclaimers was increased to avoid clogging.</li> <li>The shaft below the reclaimers was rebuilt as it had a lower diameter than the rest of the fuel feeding system, which resulted in clogging when operating with chipped fuel.</li> </ul>
Further potential for improvement	<ul style="list-style-type: none"> <li>Mechanical equipment to break fuel arches formed in the dosing bin.</li> <li>Improved spread of the fuel to utilize the volume better; improved level indication.</li> </ul>
Features to consider for commercialization	<ul style="list-style-type: none"> <li>Redundant systems and the ability to perform maintenance during operation to improve process availability.</li> </ul>

### 2.3 Feeding and Transport Screws

Operational experience and challenges	<ul style="list-style-type: none"> <li>• Deposits formed on the feeding screw, pushing the fuel into the bubbling bed (see main report for more details).</li> <li>• Feeding of ash together with the fuel should be avoided as this catalyzes the buildup of deposits.</li> </ul>
Maintenance experience and challenges	<ul style="list-style-type: none"> <li>• The cooling water connection to the rotating screw had to be changed once a year.</li> <li>• High screw blade attrition in connection to the process; hard overlay welding was added. Even so, new overlay had to be added several times per year. With time, the material also got spruced hindering proper welding after about 2 years, requiring a new screw.</li> </ul>
Design changes	<ul style="list-style-type: none"> <li>• Improved purge (see lock hoppers).</li> <li>• Different feeding screw designs were tested with e.g. different distances between the blades, blade angles and blade cooling. However, this gave no measurable difference regarding availability.</li> <li>• Rails attached to the mantel that were intended to guide the screw were removed as they were suspected of increasing the risk of sudden spikes in the torque required to rotate the screw.</li> <li>• A stronger motor and transmission were installed to cope with the higher torque requirement.</li> </ul>
Further potential for improvement	<ul style="list-style-type: none"> <li>• Rebuilding to on-bed feeding e.g. like those commonly used in bubbling bed combustors.</li> </ul>
Features to consider for commercialization	<ul style="list-style-type: none"> <li>• On-bed feeding should be considered and availability must be emphasized.</li> </ul>

### 3 Reception, Storage and Transport of Chipped Fuels

Operational experience and challenges	<ul style="list-style-type: none"> <li>• Intermittent lock hopper operation in the internal fuel feeding system means that external fuel feeding has to be designed for a higher nominal flow than the average required by the plants.</li> <li>• Operational problems in the process complicated commissioning of the fuel feed and vice versa. Commissioning without connection to the process could have improved commissioning and reduced plant down time.</li> <li>• When switching from wood chips to shredded bark, process return is required.</li> <li>• Variations in the moisture content in the fuel cause variations in the process.</li> </ul>
Maintenance experience and challenges	<ul style="list-style-type: none"> <li>• Lack of ventilation in the fuel silo caused a lot of moisture and in time corrosion on the fuel silo roof.</li> </ul>
Design changes	
Further potential for improvement	<ul style="list-style-type: none"> <li>• A drier and a method to control fuel moisture at delivery. With a drier there, it would also be useful with online measurement of fuel moisture downstream of the drier.</li> </ul>
Features to consider for commercialization	<ul style="list-style-type: none"> <li>• Use bigger margins between the average required flow and the design flow.</li> <li>• Tests at GoBiGas show it to be very difficult to attain stable operation without a drier.</li> <li>• More redundancy should be included to improve availability.</li> </ul>

## 4 Gasification

### 4.1 Gasification Reactor

Operational experience and challenges	<ul style="list-style-type: none"><li>• High concentrations of tar in the gas produced caused downstream problems (see main report) before a method for controlling gas quality was established.</li><li>• De-fluidized regions in the conical section of the process.</li><li>• With a high differential pressure over the bubbling bed in the gasifier, problems appeared in both the feeding screw and the combustion reactor.</li><li>• A design without cooled reactor walls gives high heat loss to surroundings.</li></ul>
Maintenance experience and challenges	<ul style="list-style-type: none"><li>• The fluidization nozzles were attached to long vertical pipes that became deformed, with less uniform fluidization as a result.</li><li>• Backflow of sand through the nozzles due to insufficient sealing over the nozzles.</li><li>• The conically shaped section of the reactor required a lot of maintenance during the inspection each year compared to the vertical walls with significantly less problems.</li><li>• No hatch to enter the bottom of the gasifier means that the whole bottom cone including all the nozzles has to be removed at each inspection.</li></ul>
Design changes	<ul style="list-style-type: none"><li>• The number of hooks to keep the refractory in place was doubled in the conical section of the reactor.</li><li>• Bottom ash feeding system was added; see separate section.</li></ul>
Further potential for improvement	<ul style="list-style-type: none"><li>• A thicker insulating layer to reduce the temperature of the reactor shell to slightly above 100 C would reduce heat losses and maintenance requirements.</li><li>• Increased protective layer on the refractory.</li><li>• Fluidization of all parts of the gasifier bed section.</li><li>• Redundant bed pressure drop metering.</li></ul>
Features to consider for commercialization	<ul style="list-style-type: none"><li>• Consider cooled reactor shell to reduce heat losses to the surroundings and the risk of high temperatures in the shell, and avoid conical and round reactor walls in such a case.</li><li>• Consider a welded bottom section and instead have a small hatch to minimize maintenance efforts.</li></ul>

#### 4.2 Bed Material Shut Between the Reactors

Operational experience and challenges	<ul style="list-style-type: none"> <li>Due to clogging of the nozzles in the shut, the flow of bed material between the reactors sometimes became limited. The clogging was caused by bed material backflow, which was probably more severe when switching from nitrogen fluidization (start-up) to steam (continuous operation)</li> </ul>
Maintenance experience and challenges	<ul style="list-style-type: none"> <li>Significant damage to the refractory, which had to be repaired during the inspection each year. This could be partly related to the tension that arises between the gasifier and the combustor, especially during start and stop.</li> </ul>
Design changes	<ul style="list-style-type: none"> <li>The number of gaskets was minimized by welding some of the flanges.</li> <li>New nozzles (Valmet standard) were installed with about 5 times higher seal function and the number of nozzles were decreased to less than half the initial amount. This fixed the clogging problems.</li> </ul>
Further potential for improvement	<ul style="list-style-type: none"> <li>Weld as many flanges as possible.</li> </ul>
Features to consider for commercialization	<ul style="list-style-type: none"> <li>The length and angle of the shut affect combustor bed height, and this must be carefully considered to avoid too high a bed section in the combustor. Increasing the length and angle of the shut should be avoided.</li> <li>The use of a loop seal instead of a shut should be considered</li> </ul>

#### 4.3 Combustion reactor

Operational experience and challenges	<ul style="list-style-type: none"> <li>The ratio between bed height and the diameter of the combustion region is low with a consequent risk of fluidized bed slugging. Slugging causes large vibrations and a large amount of bed material to be thrown up through the reactor entering both burners and air injectors. Decreased bed heights in both the gasifier and combustor (as these are coupled) helped. However, slugging was especially difficult to avoid during start-up with the current design where the expansion zone was probably located too high.</li> <li>The start burner was problematic, some of the problems may be related to slugging in the reactor, but also to quality problems with the burner itself.</li> <li>The nozzle for the pumped mixture of RME, tar, water and dissolved potassium carbonate was eroded, but it seems that a nozzle is not really needed.</li> <li>Erosion of some of the fluidization air nozzles, which was related to high velocities and narrow nozzle spacing, so that they caused erosion on each other.</li> </ul>
Maintenance experience and challenges	<ul style="list-style-type: none"> <li>Sand had to be cleaned from the secondary and tertiary air feeders regularly.</li> <li>Confined space around equipment placed in between the combustor, gasifier and cyclone complicated maintenance.</li> <li>There is no hatch to access the bottom of the gasifier, which means that the whole bottom cone including all the nozzles must be removed at each inspection.</li> </ul>
Design changes	<ul style="list-style-type: none"> <li>Backflow valves were added on the product gas lines to minimize the amount of sand backflow and the pipes were changed to cope with higher temperatures, as backflow sand could be up to 900 C.</li> </ul>

	<ul style="list-style-type: none"> <li>All the fluidization nozzles were changed to a model with tighter seals and lower gas velocity, avoiding attrition problems and sand backflow.</li> </ul>
Further potential for improvement	<ul style="list-style-type: none"> <li>Minimizing the number of connections for air and combustible gases to the combustion reactor to minimize complexity and maintenance.</li> </ul>
Features to consider for commercialization	<ul style="list-style-type: none"> <li>Consider a separate system for feeding biomass to the combustor, reducing the need for natural gas during start-up and product gas recirculation during operation.</li> <li>Include a hatch for maintenance and weld a fixed bottom to the reactor.</li> <li>Consider including flue gas recirculation to improve process control.</li> </ul>

#### 4.4 Cyclone and Siphon

Operational experience and challenges	<ul style="list-style-type: none"> <li>High temperatures during start-up as natural gas tends to burn late in the process with low fluidization velocity during start-up.</li> <li>Fluidization nozzle clogging caused poor bed material throughput.</li> </ul>
Maintenance experience and challenges	<ul style="list-style-type: none"> <li>The siphon connected to the cyclone has a refractory separation wall and cracks were detected.</li> <li>Refractory protection layer attrition was detected.</li> </ul>
Design changes	<ul style="list-style-type: none"> <li>Change of nozzles to a Valmet standard.</li> </ul>
Further potential for improvement	<ul style="list-style-type: none"> <li>Improved design including a hatch to simplify maintenance.</li> </ul>
Features to consider for commercialization	<ul style="list-style-type: none"> <li>The separation wall in the siphon should be reinforced compared to the current design.</li> <li>Include a hatch for maintenance and weld a fixed bottom to the reactor.</li> </ul>

#### 4.5 Post-Combustion Chamber (PCC)

Operational experience and challenges	<ul style="list-style-type: none"> <li>CO emissions</li> <li>Temperature too low with the original design.</li> </ul>
Maintenance experience and challenges	<ul style="list-style-type: none"> <li>Erosion at the PCC inlet due to high velocities.</li> <li>Erosion of the refractory protection layer.</li> </ul>
Design changes	<ul style="list-style-type: none"> <li>A burner was added to enable control of the temperature in the PCC burning recirculated product gas, and a new thermocouple for the control loop. This enabled a limitation of emissions; however, the large amount of gas required entails a plant efficiency penalty.</li> <li>The input of off-gases from methanation was moved to an earlier point in the process.</li> </ul>
Further potential for improvement	<ul style="list-style-type: none"> <li>Being able to control where the flow from the evaporator enters the PCC could improve the NO<sub>x</sub> limitation as this flow contains NH<sub>3</sub>.</li> </ul>
Features to consider for commercialization	<ul style="list-style-type: none"> <li>Scaling up the PCC might not be required at all, at least the design should be simplified to improve operation and maintenance.</li> </ul>

## 5 Product Gas Cooling and Cleaning

### 5.1 Product Gas Cooler

Operational experience and challenges	<ul style="list-style-type: none"> <li>• Cooling media temperature is crucial for the whole process as it sets the demands of gas quality. The possible temperature is also linked to the type of particle filter used downstream.</li> <li>• Clogging with tar when gas quality is low.</li> <li>• There is no backup system to pump water through the cooler and during a power outage there is risk of damage to the heat exchanger</li> <li>• The metal downstream of the cooler was eroded by particles.</li> </ul>
Maintenance experience and challenges	
Design changes	<ul style="list-style-type: none"> <li>• Improved design to reduce the risk of overheating the material in the cooler by adding a steam vent and level indicator.</li> </ul>
Further potential for improvement	
Features to consider for commercialization	<ul style="list-style-type: none"> <li>• Consider switching the hot water system to a steam loop, e.g. with a horizontal boiler in the product gas cooler.</li> </ul>

### 5.2 Product Gas Filter

Operational experience and challenges	<ul style="list-style-type: none"> <li>• The filter was not installed as an assembly, instead all the functions were connected to the main control system and in combination with the ATEX Exi classification, this led to a slightly slower pulsing procedure than desired as capacitors had to be used.</li> <li>• The filter pulsing valves did not function properly when operating with CO<sub>2</sub>, while there were no problems with N<sub>2</sub>.</li> <li>• When operating with a high tar load due to poor activation of the bed material in the gasifier, there were some problems with the formation of arches of material.</li> <li>• On one occasion, oxygen in the filter just after filter stop, led to glowing material in two of the filters which burned a hole. The following start-up particles could therefore pass the filter, causing problems in downstream process steps.</li> </ul>
Maintenance experience and challenges	<ul style="list-style-type: none"> <li>• The filters were changed every two years.</li> </ul>
Design changes	<ul style="list-style-type: none"> <li>• Increased design pressure to 200 mbar</li> </ul>
Further potential for improvement	<ul style="list-style-type: none"> <li>• A local control box to operate the filter pulsing valves with shorter, better pulses and reduce the consumption of purge gas.</li> </ul>
Features to consider for commercialization	<ul style="list-style-type: none"> <li>• Specifying a higher design pressure, about 500 mbar, during design. This would probably be appropriate for the whole gasification section</li> <li>• Consider using ceramic, high-temperature filters instead.</li> </ul>

### 5.3 First Tar Cleaning Step – RME Scrubber and Reservoir

Operational experience and challenges	<ul style="list-style-type: none"> <li>Demister clogging (probably due to naphthalene crystals), especially as the temperature is decreased. It can be cleaned by occasionally spraying a solvent on the demister; however, there is still too much clogging when gas temperature out of the scrubber is below 30 C.</li> <li>Poor separation of water and oil phase during start-up so that the water cannot be reused during the first 12–24 hours of operation.</li> <li>When replacing all the RME in the scrubbing system with completely fresh RME, scrubber cleaning function decreased significantly. It took about 1 week before regular RME scrubber function could be attained, which is about the same time estimated for the scrubber to reach a steady state operation in terms of tar concentration in the RME.</li> <li>Winter additives in the RME must be avoided to achieve good separation between water and oil. Further, separation is better with slightly lower pH and worse with higher pH.</li> <li>The demand for fresh RME was about 50% higher than design in order to limit the amount of entrained large tar components following the gas to the downstream adsorption beds. This shows how important it is to analyze the whole gas cleaning section when designing the specific components and optimizing the operation.</li> </ul>
Maintenance experience and challenges	<ul style="list-style-type: none"> <li>RME puts a strain on the gaskets and if spilled, it dissolves the epoxy-based floor protection layer.</li> </ul>
Design changes	<ul style="list-style-type: none"> <li>An extra nozzle was added to spray the demister with RME when the pressure drop becomes excessive.</li> <li>A level indicator was added to monitor the level of the transition layer between water and oil phase in the reservoir to improve system monitoring.</li> </ul>
Further potential for improvement	<ul style="list-style-type: none"> <li>Investigate if regeneration of the RME can be performed to minimize the consumption.</li> </ul>
Features to consider for commercialization	<ul style="list-style-type: none"> <li>RME constitutes about 5–7% of operating cost excl. the cost of personnel. Finding an alternative with lower operational cost should be a priority.</li> </ul>

### 5.4 Product Gas Fan

Operational experience and challenges	<ul style="list-style-type: none"> <li>This functioned very well considering the challenging gas containing traces of both tar and RME.</li> <li>The min flow recirculation makes it possible to switch from nitrogen fluidization in the gasifier to steam before starting the fuel feed. This reduces fluctuation when starting gasification.</li> </ul>
Maintenance experience and challenges	<ul style="list-style-type: none"> <li>Not possible to drain the fan satisfactorily during operation.</li> </ul>
Design changes	
Further potential for improvement	<ul style="list-style-type: none"> <li>A convenient option for fan draining during operation. The drained liquids should be added to the RME scrubber reservoir.</li> </ul>
Features to consider for commercialization	

### 5.5 Product Gas Cooler 2

Operational experience and challenges	<ul style="list-style-type: none"> <li>• The cooler the gas when entering the downstream adsorption beds, the more can be adsorbed per kg of adsorbent.</li> <li>• The temp. of the cooling media could be kept as low as 2 C above the temp of the gas exiting the RME-scrubber without fouling problems.</li> </ul>
Maintenance experience and challenges	
Design changes	
Further potential for improvement	<ul style="list-style-type: none"> <li>• Could be made bigger to reduce gas outlet temperature while retaining the same cooling media temperature.</li> </ul>
Features to consider for commercialization	

### 5.6 Product Gas Analyzer

Operational experience and challenges	<ul style="list-style-type: none"> <li>• Clogging with tar</li> <li>• Leakage of product gas</li> </ul>
Maintenance experience and challenges	<ul style="list-style-type: none"> <li>• Service during operation is not possible.</li> </ul>
Design changes	<ul style="list-style-type: none"> <li>•</li> </ul>
Further potential for improvement	<ul style="list-style-type: none"> <li>• A redundant analyzer to enable service during operation.</li> <li>• Analysis of larger hydrocarbons could improve the monitoring and gas cleaning operation.</li> </ul>
Features to consider for commercialization	<ul style="list-style-type: none"> <li>• Redundancy</li> </ul>

## 6 Feeding System – Bed Material and Particles from Product Gas Filter

Operational experience and challenges	<ul style="list-style-type: none"> <li>The ring gap nozzle used for feeding the material into the combustion reactor suffered both clogging and erosion and its initial function of generating a sub pressure in the feeding system could not be sustained.</li> <li>The particles from the product gas filter contain limestone, char, ash soot, tar and bed material and this mixture tended to become very packed if stored for extended periods. Thus, saving material from one operational period to the next was not an option if the stop was more than one day.</li> </ul>
Maintenance experience and challenges	<ul style="list-style-type: none"> <li>Emptying the intermediate storage for particles from the product gas filter was a problem as the use of a regular industrial vacuum cleaner is inappropriate because the material contains a lot of combustibles that are hot when collected and sometimes smolder in the container.</li> <li>Improved vibrators were installed to avoid problems with the formation of arches and improve level measurement.</li> </ul>
Design changes	<ul style="list-style-type: none"> <li>Increased ring gap nozzle dimensions and removed safety shut down based on pressure in the feeding system. This was based on a second SIL-analysis where purging was determined to be safe enough.</li> <li>The level sensor based on microwave measurements was switched to a fork-based instrument as the former was too sensitive to dust.</li> </ul>
Further potential for improvement	<ul style="list-style-type: none"> <li>Greater intermediate storage volume.</li> </ul>
Features to consider for commercialization	

## 7 Flue Gas Train

Operational experience and challenges	<ul style="list-style-type: none"> <li>Much lower deposits than expected in the first empty shaft, which led to lower superheated steam and air temperatures.</li> </ul>
Maintenance experience and challenges	<ul style="list-style-type: none"> <li>Only small amounts of deposits; a sonic cleaning system was sufficient.</li> </ul>
Design changes	
Further potential for improvement	<ul style="list-style-type: none"> <li>Additional refractory in the first empty shaft to increase superheated steam and air temperature to about 400 C.</li> </ul>
Features to consider for commercialization	<ul style="list-style-type: none"> <li>By optimizing the pre heating of the flows to the DFB gasifier such as fluidization steam for the gasification reactor or air to the combustion reactor. heat demand can be reduced and efficiency increased.</li> </ul>

## 8 Combustion Air

Operational experience and challenges	<ul style="list-style-type: none"> <li>• Sand backflow in the combustion reactor.</li> </ul>
Maintenance experience and challenges	
Design changes	
Further potential for improvement	<ul style="list-style-type: none"> <li>• Increased pre-heat temperature.</li> </ul>
Features to consider for commercialization	<ul style="list-style-type: none"> <li>• A separate fan for fluidization air would be beneficial.</li> </ul>

## 9 Condensed Water Treatment and Steam Generation

Operational experience and challenges	<ul style="list-style-type: none"> <li>• Clogging of the steam generator due to impurities in reused water when there were disturbances in the operation of the RME scrubbing system.</li> <li>• Entrainment of droplets from the steam generator.</li> <li>• High noise when venting steam.</li> </ul>
Maintenance experience and challenges	
Design changes	<ul style="list-style-type: none"> <li>• Installation of a cyclone demister on the boiler outlet to remove droplets.</li> <li>• Installation of a muffler on the steam venting pipes.</li> <li>• Measurement of turbidity of the water from the evaporator to monitor quality and control when the water can be used for steam generation or when it has to be treated as process wastewater (mainly during start-up of the process.)</li> </ul>
Further potential for improvement	<ul style="list-style-type: none"> <li>• Improved cleaning of the water upstream of the boiler, e.g. a ceramic oil separation filter or a centrifuge.</li> <li>• Improved system for draining heavy tar components from the system</li> <li>• System for on-site incineration of wastewater, for instance through the option of pumping it to the combustion reactor.</li> </ul>
Features to consider for commercialization	<ul style="list-style-type: none"> <li>• Improved cleaning, probably a centrifuge.</li> </ul>

## 10 Ash Handling System

### 10.1 Bottom Ash extraction from the Gasification Reactor

Operational experience and challenges	<ul style="list-style-type: none"> <li>• Not required when operating with ash-poor fuel such as wood pellets.</li> <li>• Clogging due to formation of very tough deposits formed by bed material, ash and moisture in the gasification reactor bottom cone. This forms if the system is stopped for extended periods. Continuous operation is preferred.</li> <li>• CO emissions from extraction system venting.</li> <li>• Condensation of steam in the extraction system.</li> <li>• Some ammonia when moist gas enters the extraction system from the gasifier where ammonia is formed from the nitrogen in the fuel.</li> <li>• When operating the plant with recovered wood containing nails, the nails passed the gasifier and a lot of nails were found in the bottom of the combustor.</li> <li>• Due to a high heavy metals content in the olivine ore, the ashes cannot be utilized.</li> </ul>
Maintenance experience and challenges	
Design changes	<ul style="list-style-type: none"> <li>• Purging with N<sub>2</sub> was added to decrease the amount of CO and H<sub>2</sub>O that entered from the gasifier.</li> <li>• A pulse injection system was installed to break up clogs in the bottom cone.</li> </ul>
Further potential for improvement	<ul style="list-style-type: none"> <li>• Sieving and recirculation of bed material particles can decrease costs related to ash and fresh olivine.</li> <li>• If possible, avoid extraction from the gasifier and instead extract from the combustor as this would be much more convenient. Alternatively, ventilation gases should be rerouted to the process combustion section.</li> </ul>
Features to consider for commercialization	<ul style="list-style-type: none"> <li>• Sieving and recirculation of bed material particles can decrease costs related to ash and fresh olivine.</li> <li>• If possible avoid extraction from the gasifier and instead extract from the combustor as this would be much more convenient. Alternatively, ventilation gases should be rerouted to the process combustion section.</li> </ul>

## 10.2 Fly Ash

Operational experience and challenges	<ul style="list-style-type: none"> <li>• Due to a high heavy metals content in the olivine ore, the ashes cannot be utilized.</li> <li>• Recirculation of coarse ash to the gasifier together with fuel should be avoided as it increases the formation of deposits on the feeding screw.</li> <li>• Ash recirculation to the gasifier also increases the risk of deposits on the product gas cooler and the ash should instead be recirculated to the combustor.</li> </ul>
Maintenance experience and challenges	
Design changes	<ul style="list-style-type: none"> <li>• Redesign of the cell feeder to enable continuous feeding</li> <li>• New reception site for different particles that can be feed to the gasifier.</li> </ul>
Further potential for improvement	<ul style="list-style-type: none"> <li>• Separation and recirculation of large particles to the combustion reactor.</li> </ul>
Features to consider for commercialization	<ul style="list-style-type: none"> <li>• Separation and recirculation of large particles to the combustion reactor.</li> </ul>

## 11 Second Tar Cleaning Step – Adsorption Beds with Activated Carbon

Operational experience and challenges	<ul style="list-style-type: none"> <li>• Initially limited plant load as capacity was lower than required.</li> <li>• Fouling by tar components downstream of the adsorption beds. Not known how these components can get past carbon beds in series.</li> <li>• The batch-wise operation of the adsorption beds causes fluctuation in downstream reactors as they adsorb e.g. olefins when newly regenerated but not after a few minutes' operation.</li> <li>• The off-gases from regeneration are fed to the post-combustion chamber, but the major shift in heating value and flow causes large variations in the post-combustion chamber and the flue gas train. This in turn affects the operation of both the gasifier and the hot water system.</li> <li>• Superheating the steam dose not significantly aid carbon regeneration as the majority of the energy comes from condensing steam, and the regeneration temperature was restricted to the steam condensation temperature.</li> <li>• Complex system control sequences provided challenges both in the optimization of the operation and in detecting flaws during commissioning.</li> <li>• Both BTX component and naphthalene have to be desorbed during regeneration to maintain bed function.</li> <li>• The adsorption front of Benzene is rather sharp and a guard bed is not required; instead a Benzene analyzer is better.</li> </ul>
Maintenance experience and challenges	<ul style="list-style-type: none"> <li>• The carbon was replaced a few times a year based on the volume flow of gas that had passed the beds. External personnel trained to work in inert atmospheres performed the replacement.</li> <li>• Carbon could be replaced during operation of the plant at somewhat reduced load.</li> <li>• A mesh was installed between inert particles and the carbon so that the inert particles could be re used.</li> </ul>

Design changes	<ul style="list-style-type: none"> <li>• The sequence and operational strategy were changed to increase carbon bed capacity, this is described in more detail in the main report.</li> <li>• The regeneration sequence had to be optimized to minimize fluctuation in the PCC rather than optimizing regeneration.</li> <li>• An online analyzer (a GC-FID) was installed to monitor the concentration of Benzene downstream of the beds to detect when it was time to switch beds.</li> <li>• The pressure of the steam used for regeneration was increased to improve regeneration.</li> <li>• More thermocouples were installed to enable temperature gradient monitoring through the bed.</li> </ul>
Further potential for improvement	<ul style="list-style-type: none"> <li>• Increasing the difference in temperature of the gas during adsorption and the steam during desorption would increase bed capacity.</li> <li>• A method other than one based on flow to detect when the pre-adsorber is saturated with tar components larger than naphthalene and to determine when to replace the carbon.</li> <li>• Condensation of the off-gases from regeneration would decrease fluctuations throughout the process as well as increase efficiency.</li> <li>• Improved carbon bed heating during regeneration.</li> <li>• Enable on-site high-temperature regeneration or combustion of used carbon.</li> </ul>
Features to consider for commercialization	<ul style="list-style-type: none"> <li>• If possible, carbon beds should not be used as the main step for large-scale cleaning of BTX components.</li> </ul>

## 12 Syngas Compressor

Operational experience and challenges	<ul style="list-style-type: none"> <li>• Clogging of a mesh filter during commissioning due to small concentrations of tar components downstream of the adsorption beds.</li> <li>• When an adsorption bed with fresh activated carbon is put into operation for the first time, it initially also adsorbs very light hydrocarbons, causing a rapid and significant change in gas density, causing the compressor to surge which in turn causes gasification to stop as gas has nowhere to go because the compressor is surging.</li> <li>• Generally good operation and no problems with vibrations.</li> </ul>
Maintenance experience and challenges	
Design changes	
Further potential for improvement	
Features to consider for commercialization	<ul style="list-style-type: none"> <li>• a piston compressor should be considered to reduce investment costs in plants similar in size to GOBiGas, i.e. 20 MW or smaller.</li> <li>• Consider whether both a product gas fan and a compressor are necessary.</li> </ul>

## 13 Gas Conditioning

### 13.1 Hydrogenation of Olefins

Operational experience and challenges	<ul style="list-style-type: none"> <li>• Much lower concentrations of H<sub>2</sub>S in the gas than expected and therefore some sulfur had to be added.</li> <li>• The operation of this reactor was affected significantly when switching adsorbent beds as this affects the concentration of olefins.</li> <li>• Olefin concentrations were in general lower than expected but the temperature increase over the reactor was still greater than expected, indicating unexpected exothermic reactions.</li> <li>• The olefin concentration in the gas from gasification is related to methane concentration, and with a higher activation of bed material, the olefin concentration decreases.</li> <li>• Gas analysis before and after this reactor indicates that some reactions are taking place other than just the desired hydrogenation.</li> </ul>
Maintenance experience and challenges	<ul style="list-style-type: none"> <li>• Faster deactivation than expected, which could be related to the lack of sulfur in the gas.</li> </ul>
Design changes	<ul style="list-style-type: none"> <li>• Installation of a feeding system for adding Sulfrzol 54 to the gas upstream of the reactor.</li> </ul>
Further potential for improvement	<ul style="list-style-type: none"> <li>• If possible, switch to a catalyst that is not as sensitive to the concentration of sulfur-containing compounds in the gas.</li> </ul>
Features to consider for commercialization	<ul style="list-style-type: none"> <li>• If possible, switch to a catalyst that is not as sensitive to the concentration of sulfur-containing compounds in the gas.</li> </ul>

### 13.2 COS Conversion and Chloride Guard

Operational experience and challenges	<ul style="list-style-type: none"> <li>• No operational challenges and no signs of Cl-guard depletion.</li> <li>• Concentrations of COS at the detection limit make it difficult to evaluate the performance of this process step.</li> </ul>
Maintenance experience and challenges	
Design changes	
Further potential for improvement	<ul style="list-style-type: none"> <li>• Thermocouples in the bed to monitor the temperature gradient.</li> </ul>
Features to consider for commercialization	<ul style="list-style-type: none"> <li>• Evaluate if these steps are required, especially the Cl guard.</li> </ul>

### 13.3 H<sub>2</sub>S scrubber

Operational experience and challenges	<ul style="list-style-type: none"> <li>• The amine attained a dark green to black color and contained some particles. The particles were very small and also difficult to separate for analysis but still large enough to eventually clog the filter in the circulating flow.</li> <li>• Incoming gas temperature was decreased to slightly lower than amine temperature to minimize the risk of foaming.</li> </ul>
Maintenance experience and challenges	<ul style="list-style-type: none"> <li>• Heat exchanger clogging due to FeCO<sub>3</sub> deposits. The source of these deposits is unclear.</li> <li>• Similar deposits were also found in the adsorbent tower.</li> <li>• Clogging of pumps and mesh filters with glass fiber material originating from gaskets in the system's towers.</li> </ul>

Design changes	<ul style="list-style-type: none"> <li>• Filter housing switched to stainless steel to potentially reduce the formation of FeCO<sub>3</sub>.</li> <li>•</li> </ul>
Further potential for improvement	<ul style="list-style-type: none"> <li>• Complement the mechanical filter with an activated carbon filter to reduce foaming tendencies.</li> </ul>
Features to consider for commercialization	<ul style="list-style-type: none"> <li>• Evaluate if this process step can be omitted to have only one scrubbing system.</li> <li>• Consider using freshwater free from dissolved oxygen.</li> </ul>

#### 13.4 Sulfur Guard

Operational experience and challenges	<ul style="list-style-type: none"> <li>• Sulfur was only measured at ppb levels after the guard and there was no apparent consumption of the guard.</li> </ul>
Maintenance experience and challenges	
Design changes	
Further potential for improvement	
Features to consider for commercialization	

#### 13.5 Water Gas Shift Reaction

Operational experience and challenges	<ul style="list-style-type: none"> <li>• Temperature spikes during start-up.</li> <li>• A lower inlet temperature yields higher temperatures in the lower reactor sections; this was mostly a problem during start-up. A higher inlet temperature gives a smoother temperature profile.</li> </ul>
Maintenance experience and challenges	<ul style="list-style-type: none"> <li>• Some deactivation detected, but not more than expected.</li> </ul>
Design changes	<ul style="list-style-type: none"> <li>• Safety shutdown was added to avoid excessively high temperature spikes.</li> <li>• The reactor design temperature was increased in agreement with the manufacturer.</li> </ul>
Further potential for improvement	<ul style="list-style-type: none"> <li>•</li> </ul>
Features to consider for commercialization	<ul style="list-style-type: none"> <li>• The transient behavior during start-up should be included in the HASOP.</li> </ul>

### 13.6 Pre-methanation

Operational experience and challenges	<ul style="list-style-type: none"> <li>This reactor is closely interconnected with the shift reactor, which makes start-up in particular more complex.</li> <li>Significant deactivation was noticed, but the lack of operating hours makes it difficult to determine whether the deactivation rate differs from design.</li> <li>Occasionally higher concentrations of olefins in the inlet gas.</li> </ul>
Maintenance experience and challenges	<ul style="list-style-type: none"> <li>The Inconel pipe from the outlet of the reactor suffered from metal dusting and creep. Pipes of this material are expensive and their number should be kept to a minimum.</li> </ul>
Design changes	
Further potential for improvement	<ul style="list-style-type: none"> <li>Using refractory or combining the reactor and a heat exchanger in one vessel to avoid the need for Inconel pipes.</li> <li>Enable inlet temperature control separate from the operation of the upstream shift reactor.</li> </ul>
Features to consider for commercialization	

### 13.7 CO<sub>2</sub> scrubbing

Operational experience and challenges	<ul style="list-style-type: none"> <li>The temperature of the incoming gas was decreased to slightly lower than amine temperature to minimize the risk of foaming.</li> <li>This process step was the limiting factor for the plant (after redesign of the carbon beds), which was related to a high gas CO<sub>2</sub> content rather than the scrubber itself. The high CO<sub>2</sub> content can be related to oxygen transport from the combustor to the gasifier and a high flow of recirculated CO<sub>2</sub> to purge the fuel feed and product gas filter.</li> <li>Foaming in the low pressure flash tower.</li> <li>The amine, which is activated with piperazine attained a pink tone due to dissolved metal ions.</li> <li>Fluctuation in hot water system temperature caused disturbances in the operation of the CO<sub>2</sub> scrubber.</li> <li>With a pressure drop over downstream process steps lower than anticipated in the design, gas flow was throttled to increase pressure to design level as this improves adsorption.</li> </ul>
Maintenance experience and challenges	<ul style="list-style-type: none"> <li>Pump clogging due to glass fiber material originating from gaskets in the systems towers.</li> <li>Problems with Teflon gaskets; graphite gaskets should be used instead.</li> <li>When using activated amine (addition of piperazine) it is especially important to train all personnel on site on how to handle it.</li> </ul>
Design changes	<ul style="list-style-type: none"> <li>Some carbon steel parts were changed to stainless steel to avoid corrosion.</li> </ul>
Further potential for improvement	<ul style="list-style-type: none"> <li>Existing mechanical filters should be complemented with active carbon filters to minimize foaming.</li> <li>Improved cooling and drying of the CO<sub>2</sub> outlet stream to simplify compression of this flow.</li> </ul>
Features to consider for commercialization	<ul style="list-style-type: none"> <li>Evaluate whether two scrubbing systems are really needed</li> <li>Oxygen-free feed water can be used to reduce corrosion</li> <li>Increase design capacity to cope with uncertainties in the amount of CO<sub>2</sub> in the product gas.</li> <li>If possible, avoid splitting adsorption into two towers to reduce investment cost.</li> </ul>

### 13.8 CO<sub>2</sub> Compression

Operational experience and challenges	<ul style="list-style-type: none"> <li>• Significant operational problems occurred due to corrosion in the first stage of the compressor, which could be related to the formation of carbonic acid in the moist gas.</li> <li>• Erosion occurred in the second compressor stage due to corroded material from the first stage.</li> <li>• Large pressure variations downstream of the compressor caused by the intermittent use of CO<sub>2</sub> in the compressor.</li> <li>• Delivered as an assembly, there were some challenges with integration in the main operating system.</li> </ul>
Maintenance experience and challenges	<ul style="list-style-type: none"> <li>• The interiors of both compressor stages were changed twice, which added unexpected cost.</li> </ul>
Design changes	<ul style="list-style-type: none"> <li>• Improved pressure regulation upstream of the compressor to reduce pressure fluctuation and allow for more stable compressor operation.</li> <li>• The compressor purge gas was changed from CO<sub>2</sub> to N<sub>2</sub> to ensure it is completely dry.</li> </ul>
Further potential for improvement	<ul style="list-style-type: none"> <li>• Different material in the compressor that is less sensitive to corrosion by carbonic acid.</li> <li>• Unused CO<sub>2</sub> should be vented to the atmosphere instead of the post-combustion chamber where it cools, forcing the combustion of additional product gas. The CO<sub>2</sub> contains very low concentrations of impurities and if not used it should be vented.</li> </ul>
Features to consider for commercialization	

### 14 Methanation

Operational experience and challenges	<ul style="list-style-type: none"> <li>• This part of the process worked very well overall.</li> <li>• Lower pressure drop than expected, which affected upstream CO<sub>2</sub> separation.</li> </ul>
Maintenance experience and challenges	<ul style="list-style-type: none"> <li>• Inconel pipes (see Pre-methanator for further explanation)</li> <li>• Some tendency for deactivation in the first reactor; however, the number of operating hours is too few to determine whether this is above design.</li> </ul>
Design changes	<ul style="list-style-type: none"> <li>• New safety function to avoid high temperatures during start-up.</li> </ul>
Further potential for improvement	
Features to consider for commercialization	

## 15 Driers

Operational experience and challenges	<ul style="list-style-type: none"> <li>• Drier cooling is performed with moist gas, which could reduce capacity a little.</li> <li>• The interconnection with methanation caused some fluctuations in the end product, e.g. the off-gas from heating during regeneration is fed to methanation. While convenient, this causes minor fluctuations in gas composition.</li> <li>• Occasional high moisture content peaks downstream of the driers have appeared for unknown reasons, seemingly at random.</li> </ul>
Maintenance experience and challenges	<ul style="list-style-type: none"> <li>• Complex sequence makes operation and maintenance more challenging.</li> </ul>
Design changes	<ul style="list-style-type: none"> <li>•</li> </ul>
Further potential for improvement	<ul style="list-style-type: none"> <li>• Recirculation of dried gas to the driers was enabled to reduce fluctuations in the end products.</li> </ul>
Features to consider for commercialization	<ul style="list-style-type: none"> <li>• Separation of the regeneration loop from the main process to avoid fluctuations in the composition of produced gas.</li> </ul>

## 16 Auxiliary Systems

### 16.1 Steam Generation for the Methanation Section of the Plant

Operational experience and challenges	<ul style="list-style-type: none"> <li>• This was intended as a start-up boiler used to heat the process temps in methanation; however, the high demand for steam, in particular for the regeneration of the carbon beds, has forced continuous operation.</li> </ul>
Maintenance experience and challenges	
Design changes	<ul style="list-style-type: none"> <li>•</li> </ul>
Further potential for improvement	<ul style="list-style-type: none"> <li>• Delivered as an assembly, interconnection with the main operational control system should be improved to reduce complexity.</li> </ul>
Features to consider for commercialization	<ul style="list-style-type: none"> <li>• The need for a start-up boiler could perhaps be avoided in a larger plant.</li> <li>• The generation of more steam and a more automated heating process could reduce plant start-up time.</li> </ul>

### 16.2 Hot water system

Operational experience and challenges	<ul style="list-style-type: none"> <li>• Both Jacobs and Valmet were involved in the design of this system, which runs through both the gasification and methanation sections of the plant. This increased the complexity of the hot water system design.</li> <li>• Significant fluctuations in temperature due to intermittent operation of some parts of the process, especially regeneration of the carbon beds. The fluctuations in hot water temperature in turn cause fluctuations in the operation of several of the methanation reactors and should be minimized to stabilize gas composition.</li> </ul>
Maintenance experience and challenges	

Design changes	<ul style="list-style-type: none"> <li>• A safety measure was introduced to avoid high temperatures in the product gas cooler (see Product gas cooler).</li> </ul>
Further potential for improvement	<ul style="list-style-type: none"> <li>• A backup system to secure the circulation of water during power outages.</li> </ul>
Features to consider for commercialization	<ul style="list-style-type: none"> <li>• On a larger scale, steam could be used.</li> </ul>

### 16.3 Process Water Treatment

Operational experience and challenges	<ul style="list-style-type: none"> <li>• The most important process parameter was the temperature in the stripper tower to ensure the removal of light aromatic hydrocarbons, especially Benzene.</li> <li>• Process heating requires operation of the plant gasification section, which complicates operations during start-up and stop.</li> <li>• Low concentrations of polyaromatic compounds appeared in the process water.</li> </ul>
Maintenance experience and challenges	<ul style="list-style-type: none"> <li>• Significant amount of deposits in the heat exchanger, which had to be cleaned several times per year.</li> </ul>
Design changes	<ul style="list-style-type: none"> <li>• Enabled circulation and water treatment heating even when the rest of the process is out of operation.</li> </ul>
Further potential for improvement	<ul style="list-style-type: none"> <li>• Redundant heat exchanger, pumps and filters.</li> </ul>
Features to consider for commercialization	<ul style="list-style-type: none"> <li>• Count on the possibility of some PAH compounds in the water.</li> </ul>

### 16.4 Flare

Operational experience and challenges	<ul style="list-style-type: none"> <li>• Challenges with ice formation in the ejectors for the pilot burners.</li> <li>• The use of separate pipes for gas from the gasification and the methanation sections in the plant has proven very convenient.</li> <li>• Auxiliary fuel (natural gas) was required to enable carbon bed regeneration when the plant is not in operation.</li> <li>• The flare was designed for a worst case flow, which is well above normal flows during process start-up, and there is optimization potential in using a smaller flare.</li> </ul>
Maintenance experience and challenges	
Design changes	<ul style="list-style-type: none"> <li>• Added tracing of natural gas distribution to the pilot burners.</li> </ul>
Further potential for improvement	
Features to consider for commercialization	<ul style="list-style-type: none"> <li>• Make a detailed analysis of the potential maximum flow accounted for in the design to avoid oversizing the flare and to improve combustion and reduce investment cost.</li> </ul>

## 16.5 Electrical systems

Operational experience and challenges	<ul style="list-style-type: none"> <li>• There are no service switches located at the equipment and electricity has to be cut in the motor control center (MCC).</li> <li>• Lack of signals from the MCC to indicate positions as well as relevant values, makes maintenance complex.</li> </ul>
Maintenance experience and challenges	<ul style="list-style-type: none"> <li>• Lack of local service, especially for frequency modulators, complicates maintenance.</li> <li>• More focus on the availability of replacement parts and material for the electrical system during the project phase could have improved availability and simplified maintenance.</li> <li>• More extensive self-monitoring and clearer specifications for all electrical equipment during commissioning of the electrical systems would probably have reduced operational challenges and the need for maintenance during plant commissioning.</li> </ul>
Design changes	<ul style="list-style-type: none"> <li>• Improved MCC monitoring.</li> </ul>
Further potential for improvement	<ul style="list-style-type: none"> <li>•</li> </ul>
Features to consider for commercialization	<ul style="list-style-type: none"> <li>• If possible, use more local manufacturers to improve service.</li> </ul>

## 17 Instrumentation

Operational experience and challenges	<ul style="list-style-type: none"> <li>• The whole GoBiGas plant was designed based on the ATEX Exi standard. This affected some functions negatively, e.g., product filter pulsing became too slow; it should have been installed as an assembly instead.</li> <li>• Different verification methods for SIL classification in gasification and methanation led to a significant difference in the level of redundancy in different parts of the system. This in turn is due to very different ambitions regarding the availability of different parts of the process (see general remarks).</li> <li>• Interconnection of interlock and SIL circuits in the plant gasification section yielded very large blocks for interlocks in the safety system, which complicated SIL tests.</li> </ul>
Maintenance experience and challenges	<ul style="list-style-type: none"> <li>• Clogging in the pressure measurement connections in gasification sections where there are a lot of particles in the gas. In these sections, mono-blocks should be avoided to simplify maintenance.</li> <li>• One manufacturer was used for all valves, and this has simplified maintenance significantly.</li> <li>• All digital signals followed the Namur standard, which simplified both commissioning and maintenance.</li> </ul>
Design changes	<ul style="list-style-type: none"> <li>• Fluidization in storage silos was introduced to improve level measurements.</li> </ul>
Further potential for improvement	<ul style="list-style-type: none"> <li>• Condensate containers were used to measure the volume flow of steam. During start-up, nitrogen is used instead of steam, and then the water level can change causing a faulty measurement. To avoid this, manual filling of water should be made possible.</li> </ul>
Features to consider for commercialization	<ul style="list-style-type: none"> <li>• More redundancy, especially in the gasification section.</li> <li>• Better synchronization of availability goals for different parts of the process.</li> </ul>

## 18 General Remarks

- The gasification system was designed with the aim of about 6 months of continuous operation and inspection for about 1 month per year, while methanation was designed to operate continuously for 4 years, which is standard for petrochemical industries. This discrepancy led to a very big difference in the level of redundancy in the different parts of the process. When including a process step with high temperature and refractory material, like the gasifier, a yearly inspection is required. Based on this, the level of redundancy in methanation could have been significantly reduced to lower the investment cost. At the same time, this type of biorefinery has a long start-up time and should be operated about 8,000 hours a year; therefore, gasification section availability is especially important and should be increased for a commercial plant.
- GoBiGas plant start-up takes in general about 5–7 days from cold to delivery of gas to the grid. Heating of the gasification process is limited by the temperature gradient of the refractory and some additional time for the temperature to stabilize, in all about 18–24 hours. Gasification start-up should be made fast to avoid operating at low load as this increases the risk of clogging the product gas cooler. However, before starting methanation, gas quality after the RME-scrubber should be stabilized, and the gasifier is usually operated for about 24 hours before starting the first methanation step. The methanation process is pre-heated and started in several steps and usually takes at least 72 hours. Methanation start-up time in particular could be decreased by increasing automation or the work force during start-up, and by enabling the different process steps to be heated in parallel. In a commercial plant, we would recommend a process simulator to train operators, as the process is rather complex.
- With more than one gasifier connected to the same methanation section, availability could be greatly increased and start-up time reduced by always operating methanation with at least one gasifier in operation.
- Using as many local manufacturers as possible would simplify service-related issues.
- When buying assemblies, it is important (if possible) to match electrical equipment and instruments with the standard used in the rest of the plant to make both commissioning and maintenance more convenient.
- When sharing auxiliary systems such as cooling water with other industries, redundant systems should be considered as independent of the availability of other plants.



## Appendix 2 – Research Projects Connected to GoBiGas

During the GoBiGas project, several research projects were conducted to analyze general and specific questions concerning gasification and biofuels. Some of the projects involved measurements at the plant and were partly financed in kind from operation of the GoBiGas plant. Other projects were based on data from the project but conducted by academic partners and financed mainly by funding from the Swedish state or European research programs. Below is a list of research projects directly connected to GoBiGas.

### **Optimization and increased energy efficiency in indirect gasification gas cleaning 2016–19**

Performed by Henrik Ström, Adam Jareteg, Srdjan Sasic and Henrik Thunman, Chalmers University of Technology; Anton Larsson, Anna-Karin Nilsson and Ingemar Gunnarsson, Göteborg Energi AB.

Funded by the Swedish Energy Agency (Project number P41245-1) and Göteborg Energi

The aim of this project is to enable robust operation and regeneration of gas cleaning processes based on packed-bed adsorbers with activated carbon, and to investigate whether major components adsorbed in the bed (e.g. benzene) could be separated afterwards. Comprehensive mathematical models of the adsorption process and multiphase flow through the packed bed have been developed and are being extended to provide the tools necessary to perform large-scale optimization. Extensive data sets from the operation of the packed-bed adsorbers at the GoBiGas plant using various arrangements and strategies have been accumulated to provide ample opportunity for model validation and evaluation of different operational principles. The output from this project is also applicable to other gasification techniques and to other chemical processes involving significant gas cleaning steps.

Report – Will be finished before the end of 2019.

### **Coated heat exchangers as self-cleaning producer gas condensers 2017–18**

Performed by Henrik Ström, Dario Maggiolo, Srdjan Sasic and Henrik Thunman, Chalmers University of Technology; Olga Santos and Mats Andersson, Alfa Laval Lund AB; Anton Larsson, Anna-Karin Nilsson and Ingemar Gunnarsson, Göteborg Energi AB.

Funded by the Swedish Energy Agency (Project number P42206-1), Alfa Laval Lund AB and Göteborg Energi AB.

The project comprised development and testing of the potential for a coated-plate heat exchanger to act as a cooler for product gas from a steam-blown indirect gasifier. The heat exchanger plates were either conventional or modified by coating to become more hydrophilic or more hydrophobic. Experimental evaluations were performed at the Chalmers research gasifier and at GoBiGas. From both experimental trials, it was evident that coated plates, in contrast to conventional plates, may significantly resist tar fouling. Comprehensive numerical simulations have revealed that a self-cleaning effect can be achieved when the steam condensation on the plates produces small and motile droplets that help protect the surfaces and transport away impurities. Guidelines for design and optimization have been established on the basis of the experimental and numerical results. The use of self-cleaning plate heat exchangers, as proven and investigated in this project, has enormous potential to contribute to more efficient heat recovery in generic processes involving the cooling of hydrocarbon-rich gases.

Report – Will be finished before the end of 2018.

## **Development of a Methodology for Measurements at the GoBiGas gasifier 2016–18**

Performed by Chalmers University of Technology (CTH), Göteborg Energi AB (GE), Valmet AB (V) and the authors are Anton Larsson (CTH, GE), Henrik Thunman (CHT), Martin Seemann (CHT), Claes Breitholtz (V) and Ingemar Gunnarsson (GE).

Funded by the Swedish Energy Agency, Energiforsk - Swedish Energy Research Center and Göteborg Energi AB.

This project focused on developing the methodology for monitoring and evaluation of DFB-gasifiers. For this purpose, a new sampling system was successfully implemented at the GoBiGas gasifier. Measuring tar is both complex and time-consuming and therefore the method of monitoring the level of tar using the correlation with the methane concentration has been a crucial development, and the method was successfully implemented to control gas quality in the GoBiGas gasifier.

The sampling system developed in the current project has also made it possible to evaluate the performance of the gasifier and gas cleaning, and to analyze how the process can be optimized.

Report – Energiforsk 2018:466, ISBN 978-91-7673-466-7

## **BioProGReSs 2014–17**

Performed by Göteborg Energi (coordinator) in cooperation with Chalmers Technical University, TU in Berlin and Renewtec.

Funded by the European research program ERA NET/Bestf.

BioProGReSs is an acronym for Biomass Product Gas Reforming Solutions and in the project, advanced syngas cleaning based on chemical-looping reforming is designed and tested both at Chalmers and at GoBiGas. This multidisciplinary project involved partners from Sweden and Germany and it was coordinated by Gothenburg Energy with Chalmers University of Technology, Technische Universität Berlin and Renewtec AB as project partners. In addition, Wandschneider + Gutjahr and AMENKO were involved as subcontractors.

The main objectives were to develop, implement and demonstrate new innovative syngas cleaning methods in both pilot and industrial-scale gasification facilities, in order to reduce investment cost and operation costs. In addition, a novel online tar measurement technique was demonstrated and implemented in an *industrial environment* – the GoBiGas I plant – in order to monitor and control gas cleaning.

Report - published by Renewtec Report 007:2018, ISSN 2001-6255

### **Choice of suitable additives to bed-material 2014–17**

Performed by Pavleta Knutsson, Martin Seemann and Jelena Marinkovic at Chalmers University of Technology

Funded by Swedish Energy Agency/Energiforsk and Göteborg Energi AB.

Olivine,  $\text{FeMgSiO}_4$ , traditionally used as a catalytic bed material for tar cracking in biomass gasification. Different modifications of olivine have been shown to enhance its catalytic performance, such as heat pretreatment and additives in form of metallic compounds naturally existing in olivine and foreign to olivine compounds. The goal of this project was through a series of experimental campaigns on both laboratory and plant scale to point on the necessary additives and actions needed for achieving the maximum catalytic performance of olivine.

The experiments were performed at two different units – Chalmers 4 MW gasifier and the 20 MW GoBiGas plant. Bed materials were sampled and characterized on a compositional level, through total elemental analysis and on a structural level through SEM-EDS and XRD. The activity of the material was followed through gas analysis and tar measurements. The results show that addition of  $\text{K}_2\text{CO}_3$  to the process can provoke an immediate response and improve gas quality.

Report – Energiforsk 2017:400, ISBN978-91-7673-400-1

### **Char conversion indirect gasification in fluidized beds 2015–17**

Performed by Chalmers University of Technology David Pallarès, Robert Johansson, Louise Lundberg and Henrik Thunman and Anton Larsson Göteborg Energi AB.

Funded by the Swedish Energy Agency and Swedish Energy Research Center

The main objective was investigation of char conversion in indirect gasification processes with the goal to optimize the process for higher efficiency. The project involves both measurements in units of different scale, including GoBiGas, and development of models that can describe it in the different facilities.

Report – Energiforsk 2017:393, ISBN 978-91-7673-393-6

### **New instruments for online measurements of alkali and tars during gasification of biomass 2014–16**

Performed by Kent Davidsson (project leader), Mohit Puship SP/Rise and Dan Gall, Jan Pettersson University of Gothenburg.

Funded by Swedish Energy Agency/SGC and Göteborg Energi AB research foundation

New online instruments for alkali and particle measurements in product gas from gasification have been tested in GoBiGas during two measurements campaigns. The alkali instruments are a surface ionization detector (SID) and a detector that combines surface ionization and mass spectrometry (Alkali AMS). The particle instruments are a scanning mobility particle sizer (SMPS) and a dust monitor which measure particle distributions for sub-micron particles.

Report – Energiforsk 2016:286, ISBN 987-91-7673-286:1

### **Ash and bed material effects during dual bed gasification 2014–16**

Performed by and Kent Davidsson (project leader), Placid Techoffor and Björn Folkesson SP/Rise and Farzad Moradian, Anita Petersson and Tobias Richards Borås university

Funded by Energiforsk AB, Swedish Energy Agency and Göteborg Energi AB research foundation

Experiments in a bubbling fluidized lab reactor were performed with four types of fuel (forest residues, straw and two mixes of these) and three bed materials (silica sand, Olivine and bauxite). The release of ash-forming elements from the fuels and their binding tendency was examined.

It showed that olivine is a good bed-material when trying to avoid agglomeration.

Report – Energiforsk 2016:284, ISBN 987-91-7673-284-7

### **Online Measurement with FTIR adapted to gasification 2014–15**

Performed by Brackman Lund University and Davidsson and Pushp SP/Rise

Funded by Göteborg Energi AB research foundation

The aim was to design and implement a high-temperature cell together with an FTIR to make online measurements on produced syngas. The solution showed potential but further development is required to make the technology useful in practice.

Report – Göteborg Energi AB forskningsstiftelse projektnummer 14–5

## Appendix 3 – List of Key Personnel, from January 2011 until May 2018

### Project Phase (2011–2014)

Position	Name
Project Director (2011–2014)	Åsa Burman
Project Director (2014–2016)	Freddy Tengberg
Project Manager, EPCM & Deputy Project Director	Freddy Tengberg
Project Manager, Gasification	Malin Hedenskog
Project Manager, OSBL	Hanna Strand
Project Manager, OSBL	Johan Svalstedt
Project Manager, OSBL	Göran Sandberg
Project Manager, Feedstock Handling	Göran Sandberg
R&D Engineer	Ingemar Gunnarsson
Engineering Manager & Mechanical Engineer	Lars Gustafsson
Mechanical Engineer, EPCM	Henrik Larsson
Mechanical Engineer, Gasification	Torbjörn Spaak
Process Engineer, Process Safety Responsible & Commissioning Manager	Staffan Andersson
Process Engineer, EPCM	Åsa Marbe
Process Engineer, Gasification	Lars Andersson
Instrument Engineer, EPCM	Torben Granbom
Instrument Engineer, Gasification	Kenneth Thörnblom
Electrical Engineer & Maintenance Manager	Per Lindeberg
CSA Engineer	Gunnar Ekman
Procurement Manager	P-O Jonsson
Permissions Coordinator	Bengt Yngve
Health & Safety Engineer	Robert Grönlund
QA/QC Responsible	Malin Hedenskog
Financial Controller	Torbjörn Unger
Financial Controller	Johan Jacobsson
Financial Controller	Bo Freychuss
Financial Controller	Charlotte Ekberg

### Operational Phase (2015–2018)

Position	Name
Site Manager	Freddy Tengberg
Operations Manager	Hans Liljered
Operations Manager	Malin Hedenskog
Operations Manager	Joakim Bergfors
Technical Manager	Per Lindeberg
Process & Start-up Manager, Methanation	Staffan Andersson
Process & Start-up Manager, Gasification	Anton Larsson
Field & Start-up Technician, Gasification	Nicklas Wenström
R&D Engineer	Ingemar Gunnarsson
Operations Engineer	Hans Liljered
Operations Engineer	Fredrik Berggren
Plant Engineer	Emma Gustafsson
Process Engineer, Methanation	Anna-Karin Nilsson
Process Engineer, Gasification & OSBL	Mija Kaneroth
Process Engineer, Gasification & OSBL	Anna Hultén
Instrument Engineer	Torben Granbom
Automation Engineer	Kenneth Thörnblom
Maintenance Engineer	Joakim Bergfors
Laboratory Engineer	Emma Gustafsson
Laboratory Engineer	Elisabeth Öberg
Environmental Engineer	Helena Winsell



## Appendix 4 – Performance Parameters

Table A4.1: Performance parameters

Notation	Description	Equation
$\eta_{RG}$	Raw gas efficiency	$\eta_{RG} = \frac{E_{RG}}{E_f} [\%LHV_{daf}]$ (1)
$\eta_{CG}$	Cold gas efficiency	$\eta_{CG} = \frac{E_{CG}}{E_f} [\%LHV_{daf}]$ (2)
$\eta_{CH_4}$	Biomass to biomethane efficiency	$\eta_{bCH_4} = \frac{E_{CH_4}}{E_f} [\%LHV_{daf}]$ (3)
$\eta_{sect}$	Efficiency of gasification section	$\eta_{sect} = \frac{E_{CG}}{E_f + E_{RME} + El_{sect}} [\%E_{tot}]$ (4)
$\eta_{plant}$	Plant efficiency	$\eta_{plant} = \frac{E_{CH_4}}{E_f + E_{RME} + El_{tot}} [\%E_{tot}]$ (5)
$\eta_{P2G}$	Marginal efficiency of power to gas	$\eta_{P2G} = \frac{E_{CH_4}^* - E_{CH_4}}{El_{sect}} [MW_{bCH_4}/MW_{el}]$ (6)
$\mu_C$	Carbon efficiency	$\eta_{carbon} = \frac{\mu_C}{\mu_{C,theoretical}} [\%]$ (7)
$\eta_{Carbon}$	Theoretical carbon utilization*	$\mu_{C,theoretical} = (4 - 2(O/C)_{daf} + (H/C)_{daf}) / (4 - 2(O/C)_{CH_4} + (H/C)_{CH_4}) [\%]$ (8)

\*The theoretical value is estimated based on the composition of the methane and biomass respectively and a conversion with abundant access to H<sub>2</sub>O and no heat losses as further described by A. Larsson [32]. For the conversion of wood pellet into pure methane  $\mu_{C,theoretical} = 0.52$ . The rest of the carbon will form CO<sub>2</sub> together with the oxygen in the biomass. Only by adding hydrogen from an external source can carbon utilization be increased beyond this limit.

Table A4.2: Notations

Variable	Unit	Description
$E_{RG}$	MW	Chemically stored energy in the raw gas from the gasifier, LHV
$E_f$	MW	Chemically stored energy in the dry ash free fuel, LHV
$E_{CG}$	MW	Chemically stored energy in the cold gas, LHV
$E_{CH_4}$	MW	Chemically stored energy in the produced biomethane, LHV
$E_{RME}$	MW	Chemically stored energy in the RME, LHV
$El_{sect}$	MW	Electricity utilized in the gasification section
$El_{tot}$	MW	Electricity utilized in the plant
$E_{CH_4}^*$	MW	Chemically stored energy in the produced biomethane with electricity addition, LHV
$\mu_C$	-	Kg of C in biomethane per kg of C in the dry ash free fuel
$(O/C)_{daf}$	-	Mol O per mol C in the dry ash free fuel
$(H/C)_{daf}$	-	Mol H per mol C in the dry ash free fuel
$(O/C)_{CH_4}$	-	Mol O per mol C in methane
$(H/C)_{CH_4}$	-	Mol H per mol C in methane



## Appendix 5 – Gas Quality and Performance over Time

The longest coherent operational period with wood pellets was close to 1,750 hours and to illustrate the dynamics of the process, gas composition downstream the gasifier is presented as a function of time in Fig. A5.1. Besides a short disturbance in gasifier operation, gas composition downstream of the gasifier was very stable. Note also that there are a few sudden changes in the concentration of CO<sub>2</sub> as the purge gas was temporarily changed to N<sub>2</sub>.

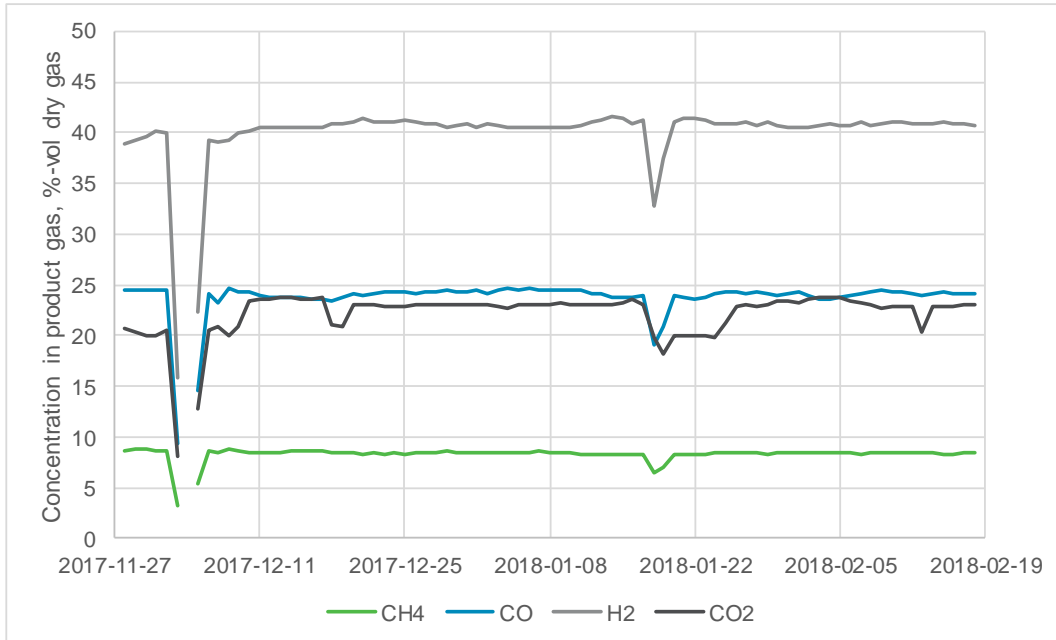

Figure A5.1: Concentrations of main gas components during continuous operation with wood pellets.

The composition of the gas downstream of the methanation process during the same period are presented in Fig. A5.2. Gas was delivered to the grid when the CH<sub>4</sub> concentration was above 94%, which it was during most of the period except for some temporary disturbances which can be seen as a drop in CH<sub>4</sub> and increase of CO<sub>2</sub>. Except for some unexpected variations in the dew point, stable and high gas quality could be maintained.

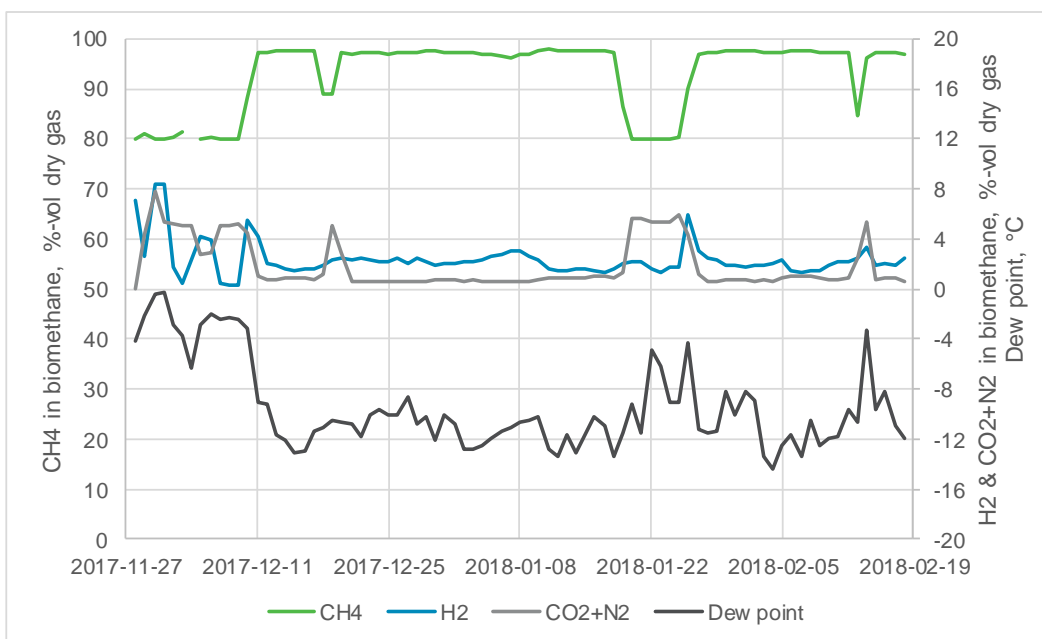

Figure A5.2: Composition of the produced biomethane during continuous operation with wood pellets.

The carbon conversion efficiency illustrated in Fig. A5.3 is about 0.3, which means that 30% of the carbon in the biomass is retained in the produced biomethane and 70% goes as CO<sub>2</sub>. This corresponds to a carbon conversion efficiency of 0.55–0.60, indicating that during operation about 40% of the carbon that could be converted to methane is instead converted to CO<sub>2</sub> in the combustion reactor to heat the process. By decreasing process heat demand, both carbon utilization and efficiency can be improved, described in more detail below. In summary, during the period investigated, about 48% of the carbon in the fuel is converted to CO<sub>2</sub> in the produced gas due to the oxygen content of the fuel. It is separated as pure CO<sub>2</sub> in a scrubber, while about 22% is converted to CO<sub>2</sub> in the flue gas and around 30% is retained in the biomethane.

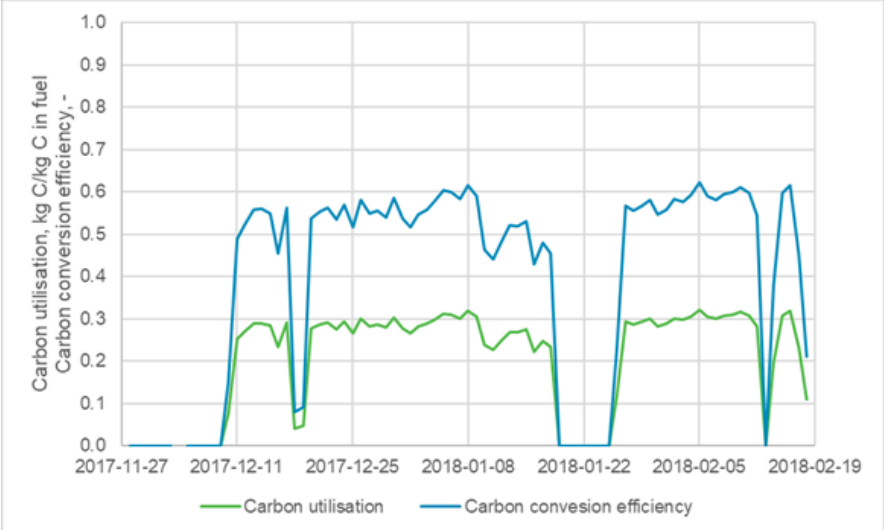

Figure A5.3: Carbon utilization and carbon efficiency during continuous operation with wood pellets.

The efficiency of the process during this period is illustrated in Fig. A5.4, which shows a cold gas efficiency of 65–70% and a biomethane efficiency of about 50–55%. Note that a significant amount of gas had to be recirculated to the post-combustion chamber to limit CO emissions as described in section 3.2, reducing efficiency significantly. The major part of the fluctuations in efficiency is also related to high variations in the amount of gas combusted in the post-combustion chamber, corresponding to around 10% of the gas production.

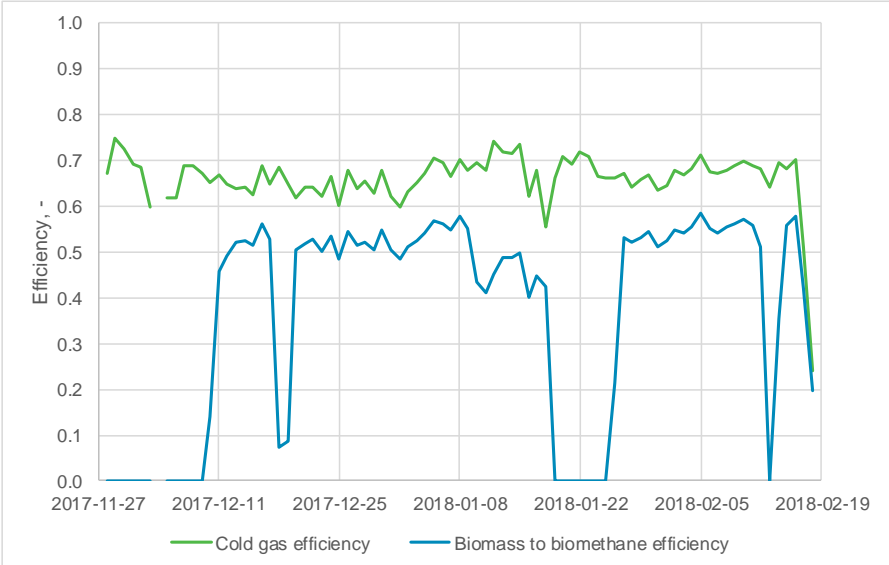

Figure A5.4: Efficiency of the Gasification section (Cold Gas) as well as for the whole process for conversion into biomethane during continuous operation with wood pellets.