

THESIS FOR THE DEGREE OF LICENTIATE OF ENGINEERING

Flexural Strengthening of Reinforced Concrete Beams Using Externally Bonded CFRP

An Innovative Method for the Application of Prestressed CFRP Laminates

JINCHENG YANG

Department of Architecture and Civil Engineering

Division of Structural Engineering

CHALMERS UNIVERSITY OF TECHNOLOGY

Gothenburg, Sweden 2019

*Flexural Strengthening of Reinforced Concrete Beams Using Externally Bonded CFRP
An Innovative Method for the Application of Prestressed CFRP Laminates*

JINCHENG YANG

© JINCHENG YANG, 2019.

Thesis for the Degree of Licentiate of Engineering

Department of Architecture and Civil Engineering
Division of Structural Engineering
Lightweight Structures
Chalmers University of Technology
SE-412 96 Gothenburg
Sweden
Telephone + 46 (0)31-772 1000

Cover:

The figure shows the innovative method facilitated by the developed prestressing tool for the application of prestressed CFRP laminates used as externally bonded reinforcement on reinforced concrete beams.

Chalmers Reproservice
Gothenburg, Sweden 2019

To Jiawen

Flexural Strengthening of Reinforced Concrete Beams Using Externally Bonded CFRP
An Innovative Method for the Application of Prestressed CFRP Laminates
JINCHENG YANG

Department of Architecture and Civil Engineering
Division of Structural Engineering
Lightweight Structures
Chalmers University of Technology

ABSTRACT

A large number of existing bridges in European countries are structurally deficient and functionally obsolete due to the deterioration of aging bridges and the lack of structural and geometric capacity to accommodate the increasing traffic volume and load levels. To meet the demand for holistic and effective strengthening techniques the SUREBRIDGE solution is proposed for the refurbishment of concrete bridges, which includes the technique of using prestressed carbon fiber reinforced polymer (CFRP) laminate as externally bonded reinforcement for flexural strengthening.

This thesis studied an innovative method, adopted in the SUREBRIDGE solution, for the application of prestressed CFRP laminates, which aimed to realize the self-anchorage of the prestressed laminates on RC members without the need for conventional mechanical anchorage.

The method, named the stepwise prestressing method, was implemented in the laboratory to apply a prestressed CFRP laminate to an RC beam for flexural strengthening. The implementation showed that the CFRP laminate prestressed with a force up to 100 kN was self-anchored to the beam without installing anchors at the laminate ends. Finite element (FE) analyses were performed to further study the interfacial stresses in the CFRP-concrete adhesive joint. The FE results revealed that, owing to the use of the stepwise prestressing method, the interfacial shear stresses were significantly reduced, which yielded a sufficient margin for the safe self-anchorage of the prestressed laminate.

The experiment program of four-point bending tests was carried out to investigate the effectiveness of the method for the flexural strengthening of the RC beam with the self-anchored prestressed laminate in both serviceability limit state (SLS) and ultimate limit state (ULS). The performance of this prestressed beam was evaluated and further compared with an un-strengthened beam and a beam strengthened with an unstressed CFRP laminate. The comparison of experimental results showed that, even though no end anchorage was used, the self-anchored prestressed laminate effectively improved the performance of the strengthened beam regarding bending stiffness after cracking stage, widths of crack openings, ultimate capacity, and the utilization ratio of CFRP laminates at failure.

Nonlinear finite element (NLFE) analyses of the beams subjected to the bending tests were conducted to perform parametric studies on prestressing levels and the elastic modulus of CFRP laminates. The parametric studies delivered optimization recommendations for the application of prestressed laminates with a consideration of bending response, failure model, ultimate capacity, and ductility of strengthened beams.

Keywords: carbon fiber reinforced polymer (CFRP), reinforced concrete, flexural strengthening, stepwise prestressing, externally bonded, interfacial stress, debonding, anchorage, finite element modeling, smeared length, mesh sensitivity, optimization

PREFACE

The work presented in this thesis was conducted between April 2016 and February 2019 at Chalmers University of Technology. The research has been carried out within the framework of project SUREBRIDGE funded by partners of the ERA-NET plus Infravation program.

I would like to thank my supervisor Associate Professor Reza Haghani for his precious guidance and encouragement on my way to the licentiate seminar. I have been inspired by him and got interested in fiber reinforced polymer (FRP) materials since my work of master thesis under his supervision in 2014. Sincere gratitude to my examiner Associate Professor Mohammad Al-Emrani for his continuous support and constructive advice in my research work, and surely the wisdom and great sense of humor in life. I would also like to deliver my appreciation to my co-supervisor Adjunct Professor Morgan Johansson for his inspiring ideas and profound insight into structural concrete. Thanks to my colleagues at the Division of Structural Engineering who have been creating such a friendly and helpful working environment. Special thanks to my colleagues and friends Rasoul Atashipour, Erik Olsson, and Alexandre Mathern.

Thanks to Jiawen for all your love. I was definitely blessed with the chance to meet you in Gothenburg at the beginning of my Ph.D. study. Without your company and support, I cannot make it.

Jincheng Yang

Gothenburg, Chinese New Year's Eve 2019

LIST OF PUBLICATION

This thesis is based on the work contained in the following papers:

Paper I

Yang J., Haghani R., and Al-Emrani M. (2018). Innovative prestressing method for externally bonded CFRP laminates without mechanical anchorage. Submitted to *Construction & Building Materials*.

Paper II

Yang J., Haghani R., Al-Emrani M., and Johansson M. (2018). Innovative flexural strengthening of RC beams using self-anchored prestressed CFRP laminates: experimental and numerical investigations. To be submitted.

AUTHOR'S CONTRIBUTIONS TO JOINTLY PUBLISHED PAPERS

The contribution of the author of this licentiate thesis to the appended papers is described here.

- I. Responsible for the major part of the planning and writing of the paper. The author performed the literature review, helped with the execution of the experiment test, conducted the numerical analyses, and was responsible for the results, discussions, and conclusions;
- II. Responsible for the major part of the planning and writing of the paper. The author performed the literature review, helped with the execution of the experiment test, conducted the numerical analyses, and was responsible for the results, discussions, and conclusions.

ADDITIONAL PUBLICATIONS BY THE AUTHOR

Conference Paper I

Atashipour R., Yang J., and Haghani R. (2018). Mathematical analysis of an innovative method for strengthening concrete beams using pre-stressed FRP laminates. *Proceedings of the 9th IABMAS conference*, Melbourne, 09-13 July 2018.

Conference Paper II

Yang J., Haghani R., and Al-Emrani M. (2018). Flexural FRP Strengthening of Concrete Bridges Using an Innovative Concept. *Proceedings of the 9th IABMAS conference*, Melbourne, 09-13 July 2018.

Conference Paper III

Yang J., Haghani R., and Al-Emrani M. (2017). Flexural strengthening of reinforced concrete beams using externally bonded FRP laminates prestressed with a new method. *Proceedings of the 4th SMAR conference*, Zurich, 13-15 September 2017.

Conference Paper IV

Yang J., Haghani R., Valvo P, Ricci F., and Veltkamp M. (2017). A New Concept for Sustainable Refurbishment of Existing Bridges Using FRP Materials. *Proceedings of the 4th SMAR conference*, Zurich, 13-15 September 2017.

Report

Haghani R., Yang J., Pasquale A., Ricci F., and Valvo P. (2017). *Deliverable 2.1—Refurbishment of existing concrete and steel-concrete bridge structures*. Retrieved from <http://www.surebridge.eu/>

Conference Paper V

Yang J., and Haghani R. (2016). Application of FRP materials for construction of culvert bridges. *Proceedings of the 19th IABSE Congress*, Stockholm, 21-13 September 2016.

CONTENT

ABSTRACT	I
PREFACE	III
LIST OF PUBLICATION	V
CONTENT	IX
1. Introduction	1
1.1 Background	1
1.2 Aim and objectives	3
1.3 Approaches	3
1.4 Scope and limitations	4
1.5 Outline	4
2 An innovative method for the application of prestressed CFRP laminates	5
2.1 Introduction	5
2.2 Stepwise prestressing method.....	7
2.3 The principle of the stepwise prestressing method.....	8
2.4 Prestressing tool	8
2.5 Operation of the prestressing system.....	10
3 Experimental program	11
4 Numerical analysis	13
4.1 Nonlinear modeling of concrete	13
4.2 Mesh sensitivity analysis.....	15
4.3 Bond behavior between steel reinforcement and concrete	16
5 Experimental and numerical results.....	18
5.1 Applying prestressed CFRP laminates to RC beams.....	18
5.2 Flexural performance of strengthened beams.....	19
5.3 Optimization of the prestressed CFRP strengthening.....	21
6 Conclusions and future study.....	23
7 References	25

APPENDED PAPERS

Paper I	I-0
Paper II	II-0

1. Introduction

1.1 Background

In the years 1945-1970, a large number of bridges were constructed due to the rebuilding and the need for new road and railway networks after World War II. In Belgium, for instance, with a relatively small area of 30 500 km², 210 bridges were built annually in the seventies (Radomski, 2002). Nowadays, bridge owners and traffic authorities in European countries are dealing with a massive amount of old bridges which are structurally deficient and functionally obsolete. The demography of bridges in 17 European countries, as shown in Figure 1.1, reveals that 67% of railway bridges are more than 50 years old and 35% are older than 100 years (Bien et al. 2007). In Sweden, the Swedish Traffic Administration (TRV) manages over 25 000 bridges; about 75% of railway bridges and 36% of road bridges are older than 50 years (PANTURA, 2011). The aging bridges are structurally deficient due to deterioration and thus in need of maintenance and repair. For instance, it has been found that in France about 50% of more than 20 000 bridges located along 30 000 km of national roads are required to be repaired. In Poland, about 50% of more than 29 000 highway bridges are older than 50 years and approximately 20% of the bridges are in poor technical conditions (Radomski, 2002).

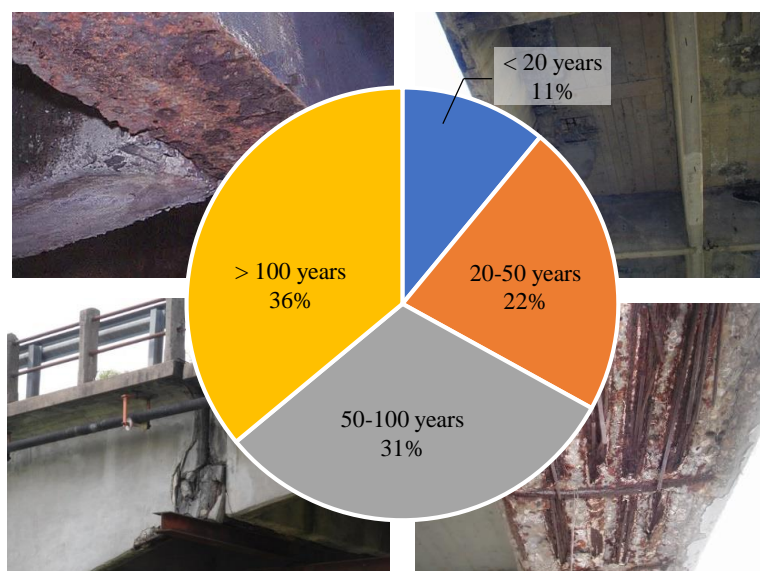

Figure 1.1 General age profile of railway bridges in 17 European countries according to the report of the Sustainable Bridge project (Bien et al. 2007)

In addition to the structural deficiency of bridges, there is a need for European bridges to carry increased loads and allow higher speeds and capacities for passenger and freight traffic. Therefore, bridges are becoming functionally obsolete with respect to current or predicted traffic situations. A statistic study of bridges two decades ago has already shown that the needs resulting from the functional obsolescence are often more urgent than those due to structural deficiency (Radomski, 2002). According to the ECTP Strategic Research Agenda (ECTP, 2005), road transport is expected to double within the next 15-35 years, and bridges are among the main bottlenecks in road networks. Therefore, the refurbishment of the functionally obsolete bridges, for instance, may include not only upgrading the load-bearing capacity but also geometric modernization or enlargement, e.g. widening of bridge decks. The report of the European project PANTURA (PANTURA, 2011) has pointed out that two major areas of problems in existing bridges are (a) the aging and lack of load-bearing capacity of decks and (b) the need for wider decks for higher traffic demands.

Although replacement of the deficient bridge is a regular alternative to the refurbishment, the replacement option is usually discouraged by the negative impact on the traffic flow and the environment nearby, especially in densely populated areas. The demolition and reconstruction processes involved with the replacement lead to substantial user cost and social cost due to, e.g., traffic disruption and closure, traffic congestion and delay, noise, vibration, and dust in the construction site. The replacement also prevents further utilizing the residual strength of the deficient structures in a sustainable way. Considering the growing public awareness of environmental issues and sustainable utilization of resources, the disadvantages of the replacement option render the refurbishment of existing structure more competitive. Traffic authorities have been putting strong demands for better refurbishment techniques to strengthen and modernize the functionally obsolete bridges. The study in the Sustainable Bridge project (Bien et al. 2007) has stated that bridge management authorities place a high priority on the research field of developing non-disruptive refurbishment techniques for bridge strengthening and repair. Considering that the concrete bridges account for 60-70% of the total number of bridges in Europe, the refurbishment of concrete bridges plays a predominant role in bridge engineering (Radomski, 2002). As the critical component of a bridge structure, concrete decks are highlighted in statistics (PANTURA, 2011), which has revealed that approximately 70% of the degradations in existing concrete and concrete-steel bridges are related to the concrete decks, e.g. the aging of the concrete deck and the loss of load-bearing capacity due to the corrosion of steel reinforcement.

To deal with the functionally obsolete problems of bridges and meet the demands made by bridge owners, a refurbishment solution is proposed in a EU funded research project named SUREBRIDGE, which aims to provide a holistic and sustainable refurbishment approach using fiber reinforced polymer (FRP) to upgrade the load bearing capacity and enlarge the geometry of concrete bridge superstructures in an effective and efficient way giving consideration to minimized disturbance to users and society (Yang et al. 2018). The proposed SUREBRIDGE refurbishment solution, in brief, consists of (a) installing a prefabricated lightweight glass-fiber reinforced polymer (GFRP) deck on the top of an existing concrete deck to establish a hybrid system and (b) strengthening with prestressed carbon fiber reinforced polymer (CFRP) laminates used as externally bonded reinforcement (EBR) on the bottom surface of the deck or main girders. The schematic concept of the SUREBRIDGE solution is illustrated in Figure 1.2.

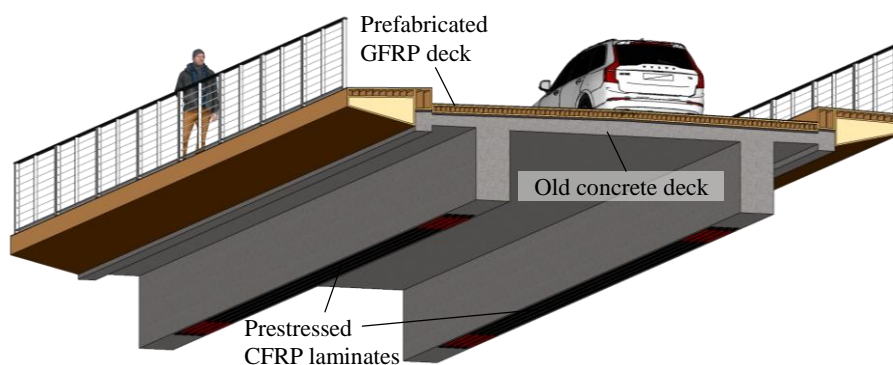

Figure 1.2 Applying the SUREBRIDGE refurbishment solution to a concrete bridge superstructure—install a prefabricated GFRP deck on the top of the old concrete deck and bond prestressed CFRP laminates on the bottom surface of main girders

The major innovations of the SUREBRIDGE solution are characterized by the prefabricated GFRP deck and the method for the application of the prestressed CFRP laminates in order to eliminate the need for conventional anchorage at the ends of laminates. The benefits of installing the GFRP deck on the existing concrete deck include:

- Provide the opportunity to easily widen the old concrete deck. The GFRP deck is prefabricated in workshops with a tailored geometry. Thus, it can easily satisfy the demand for a wider deck to accommodate increased traffic volume;
- Enhance bending stiffness and load-bearing capacity. Installing the GFRP deck achieves the new composite deck with increased cross-sectional area and the moment of inertia. The GFRP deck also helps release stresses from the concrete deck, avoid concrete crushing failure in the deteriorated concrete deck, and thus increase the structural capacity.
- Create synergies together with the bonded prestressed CFRP laminates to further upgrade the load-bearing capacity. The installed GFRP deck allows a higher prestressing level of the laminates and thus develop the potential for higher capacity to resist heavily loaded conditions;
- Save the construction time and minimize the traffic closure due to the lightweight and prefabricated features of the GFRP deck;
- Protect the old concrete deck from weather and environmental effects in the service life, e.g., solar radiation, rainfalls, freeze-thaw cycles and using de-icing salt.

Using CFRP laminate as EBR has become a widely accepted technique to enhance the flexural capacity of structural members since its first application to a field project at Lucerne, Switzerland in the year of 1991 (Meier, 1995). Prestressing the laminates prior to bonding can further improve the flexural performance in serviceability limit state (SLS) and the ultimate limit state (ULS) (Yang et al. 2017). In the SUREBRIDGE solution, the CFRP laminates are prestressed and applied with an innovative method, which aims to realize the self-anchorage of the prestressed laminates without the need for conventional end anchorage.

Taking advantage of the superior tensile strength of the CFRP laminates and the prefabricated GFRP deck, the SUREBRIDGE solution aims to deliver sufficiently improved performance level to the functionally obsolete concrete bridges beyond what conventional strengthening methods can offer regarding capacity upgrading and geometric modernization.

1.2 Aim and objectives

This thesis mainly focuses on the innovative method for the application of prestressed CFRP laminates proposed in the SUREBRIDGE refurbishment solution. The aim of this work is to investigate the effectiveness of the method with respect to the self-anchorage of the prestressed laminates and the flexural strengthening of reinforced concrete (RC) beams. To obtain the aim, the identified objectives include:

1. To study the application of the prestressed CFRP laminates to RC beams based on the proposed method and further analyze the stress states of the applied CFRP laminates in different phases of the application;
2. To investigate the effect of the self-anchored prestressed laminates on the flexural performance of strengthened RC beams in SLS and ULS;
3. To deliver optimization recommendations for the application of the prestressed CFRP laminates.

1.3 Approaches

The research work in this thesis is carried out in experimental and numerical approaches. The objectives are treated in two papers as follows:

Paper I presents the application of a prestressed laminate to an RC beam in the laboratory using the proposed method. Finite element (FE) analyses are performed to investigate the stress states in the

prestressed CFRP laminate and the CFRP-concrete bond line in different application phases. Based on the FE analysis, a comparison of the stress states between the proposed method and the conventional prestressing approach is conducted to identify the safety margin of the self-anchored laminate owing to the implementation of the proposed method.

Paper II investigates the effectiveness of the method regarding the flexural strengthening of RC beams with the self-anchored prestressed laminates. The experimental program of four-point bending tests is carried out to evaluate the behavior of strengthened beams in SLS and ULS. Numerical studies based on nonlinear finite element (NLFE) analyses are conducted to perform parametric studies and thus provide optimization recommendations for the application of the prestressed CFRP laminates.

1.4 Scope and limitations

The NLFE analyses performed in Paper II assume a ‘perfect bond’ between steel reinforcement bars and surrounding concrete, which means that no relative slip exists at the bond interface. Although the current NLFE models are able to deliver reliable load-deflection relations, the models cannot provide the accurate prediction of crack patterns and crack widths in the RC beams. This is further discussed in Section 4.3.

1.5 Outline

The outline of this thesis is listed as follows:

Chapter 1 introduces the background, motivation, and innovations of the SUREBRIDGE refurbishment solution, and then highlights the innovative method for the application of prestressed CFRP laminate as the topic of the thesis;

Chapter 2 introduces and elaborates a stepwise prestressing method and a developed prestressing tool, which comprise the core techniques for the application of prestressed laminates;

Chapter 3 and Chapter 4 introduce the experimental program and the strategies of numerical studies;

Chapter 5 summarizes the experimental and numerical results with regard to the stress states of the prestressed CFRP laminates and CFRP-concrete adhesive joint during the application period and the flexural performance of the strengthened beams during testing;

Chapter 6 draws the conclusions based on the experimental and numerical studies of the method for the application of prestressed CFRP laminates. Recommendations for future study are also put forward.

2 An innovative method for the application of prestressed CFRP laminates

As proposed in the SUREBRIDGE solution, the innovation method for the application of prestressed CFRP laminate is discussed in this section with emphasis on a prestressing method plus a special prestressing tool adopted as core techniques. The requirement of end anchorage in the conventional application of prestressed CFRP laminates is first explained. The anchor-related problems are summarized as the motivation for developing new methods to eliminate the need for end anchorage. The innovative prestressing method and the prestressing tool (Haghani et al. 2015) are highlighted and discussed with respect to principles and operational procedures. Adopting the prestressing method in the SUREBRIDGE solution aims to realize the self-anchorage of the prestressed CFRP laminates to RC members without installing end anchors and thus avoid the anchor-related problems.

2.1 Introduction

Using CFRP laminates as EBR has been a widely accepted technique to increase the flexural capacity of deficient structures made of concrete, steel or timber materials (Meier 1995; Bakis et al. 2002; Haghani et al. 2009; Kliger et al. 2016). For the first time in the world, the CFRP laminates were applied to the Ibach bridge at Lucerne, Switzerland in 1991 (Meier, 1995). The simplicity and effectiveness of the CFRP laminate bonding technique had shown many advantages over other strengthening methods, e.g. steel plate bonding, applied to concrete structures. To further increase the effectiveness of applying the externally bonded CFRP laminates, the concept of using prestressed CFRP laminates instead of the unstressed ones was proposed (Triantafillou et al. 1992). Using the prestressed CFRP laminates can further improve the flexural performance of strengthened RC members by providing, e.g., higher bending stiffness and smaller crack openings in the SLS and improved flexural capacity in the ULS (El-Hacha et al. 2001; Aslam et al. 2015). However, the problem of using the prestressed laminates has been the significant concentration of shear stresses at the ends of the bonded laminates (Figure 2.1a), which might lead to a premature debonding failure of the strengthening scheme at these locations. The analysis of interfacial shear stress in beams strengthened with bonded prestressed laminate (Al-Emrani & Kliger, 2006) has shown that the peak shear stress at the ends of bonded laminate could reach as high as 80 MPa given that a constant prestressing force of 100 kN was employed. When a prestressed CFRP laminate is applied to concrete structures, the peak shear stresses at the bonded laminate ends might lead to the debonding of the laminate from the concrete surface even at very low prestressing levels, e.g. 5% of the laminate tensile strength (El-Hacha et al. 2001).

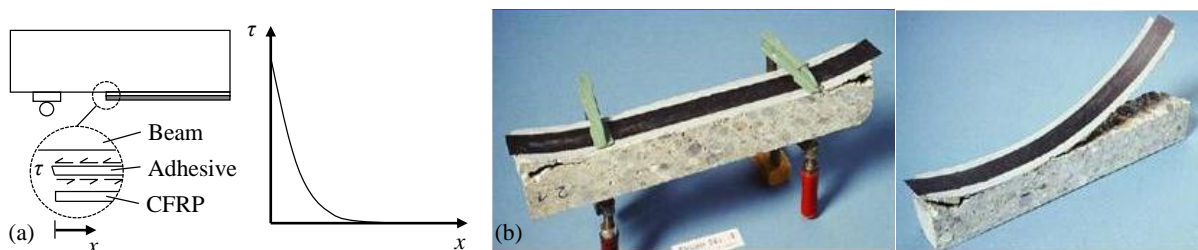

Figure 2.1 (a) Concentration of shear stresses at the ends of a prestressed CFRP laminate bonded to a beam; (b) Debonding of a prestressed CFRP laminate from a concrete substrate (Brunner & Schnueriger, 2005)

To prevent the premature debonding and guarantee full utilization of the prestressed CFRP laminates in the service life, a proper anchorage solution is required at the ends of the externally bonded laminates, named as end anchorage. In the absence of the end anchorage, the prestressed laminates may debond immediately after releasing the prestressing force, see the example shown in Figure 2.1b (Brunner & Schnueriger, 2005). Among the conventional anchorage solutions, mechanical anchors consisting of

metallic plates and bolts are the most common and effective type to keep the prestressed laminates in place and guarantee the force transferring between the concrete member and the bonded CFRP laminate. Figure 2.2 shows mechanical anchors clamping the prestressed CFRP laminate on the bottom of a concrete slab. However, mechanical anchors have several shortcomings, including:

- labor-intensive installation process involved with cutting and drilling concrete to insert steel plates and bolts;
- vulnerability to the galvanic corrosion of the metallic components;
- restrictions in inspection due to the lack of access;
- the dependency of anchorage performance on the quality of the adhesive within the anchor plate and thus uncertain long-term performance;
- sensitivity to workmanship;
- aesthetic aspects;
- vandalism issues.

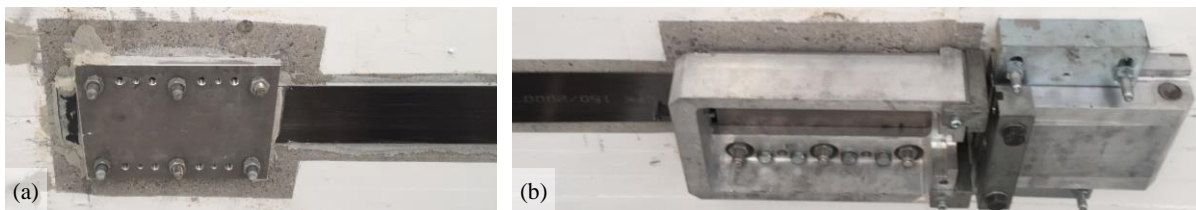

Figure 2.2 An example of commonly used mechanical anchors installed at the end of a prestressed CFRP laminate: (a) anchor on the passive end to fix the laminate during prestressing; (b) anchor on the active end where the laminate is pulled, e.g., by a hydraulic jack

Researchers have studied non-metallic anchors as an alternative to the metallic ones (Kim et al. 2008a, 2008b). Although the non-metallic alternatives can prevent some of the inherent shortcomings of the metallic anchors, they cannot deliver comparative anchorage capacity as the metallic ones (Kalfat et al. 2013). More existing anchorage solutions for externally bonded laminates can be found in reviews by Grelle and Sneed (2013) and Kalfat et al. (2013).

To eliminate the anchor-related issues, researches have proposed new anchorage or prestressing methods for the application of prestressed CFRP laminates, which allow for the self-anchorage of the prestressed laminate without the need for conventional end anchorage, e.g. the mechanical anchors. The proposed methods usually attempt to reduce the peak interfacial stresses occurring at the end of bonded CFRP laminate and rely on the bond strength between the laminate and the strengthened member to transfer the reduced interfacial stresses. Consequently, the need for installing permanent end anchors can be eliminated. Stöcklin and Meier (2001) proposed a gradient anchorage method to self-anchor prestressed laminates. The scheme of the gradient anchorage method is shown in Figure 2.3a (Kotynia et al. 2011). The gradient anchorage is realized by gradually releasing the prestressing force over a certain length at the end of the laminate. This length, named anchorage length, is divided into multiple segments over which the force-releasing takes place. In each step, a computer-controlled prestressing and curing system (Figure 2.3b) is used to partially released the tension force and cure the adhesive in the corresponding segment at an elevated temperature (Czaderski et al. 2012). This prestressing and curing process continues until the complete release of the prestressing force at the ends of the laminate. As a result, the prestressing level (i.e. axial tensile stress) in the laminate exhibits a gradually decreasing profile towards the laminate ends. The gradient anchorage method was applied to a field project in Poland for the first time in 2014 (Kotynia et al. 2015). However, the computer-controlled system involved with the force releasing and the adhesive curing at elevated temperature adds the complexity to the method. The multiple-step procedure of the prestressing and curing also requires certain operational time.

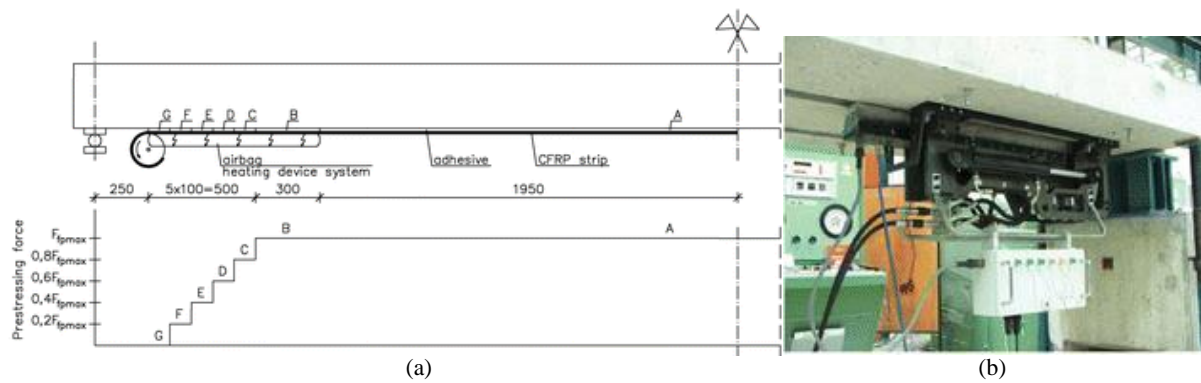

Figure 2.3 Gradient anchorage method for the application of prestressed CFRP laminate (Kotynia et al. 2011): (a) scheme of the gradient anchorage method; (b) prestressing system

2.2 Stepwise prestressing method

As another approach to eliminating the need for end anchors, Haghani et al. (2015) proposed a stepwise prestressing method to realize the self-anchorage of prestressed CFRP laminates with a simple prestressing process. The development of this method started in 2009 at Chalmers University of Technology in collaboration with the Swedish Transport Administration (TRV).



Figure 2.4 Field applications of the stepwise prestressing method (Haghani and Al-Emrani 2016): (a) concrete bridge over Nossan river in Sweden strengthened with one CFRP laminate on each girder prestressed with a force up to 100 kN; (b) concrete bridge located in Kiruna, Sweden strengthened with three prestressed CFRP laminates on one of the girders with a prestressing force of 110 kN per laminate; (c) strengthening of concrete wall segments in a hotel building in Umeå, Sweden using four prestressed CFRP laminates; (d) strengthening of an archive building in Arboga, Sweden with pre-stressed CFRP laminates

Different from the gradient anchorage method (Stöcklin and Meier 2001) that releases the prestressing force in multiple steps over the anchorage length, the stepwise prestressing method is able to create the gradually decreasing profile of the prestressing force towards the laminate ends in only one go (of pre-tension) (Yang et al. 2017). The pre-tension process is accomplished by using a special mechanical tool (named the prestressing tool). Facilitated by the prestressing tools, the stepwise prestressing method has been applied to several projects in Sweden (Haghani and Al-Emrani 2016). The first field demonstration of this method was carried out in collaboration with TRV in 2011, see Figure 2.4a. Two CFRP laminates with the cross-section of $80 \times 1.4 \text{ mm}^2$ were prestressed with a force up to 100 kN and bonded to the

girders. Other applications to projects performed in bridge, hotel and archive building are demonstrated in Figure 2.4.

2.3 The principle of the stepwise prestressing method

The stepwise prestressing method takes an innovative approach to apply prestressed laminates in order to eliminate the need for conventional end anchorage. The comparison between the stepwise prestressing method and the conventional prestressing approach is illustrated in Figure 2.5. In the conventional prestressing process, the laminate is clamped at two ends and then pulled by a hydraulic jack to create a constant axial tensile force P_0 over the full length of the laminate. Structural adhesive is applied and cured to bond the prestressed laminate with the strengthened member, e.g. the concrete beam in Figure 2.5. After removing the hydraulic jack, the high concentration of interfacial stresses will occur in the end region of the bonded laminate, over which the axial force in the laminate decreases to zero towards the laminate end and the peak interfacial shear stresses reach significantly high magnitudes τ_{max} , see Figure 2.5a. The short length (e.g. 50~100 mm) of the stress concentration area is denoted as $L_{0.conventional}$. In such a stress concentration area, the appropriate anchorage solution, as introduced in the previous Section 2.1, becomes critical to prevent the premature separation of the laminate from the concrete beam. Different from the conventional approach, the stepwise prestressing method applies the CFRP laminate with the aid of a special prestressing tool. In the prestressing phase, the prestressing tools hold each end of the laminate over an extended length (e.g. 1250 mm), see Figure 2.5b. The length, denoted as $L_{0.stepwise}$, is much longer than the $L_{0.conventional}$ of the conventional approach. Over the length $L_{0.stepwise}$, the prestressing level (i.e. the magnitude of the axial force) in the laminate can be manipulated by the prestressing tool in order to achieve a stepwise decreasing profile towards the laminate end. After removing the prestressing tool, the profile of the axial force in the bonded laminate exhibits a smaller gradient over $L_{0.stepwise}$ compared to the dramatic decrease over $L_{0.conventional}$. Considering that the gradient of the axial force is proportional to the magnitude of the interfacial stresses (Al-Emrani and Kligler 2006; Haghani et al. 2009), the peak values of the interfacial stresses can be greatly reduced by using the stepwise prestressing method, see Figure 2.5b. As a result, the strengths of the CFRP-concrete adhesive joint and the concrete substrate become sufficient to resist the reduced interfacial stresses. It also means that the bonded prestressed CFRP laminate can be self-anchored to the concrete beam without installing permanent end anchors.

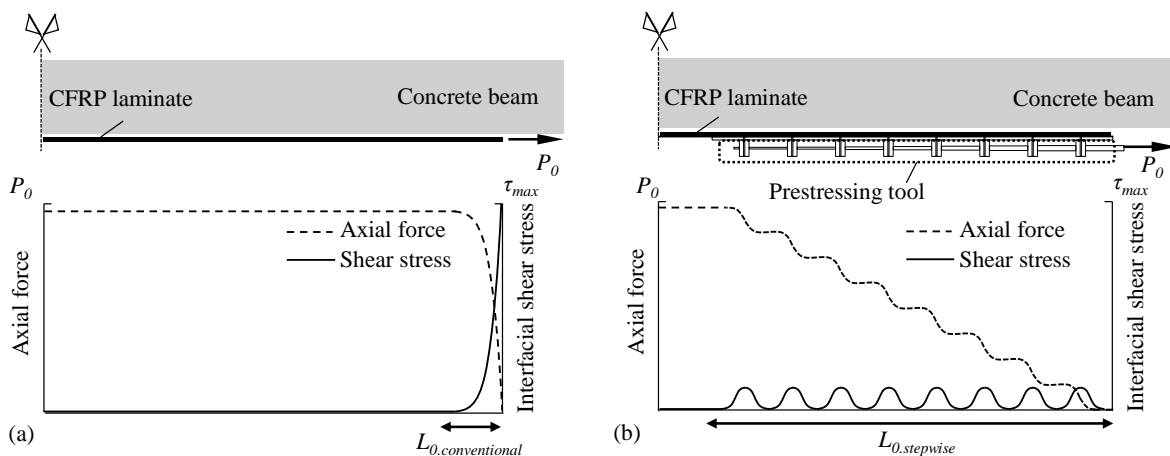

Figure 2.5 Comparison between (a) the conventional prestressing method and (b) the innovative stepwise prestressing method with regard to the axial force in the bonded prestressed CFRP laminate and the interfacial shear stress in the adhesive joint.

2.4 Prestressing tool

As the essential device developed for the prestressing method, the mechanical prestressing tool performs the function of creating a stepwise decreasing profile of the prestressing force towards the laminate ends over a predefined length L_0 . The length L_0 becomes the anchorage length of the bonded laminate after removing the prestressing tool (or system). The concept of the prestressing tool is illustrated in Figure

2.6. The tool is represented by a series of nodes interconnected with springs of different stiffness constants K_i ($i = 1, 2, \dots, n - 1$). A connection plate is used as a medium to facilitate the connection between the tool and the CFRP laminate, which is realized by the bolted connection for the node-to-connection plate and the adhesive bond for the connection plate-to-CFRP laminate. The connection plate not only facilitates the laminate-to-tab connection but also helps to avoid stress concentration in the distribution of the point load from each tab to the CFRP laminate due to the shear lag effect illustrated in Figure 2.6. When the total prestressing force P_0 is applied to the tool at the first node close to the hydraulic jack, the prestressing force P_0 transmits through the springs and nodes to laminate. The stiffnesses of springs K_i are designed in such a way that the force P_0 can be divided into n portions. Each portioned force $\Delta P = P_0/n$ is delivered from the corresponding node through the connection plate to the laminate, see Figure 2.6. Consequently, the axial tensile force in the laminate is built up in a manner illustrated in Figure 2.7, which exhibits a stepwisely varying profile over the anchorage length during prestressing without considering the shear lag effect. Since the magnitude of the interfacial shear stress is simply proportional to the gradient of the axial force in the laminate, the number of steps n and the distance of the intervals l_0 can be adjusted to control the peak shear stresses.

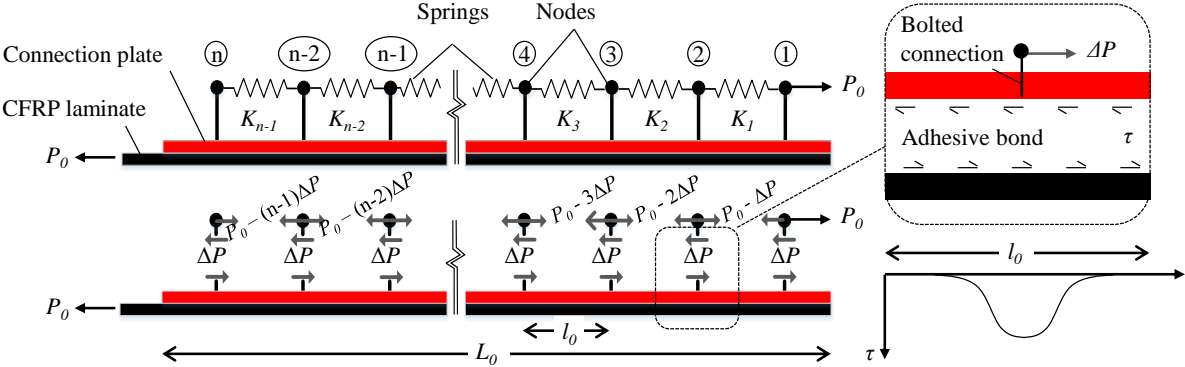

Figure 2.6 The schematic concept of the developed prestressing tool, which divides the total prestressing force P_0 into n portions and delivers the portioned point loads ΔP to the CFRP laminate over the anchorage length L_0

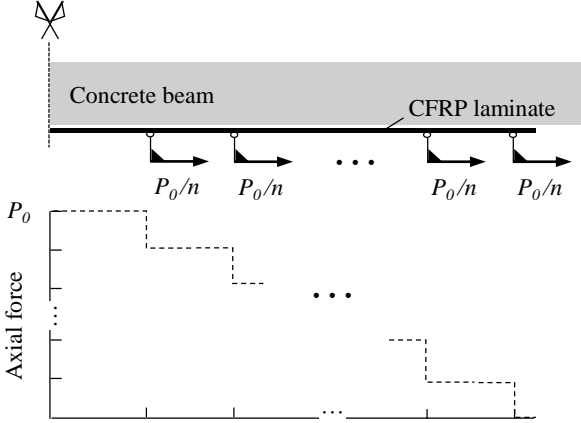

Figure 2.7 The profile of the axial force created in the CFRP laminate with the aided of the prestressing tool in the prestressing phase

The prestressing tool is made with aluminum tabs as the nodes and steel bars as the springs, see Figure 2.8a. The cross-sections of steel bars are designed with different diameters to provide varying stiffnesses. The connection plate, made of glass fiber reinforced polymer (GFRP), is 10-mm-thick with the same width as the CFRP laminate and a length equal to the designed anchorage length L_0 . As the connection medium between the laminate and the tool, the GFRP plate is first bonded to CFRP laminate at the workshop using an epoxy adhesive. Then, two high strength bolts (M6) are used at each tab to

connect the GFRP plate with the prestressing tool. The bolted connection enables the easy installation and demounting of the tool. To realize the bolted connection, the GFRP plate is equipped with embedded cap nuts at identical intervals that are equal to the spacing of tabs.

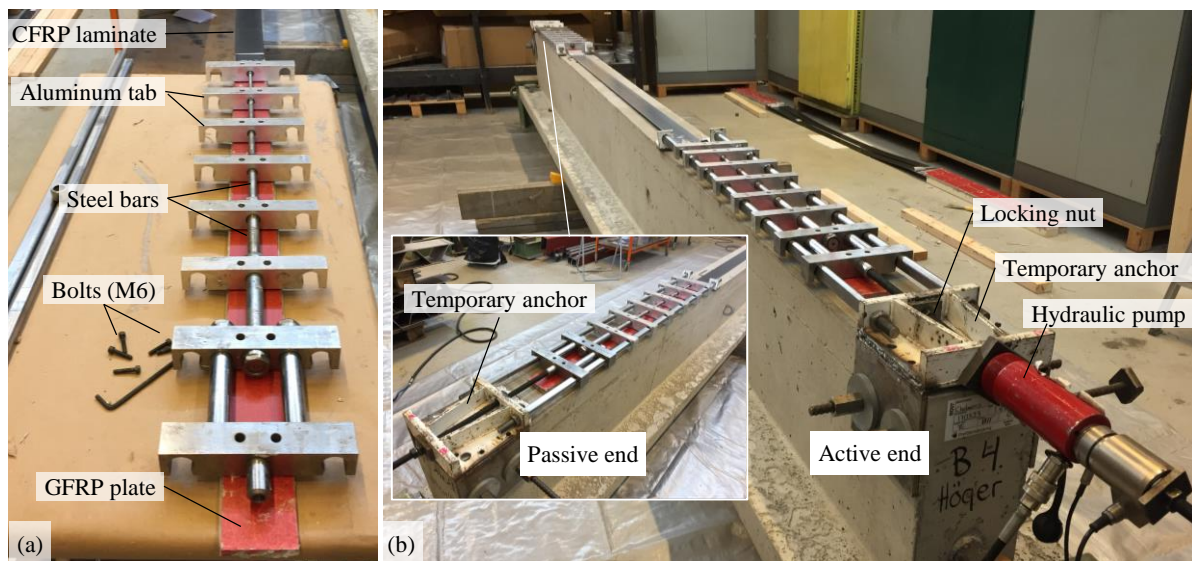

Figure 2.8 (a) Connect the prestressing tool to the CFRP laminate via the GFRP plate serving as a connection medium. The GFRP plate is bonded with the CFRP laminate and pre-embedded with cap nuts to allow the bolted connection with the prestressing tool; (b) Install the prestressing tools (attached with CFRP laminate) to the temporary anchors on the passive and active ends

2.5 Operation of the prestressing system

Based on the stepwise prestressing method, the application of a prestressed CFRP laminate to an RC beam includes the following steps in general:

1. Prepare the concrete surface in advance for the bond with the prestressed CFRP laminate;
2. Prepare the CFRP laminate with the designed length, and bond a GFRP plate with designed anchorage length at each end of the laminate;
3. Connect the prestressing tool to the GFRP plate with two bolts at each tab, see Figure 2.8a;
4. Apply epoxy adhesive on the surfaces of the concrete and the CFRP laminate;
5. Assemble the prestressing tools (attached with the CFRP laminate) to temporary anchors installed at each end of the beam, see Figure 2.8b;
6. On the passive end, fasten the prestressing tool to the temporary anchor; on the active end, pump the hydraulic jack connected to the prestressing tool till the tension force reaches the designed value, see Figure 2.8b;
7. Tighten the locking nut on the active end to fasten the prestressing tool to the temporary anchor, remove the hydraulic jack, and leave the adhesive for curing at room temperature for, e.g., 24 hours;
8. Release the locking nut, disassemble the prestressing tools from the CFRP laminate, and remove the rest components of the prestressing system.

A detailed description of the stepwise prestressing method and the components of the prestressing system is included in the appended Paper I.

3 Experimental program

The experimental program carried out in this study aims to study the application of CFRP laminates to the RC beam using the stepwise prestressing method and investigate the effectiveness of the bonded prestressed CFRP regarding the flexural strengthening of the beam. The experimental tests also serve to calibrate the FE and NLFE models to provide reliable predictions of interfacial stresses in the bonded CFRP laminates and the flexural behavior of the beam specimens.

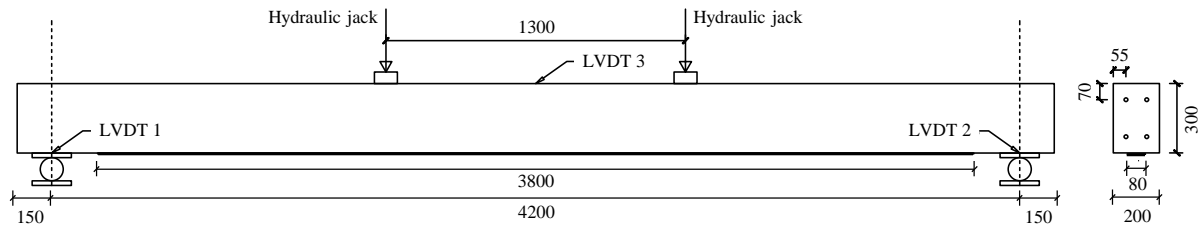

Figure 3.1 The RC beam specimen strengthened with a CFRP laminate and subjected to the four-point bending test

Three identical RC beams were prepared in the laboratory and subjected to a four-point bending configuration, see Figure 3.1. The first beam (B1) was not strengthened and served as a reference specimen. The second beam (B2) was strengthened with an unstressed CFRP laminate. The third beam (B3) was pre-loaded with 30 kN to the crack stage, unloaded, and then strengthened with the same CFRP laminate as B2 but stressed with the stepwise prestressing method. The maximum prestressing force from the hydraulic pump reached 100 kN with the observation of a maximum pre-strain up to 4.0‰ (31% of $\epsilon_{f,u}$) in the laminate. After the curing of the epoxy adhesive and the removal of the prestressing system, the maximum pre-strain dropped to 3.6‰ and 3.5‰ (ca. 27% of $\epsilon_{f,u}$), respectively. The variation of the maximum pre-strain in the CFRP laminate is shown in Figure 3.2. During testing, the specimens were subjected to monotonic loads applied in a displacement-controlled manner with the speed of 1 mm per minute. Linear variable differential transducers (LVDT) were installed at the midspan and the two supports in order to obtain the net deflection at the midspan. Strain gauges were installed on the CFRP laminates to monitor the axial strains in the laminates. More details of the instrumentation and measurements are described in Paper I.

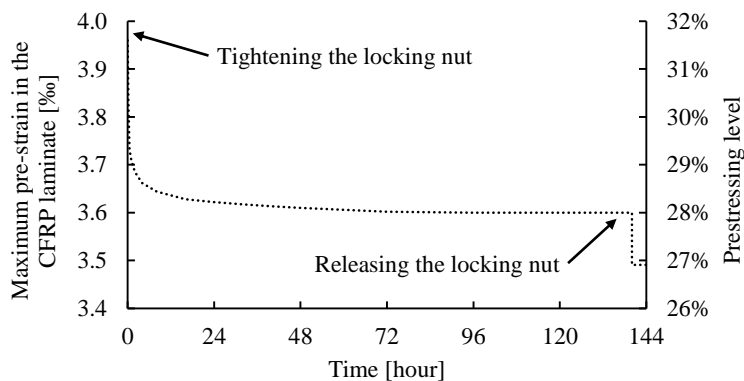

Figure 3.2 Variation of the maximum pre-strain in the CFRP laminate during 144 hours after prestressing. ‘Tighten the locking nut’ means the end of the prestressing process; ‘releasing the locking nut’ means removing the prestressing system; Prestressing level is equal to the ratio of the pre-strain to the ultimate strain of the CFRP laminate $\epsilon_{f,u}$

The materials properties of the RC beams, CFRP laminates, and the adhesive are summarized in Table 3.1. A detailed description can be found in Paper II.

Table 3.1 Dimension and material properties

Concrete C35/45			
Age on the testing day		day	287
Compressive strength on the testing day	f_c	MPa	58.6
Tensile strength on the testing day ¹	f_{ct}	MPa	3.6
Modulus of elasticity on the testing day ¹	E_c	GPa	36.9
Poisson's ratio ¹			0.2
Steel reinforcement bars K500C			
Diameter of longitudinal rebars ²	d_s	mm	16
Elastic modulus (mean value)	E_s	GPa	201
Yield stress (mean value)	$f_{s,y}$	MPa	510
Ultimate tensile stress (mean value)	$f_{s,u}$	MPa	618
Ultimate tensile strain	$\varepsilon_{s,u}$	strain	0.12
CFRP laminate StoFRP IM 80C			
Calibrated dimension of the plate	$b_f \times t_f$	mm	80×1.45
Tensile elastic modulus (mean value)	E_f	GPa	214
Ultimate tensile strain (minimum value)	$\varepsilon_{f,u}$	-	12.7‰
Adhesive StoPox SK41			
Design thickness of the adhesive layer	t_a	mm	1
Elastic modulus ³	E_a	GPa	7.1
Tensile strength ³		MPa	34
Poisson's ratio ⁴		-	0.3

¹ according to CEB-FIP (fib, 2013);
² stirrups have a diameter of 10 mm with a spacing of 75 mm;
³ according to the test after 14 days of curing at room temperature (Heshmati et al. 2017)
⁴ according to the supplier

4 Numerical analysis

Numerical analyses in this study can be categorized into two levels. The first level includes the linear FE analyses of applying the prestressed CFRP laminate to beam B3 with a focus on the stress state in the prestressed laminate and the CFRP-concrete bond line (see Paper I). The FE analyses also provide a comparison of the stress states between the stepwise prestressing method and the conventional prestressing approach to deliver a better understanding of the self-anchored laminate. Linear-elastic properties are assigned to materials for simplification since the nonlinear behavior is negligible in the phase of prestressing. The analyses in the second level include the NLFE modeling of the three beams subjected to the four-point bending test (see Paper II). The aim is to develop reliable FE models with the accurate prediction of the flexural behavior (e.g. load-deflection relation). Based on the verified NLFE models, parametric studies can be performed to provide optimization recommendations for the application of the stepwise prestressing method for flexural strengthening.

Numerical analyses were performed in the commercial FE software ABAQUS (Simulia, 2014b). Two-dimensional (2D) models were created and solved in ABAQUS standard (implicit) analysis. Since the geometry of the beams and the loading condition were symmetric about the midspan section, one half of the specimen was modeled to save computational efforts. Concrete material was modeled with 4-node plane stress solid elements using reduced Gauss integration (CPS4R); steel reinforcement bars and CFRP laminates used one-dimensional truss elements (T2D2). The external load was applied as an imposed displacement. More details of the modeling (e.g. steel bars, CFRP laminates, and CFRP-concrete adhesive joint) can be found in the appended Paper I and Paper II. The following discussion puts emphasis on (a) the nonlinear modeling of concrete with a concrete damaged plasticity (CDP) model (Simulia, 2014a), (b) mesh sensitivity analysis, and (c) the bond between steel reinforcement and concrete.

4.1 Nonlinear modeling of concrete

The concrete material in this study adopted the CDP model in order to capture the inelastic deformation of concrete after reaching the material strength. In the CDP model, properties in the three categories were required, including plasticity parameters, tensile behavior, and compressive behavior.

Plasticity parameters

Default values were assigned to plasticity parameters according to ABAQUS manual (Simulia, 2014a) except for dilation angle and viscoplastic parameter. In the CFP model, the Drucker-Prager hyperbolic plastic potential function is adopted; the inclination of the plastic potential function is specified by the dilation angle at high confining pressure (Simulia, 2014a). Increasing the defined value of the dilation angle will produce the behavior changing from brittle to more ductile. Studies reviewed by Malm (2009) show that the dilation angle should be defined between approximately 25 and 40 degrees to describe normal grade concrete subjected to biaxial stress states. Using a value in the higher range will result in a better description of the behavior at a low degree of confining pressure. In the analyses presented in the appended Paper II, the dilation angle defined in the FE models of B1, B2, and B3 is 35, 45, and 55 degrees, respectively. Parametric studies of the dilation angle in the range of 15 to 55 degrees were carried out in the analyses to quantify the effect of the dilation angle. For instance, the effect on the predicted load-deflection curves of specimen B2 is shown in Figure 4.1. A detailed discussion of the dilation angle can be found in the appended Paper II.

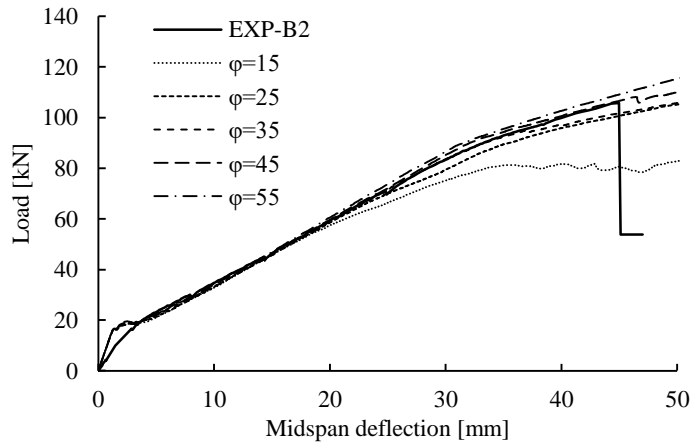

Figure 4.1 The effect of dilation angles on the FE prediction of load-deflection curves of specimen B2; φ denotes the dilation angle (unit: degree)

The viscoplastic parameter is used to regularize the CDP model by permitting stresses to be outside of the yield surface and overcome the severe convergence difficulties. The convergence difficulties are commonly observed in the implicit analysis of ABAQUS/Standard due to the strain softening behavior of cracked concrete or the damage evolution of bond behavior at the CFRP-concrete interface. The default value of the viscoplastic parameter is zero, which means that no viscoplastic regularization is performed. Defining a small value (small compared to the characteristic time increment) to the viscoplastic parameter introduces a viscoplastic regularization of the constitutive equations, which causes the consistent tangent stiffness of the softening concrete to become positive for sufficiently small time increments (Simulia, 2014a). The FE analysis carried out in this study has shown that the viscoplastic regularization could effectively solve the convergence problem. In the analyses of all three beams, the viscoplastic parameter is defined to be 10^{-4} . The effect of the viscoplastic parameters was investigated and presented in the appendix Paper II. For instance, Figure 4.2 shows the parametric study of the viscoplastic parameter based on the analyses of specimen B2.

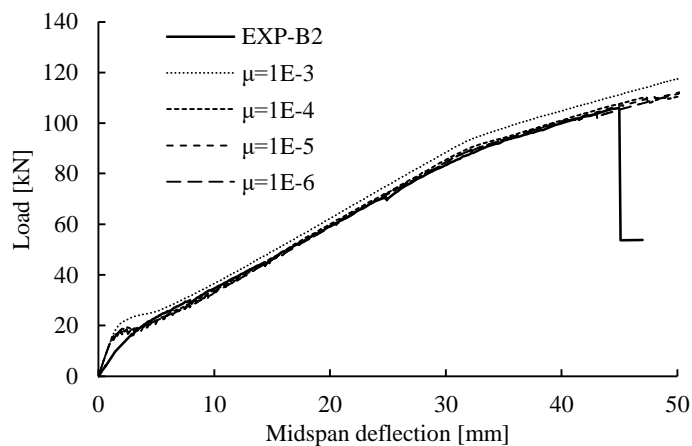

Figure 4.2 The effect of viscoplastic parameters μ on the FE prediction of load-deflection curves of specimen B2

Tensile and compressive behavior

Concrete behavior in tension and compression were defined in stress-strain relations according to CEB-FIP (fib, 2013). The smeared crack method was used to model the cracking of concrete under tensile loading, which converted the physical stress-crack opening curve to a stress-strain curve, see Figure 4.3. Thus, the cracked concrete was modeled as a strain-softening continuum, where the inelastic part of deformation due to crack openings w was described as a cracking strain ε_c smeared over a certain length

(named smeared length l_s). The smeared length l_s specifies the actual width of the fracture process zone in cracking concrete, see Figure 4.3. A reasonable value assumed for the smeared length guarantees the numerically simulated fracture zone comparable to that in reality. The smeared length in the NLFE models of the three beams is assumed to be 100 mm based on parametric studies. Figure 4.4 shows the effect of the smeared length on the predicted load-deflection curves of specimen B1. Detailed discussion is included in the appended Paper II.

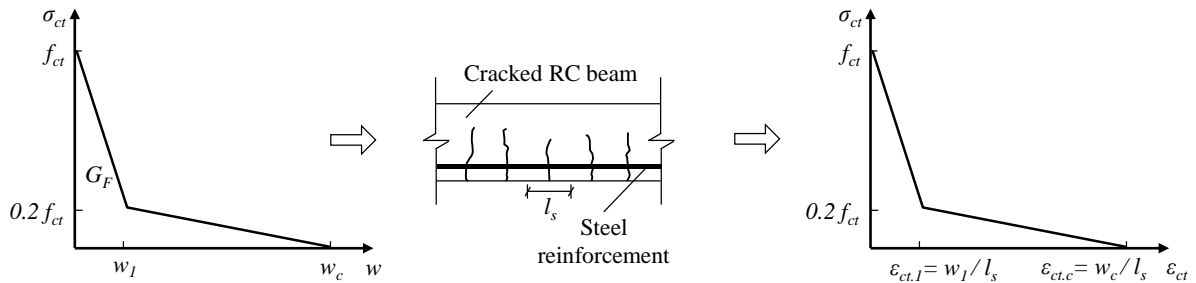

Figure 4.3 Implement the smeared crack method to convert a stress-crack opening curve to a stress-strain curve

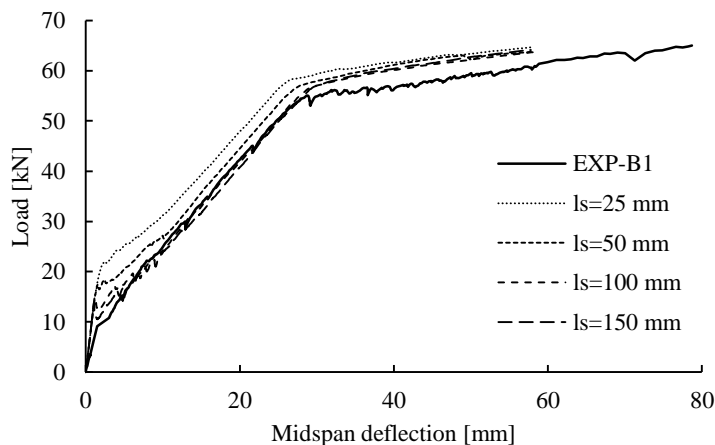

Figure 4.4 Identify the reasonable value of the smeared length based on the analyses of reference specimen B1

4.2 Mesh sensitivity analysis

The involvement of the smeared length in the modeling of cracked concrete means that the strain softening branch of the stress-strain relation depends on the assigned value of the smeared length. To ensure the objectivity of the FE analysis, two commonly used techniques are implemented and evaluated in this study to avoid the size-introduced bias. The first one is the crack band model. Instead of distributing the inelastic deformation (i.e. crack opening) over an assumed smeared length, the idea of the crack band model is to localize the softening of the fracture process zone into one element band. Thus, the strain softening of the post-peak branch turns to be adjusted by local mesh characteristics (e.g. the type and size of elements). Although the softening behavior becomes mesh-adjusted, the sensitivity of FE results (e.g. load-deflection relations) to the element size can be theoretically avoided according to the crack band model as well-explained by Bazant and Oh (1983). The second technique is the localization limiter approach. The localization limiter with a user-defined length is used as the smeared length to obtain the stress-strain relation in tension. The length of the localization limiter can be adjusted in scale so that the numerically simulated fracture process zone has the correct width compared to the that in reality (Jirasek & Bazant, 2002).

Both of these two techniques were implemented in the NLFE analyses of the beam specimens subjected to four-point bending tests. Mesh sensitivity analyses were carried out to evaluate the effectiveness of the two techniques with regard to reducing the sensitivity of load-deflection curves to element sizes. The mesh sensitivity analyses have revealed that using the localization limiter approach is able to deliver mesh-insensitive load-deflection curves exhibiting close match with the experimental results (assuming the proper limiter length/smear length of, e.g., 100 mm). However, the crack band model fails in reducing the sensitivity to the element size since the idea of strain localization into one element band cannot be guaranteed when assuming the perfect bond between steel reinforcement and concrete (see Section 4.3). The comparison between the two techniques is shown in Figure 4.5, which summarizes the results of the mesh sensitivity analyses based on the reference beam B1.

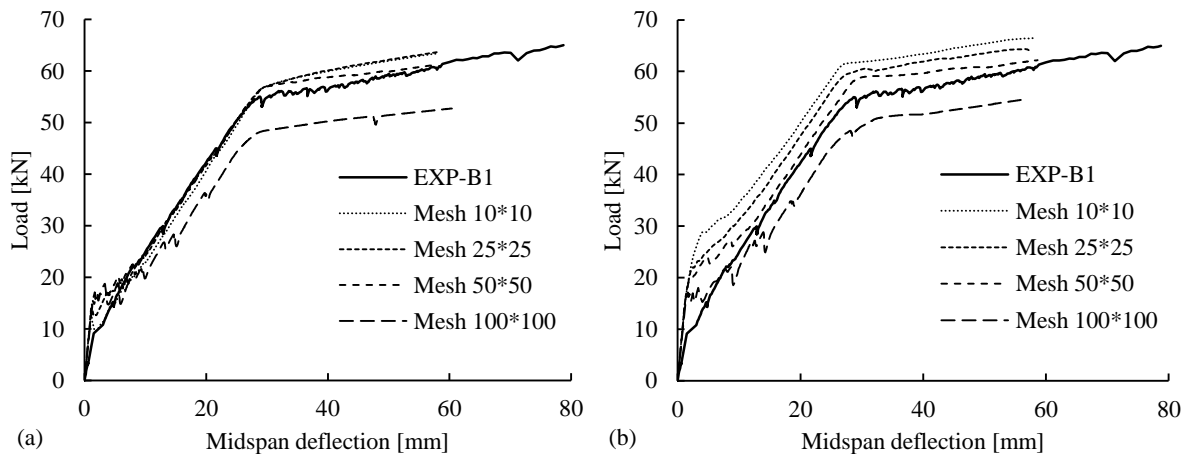

Figure 4.5 Mesh sensitivity analysis when using (a) the localization limiter approach and (b) the crack band method, covering the mesh sizes (the side length of square-elements) of 10 mm, 25 mm, 50 mm, and 100 mm.

4.3 Bond behavior between steel reinforcement and concrete

The steel reinforcement, including both longitudinal bars and stirrups, were ‘embedded’ in the concrete continuum. Perfect bond was assumed at the steel reinforcement/concrete interface without the consideration of relative slip, which meant that the nodes of steel reinforcement and concrete were constrained to each other to maintain the same strain. The effects of assuming the perfect bond on the FE analysis of the flexural behavior might include:

- Incapability to reduce the sensitivity of the load-deflection curves to the element size when using the crack band method. The fundamental principle of the crack band model is to localize the strain softening of the fracture process zone into one element band so that the strain softening of the post-peak branch becomes adjusted by the characteristic length of elements. However, if the perfect bond is defined at steel reinforcement/concrete interface, the strain localization cannot be guaranteed, and thus the characteristic length of elements is no longer suitable to supplement the stress-strain behavior of the fracture process zone (Johansson, 2000; Plos, 1995);
- Crack pattern with more number of cracks than that in reality. Numerical studies by Chen et al. (2011) have concluded that, compared with adopting the objective bond-slip model at the steel/concrete interface, assuming the perfect bond could lead to a crack pattern with more secondary cracks and smaller crack spacings for the main flexural cracks;
- Inaccurate prediction of IC debonding. Considering that the crack pattern (or crack spacings) has a significant effect on the prediction of IC debonding of the laminate (Teng et al. 2006; Chen et al. 2007), the IC debonding cannot be accurately captured by the FE models if the perfect bond is assumed.

However, in the current NLFE analysis with a focus on the load-deflection relation, the assumption of the perfect bond is acceptable since the bond behavior has a negligible effect on the prediction of the load-deflection curves (Chen et al. 2011). Mesh sensitivity is also avoided by using the localization limiter approach. As shown in Figure 4.6, the current FE models are able to deliver load-deflection curves that match closely with the experimental measures, while the difference in B3 is due to the simplification in the modeling which does not consider the cracked condition of the beam caused by the pre-loading before the prestressed strengthening. A proper bond-slip model at the steel reinforcement/concrete interface would become necessary in the further studies for crack patterns and the prediction of IC debonding in RC beams externally bonded with CFRP laminates.

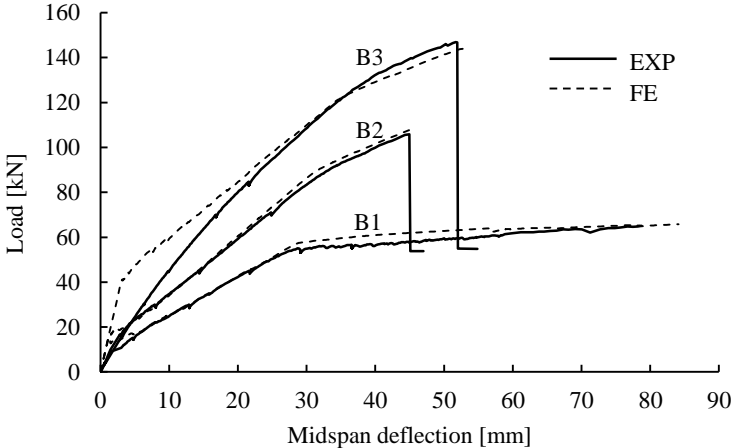

Figure 4.6 Comparison of the load-deflection curves between NLFE predictions and experimental results

5 Experimental and numerical results

5.1 Applying prestressed CFRP laminates to RC beams

Implementing the stepwise prestressing method

Owing to the prestressing tool, applying the CFRP laminate with the stepwise prestressing method is characterized by creating a gradually decreasing profile of the axial force towards the laminate ends over an extended length. Figure 5.1 shows the axial strains in the prestressed CFRP laminate applied to the beam B3 during prestressing. The maximum prestressing force P_0 introduced to the CFRP laminate is equal to 98 kN. The distribution profiles of the pre-strains exhibit an anchorage length of approximately 1250 mm, over which the axial stress in the laminate is gradually reducing towards the end with a relatively low gradient. The interfacial shear stresses are controlled by manipulating the gradient of axial force in the laminate. Figure 5.2 shows that the prestressed CFRP laminate is self-anchored to the beam B3 after removing the prestressing system without installing any end anchors.

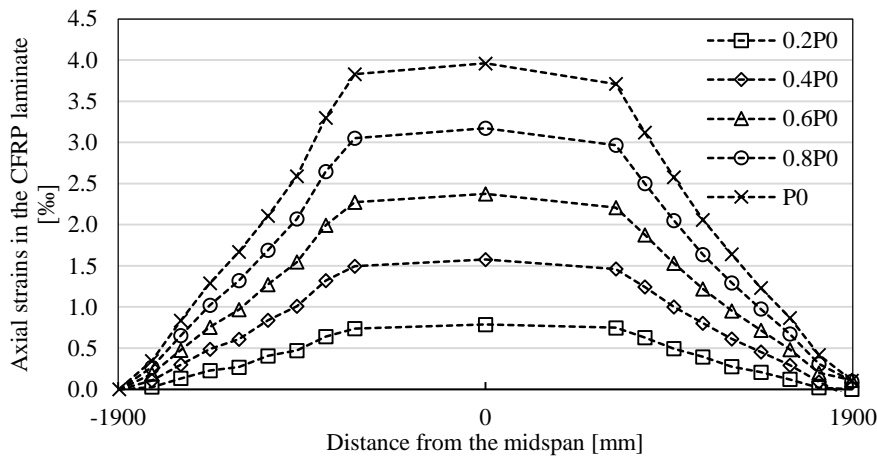

Figure 5.1 Axial strain in the CFRP laminate during the prestressing phase

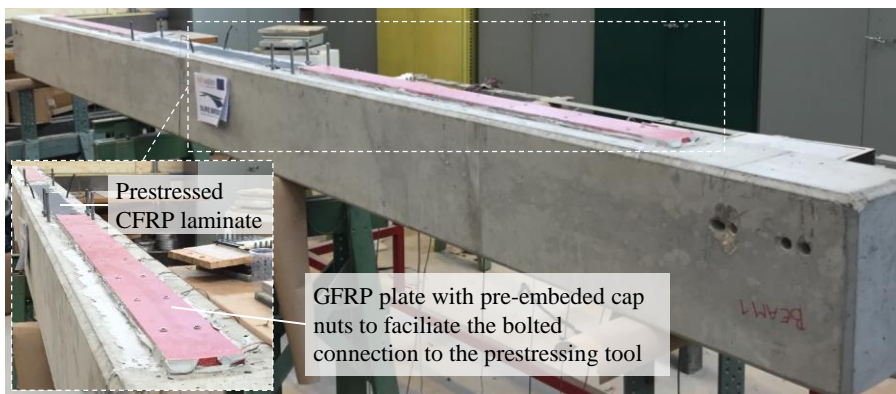

Figure 5.2 Self-anchorage of prestressed CFRP laminate on the RC beam

Interfacial stresses in the CFRP-concrete adhesive joint

The interfacial stresses built up along the CFRP-concrete adhesive joint were investigated in the FE analyses. Figure 5.3 shows the FE results of the axial strain in the self-anchored laminate after removing the prestressing system and the shear stresses in the adhesive layer and the concrete (1-mm beneath the concrete surface). The FE results reveal that the peak value of the shear stress in the adhesive τ_s is significantly reduced from 85.6 MPa in the conventional prestressing approach to 2.6 MPa by using the stepwise prestressing method; the peak value of the shear stress in the concrete $\tau_{c.1mm}$ is also reduced

from 19.6 MPa to 0.9 MPa. These reduced peak shear stresses in the adhesive and the concrete are well below the bond strength of the CFRP-concrete adhesive joint and the concrete strength, respectively. The bond strength of the adhesive joint, for instance, is calculate to be 5.7 MPa according to equation Eq.1 (Lu et al. 2005).

$$\tau_{max} = 1.50f_{ct} \sqrt{\frac{2.25 - b_f/b_c}{1.25 + b_f/b_c}} \quad \text{Eq. 1}$$

where f_{ct} is the concrete tensile strength; b_f and b_c are the widths of the CFRP laminate and the concrete beam, respectively.

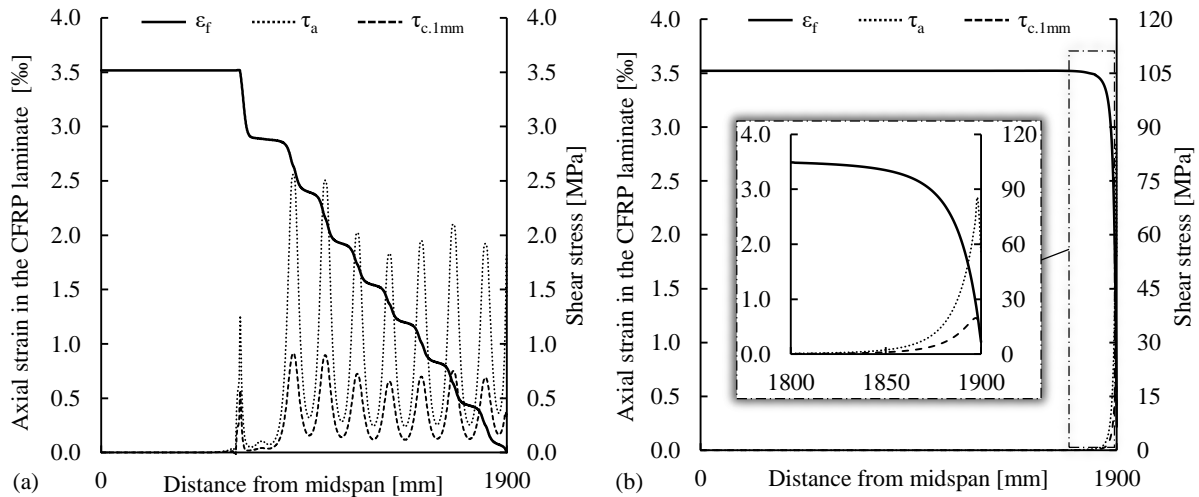

Figure 5.3 FE results of the axial strain in the prestressed CFRP laminate τ_s , the shear stresses in the adhesive layer τ_s , and the shear stress in the concrete $\tau_{c,1mm}$ (1-mm beneath the concrete surface) after removing the prestressing system

5.2 Flexural performance of strengthened beams

Three beam specimens are subjected to the four-point bending tests and evaluated regarding the flexural performance in the SLS and ULS, including bending stiffness, crack width, ultimate capacity and the utilization of CFRP laminates. The performance of the specimen B3 strengthened with the self-anchored prestressed CFRP laminate is compared to the reference specimen B1 (un-strengthened) and the specimen B2 (strengthened with an unstressed CFRP laminate). The comparison of experimental results highlights the effectiveness of the prestressing method regarding the flexural strengthening with the self-anchored prestressed CFRP laminate in B3.

Load-deflection relations

The bending stiffness and the ultimate loads are specified in Figure 5.4, which shows the experimental load-deflection curves of the beams. The bending stiffness in the SLS was calculated at the deflection of 17 mm (net span/250) according to the load-deflection curves. The result showed that, even though specimen B3 was pre-loaded to the cracking stage before strengthening, using the prestressed CFRP laminate in B3 enhanced the bending stiffness by 103% and 43% compared to the reference specimen B1 and the specimen B2, respectively. The improved bending stiffness in B3 can be attributed to the self-anchored prestressed CFRP laminate, which introduces a compressive force with eccentricity acting on the beam and thus increases the height of the compressive zone and the moment of inertia in the cracked sections. In the ULS, the failure mode of B2 and B3 is the IC debonding of CFRP laminates.

Owing to the prestressed strengthening, the ultimate capacity of B3 further increased by 39% in comparison to that of B2 using unstressed CFRP laminate.

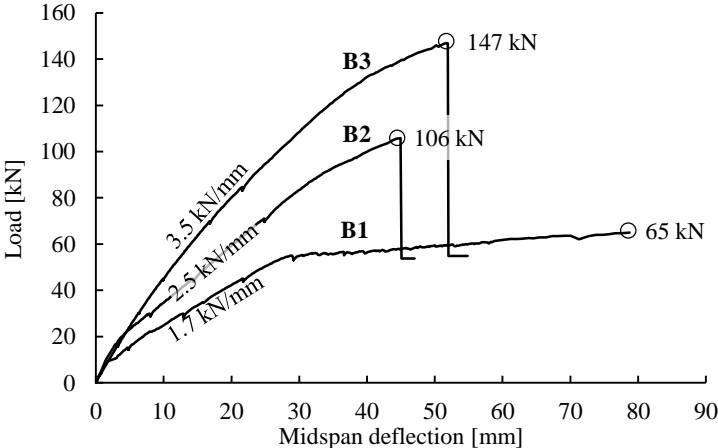
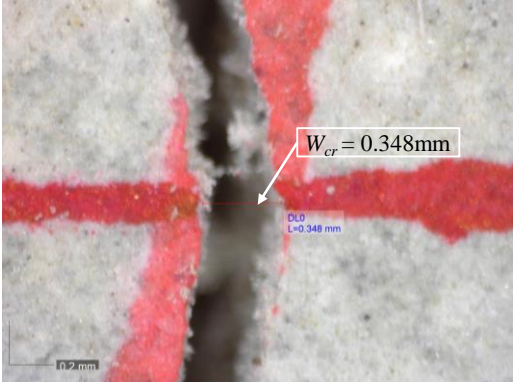

Figure 5.4 Experimental results of the load-deflection curves for specimens B1 (un-strengthened), B2 (strengthened with an unstressed CFRP laminate), and B3 (strengthened with the self-anchored prestressed CFRP laminate)

Crack widths

The measurements of the cracks during loading showed that the prestressed strengthening in B3 effectively reduced the crack widths in the beam. The width of crack openings was measured in the level of longitudinal steel reinforcement bars with the aid of a digital microscope camera, see Figure 5.5a. The maximum crack widths in the specimens at different load levels are shown in Figure 5.5b. At the beginning of loading, the maximum crack widths in B1 and B2 were ca. 0.3 mm since several shrinkage cracks were observed at the arrival of the beams in the lab. In B3, even though the maximum width of these initial cracks increased to 0.6 mm due to the pre-loading till 30 kN, the cracks were fully closed after the prestressed strengthening with the self-anchored CFRP laminate.



(a)

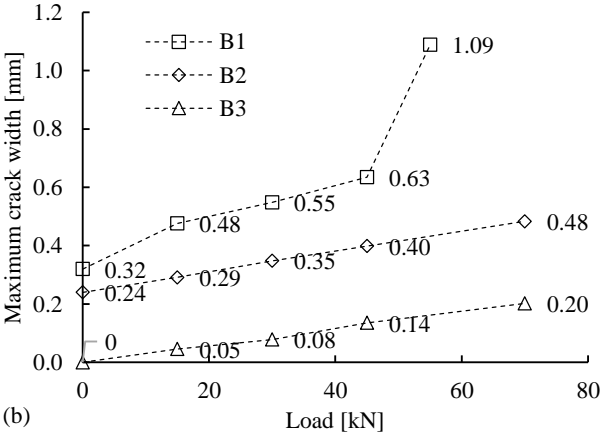

(b)

Figure 5.5 (a) Measurement of the crack width with the aid of a digital microscope camera; (b) Maximum crack width measured in three beams at different load levels during testing

The comparison of maximum crack widths in Figure 5.5b indicates that strengthening with CFRP laminate in B2 and B3 can reduce the growth rate of the maximum crack width to the increment of external load in comparison with the reference specimen B1. The significant growth of the crack width at the yielding state of steel reinforcement (e.g. observed in B1 at 55 kN shortly after the yielding load of 54.4 kN) is also delayed due to the increase of yielding load after the CFRP laminate strengthening.

The comparison between B2 and B3 highlighted the advantages of using the prestressed laminate. The application of prestressed laminate in B3 resulted in the closure of the initial cracks due to shrinkage and pre-loading and thus effectively reduced the maximum crack width during testing. According to the requirement of crack control in Eurocode 2 (EN 1992, 2005), the maximum allowed crack width is 0.3 mm for RC members with exposure class XD (risk of corrosion induced by chlorides). In the loading phase of B3, the critical load at the maximum allowed crack width is substantially increased to 112 kN (assuming that the crack width grows in a linear relation to the increase of the load from 70 kN to the yield load of 118 kN), while the corresponding load in B2 was only ca. 15 kN.

Utilization of CFRP laminates

The effectiveness of the implemented prestressing method was also demonstrated by the utilization ratio of the self-anchored CFRP laminate at failure. Even though no mechanical end anchor was installed in beam B3, the utilization ratio of the self-anchored CFRP laminate reached 81% at debonding, which was greatly higher than the ratio of 47% in B2. The increased utilization ratio in B3 included the 27% exploited by prestressing and the 7% due to the delayed IC debonding as a benefit from the reduced crack widths after the prestressed strengthening.

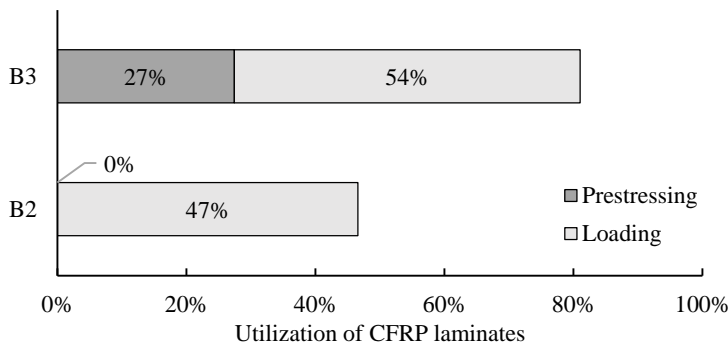

Figure 5.6 Utilization of the CFRP laminates in the prestressing and loading phases

5.3 Optimization of the prestressed CFRP strengthening

Based on the NLFE models verified with the experimental results, parametric studies were performed to investigate the effects of the prestressing level and the elastic modulus of the CFRP laminate on the flexural behavior (e.g. load-deflection relation) of strengthened beams. The studies aimed to provide the optimization recommendations for the application of the prestressed CFRP laminates regarding the flexural strengthening of RC beams. The flexural performance was evaluated with respect to ultimate capacity and ductility. In the ultimate state, three types of failure modes were considered, including (1) concrete crushing in compressive zones, (2) the rupture of CFRP laminates, and (3) the debonding of CFRP laminate due to intermediate cracks (IC debonding). The ductility denoted by μ_{Δ} was calculated according to equation Eq. 2.

$$\mu_{\Delta} = \Delta_u / \Delta_y \quad \text{Eq. 2}$$

where Δ_y and Δ_u are the corresponding deflections at the yielding and the ultimate loads, respectively.

Prestressing level

The parametric study on the prestressing levels in the range of 0% to 50% is shown in Figure 5.7. The FE analyses based on the configuration of specimen B3 indicated that increasing the prestressing level resulted in (a) a higher ultimate capacity, (b) the delayed IC debonding of the laminate at a higher

utilization ratio, and thus (c) the increased risk of failure due to the concrete crushing or the rupture of the CFRP. As a result, the change of failure mode caused a decrease in the ductility, e.g., in the case with the prestressing level of 40% or 50%. When the prestress level increased to 50%, the failure mode changed to the concrete crushing in the region under the load print. If the concrete crushing failure could be avoided, e.g., by using a higher concrete class, the failure mode would shift from the concrete crushing to the rupture of CFRP laminate instead of the IC debonding.

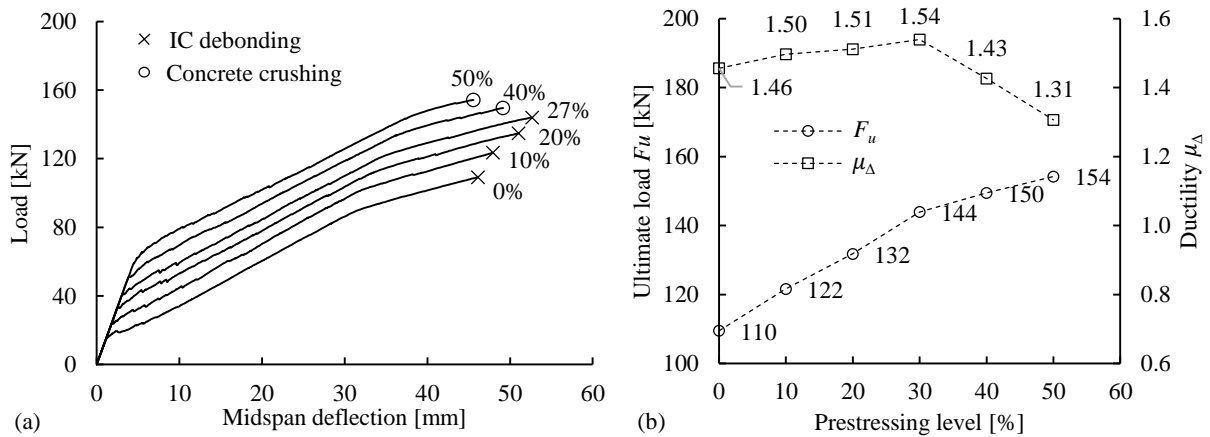

Figure 5.7 Parametric study on the prestressing level in the range of 0 to 50%: (a) load-deflection curves from the FE prediction with the failure mode specified; (b) the ultimate load and the ductility according to the load-deflection curves

The elastic modulus of CFRP laminates

The commercially available CFRP laminates usually have an elastic modulus in the range of 170 to 230 GPa. The parametric study on the elastic modulus, see Figure 5.8, indicates that using a stiffer (i.e. higher elastic modulus) CFRP laminate leads to (a) a higher bending stiffness after the cracking stage, (b) a delayed yielding of steel reinforcement bars, and (c) a higher risk of concrete crushing failure. For instance, although increasing the elastic modulus from 214 GPa to 230 GPa enhanced the bending stiffness, it resulted in a decrease in the ultimate capacity and the ductility due to the change of failure mode to concrete crushing. Considering the higher price of stiffer laminate products, in specimen B3, a stiffer CFRP laminate than the currently used one (214 GPa) is not recommended for the prestressed strengthening.

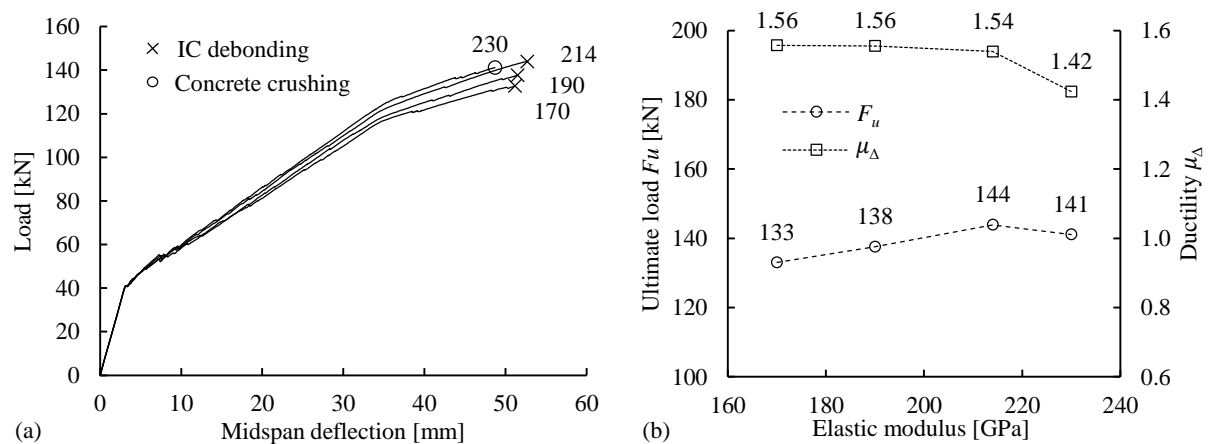

Figure 5.8 Parametric study on the elastic modulus of CFRP laminates in the range of 170 to 230 GPa: (a) load-deflection curves from the FE prediction with the failure mode specified; (b) the ultimate load and the ductility according to the load-deflection curves

6 Conclusions and future study

This thesis investigates the stepwise prestressing method adopted as the core technique of the proposed SUREBRIDGE refurbishment solution. The method has been developed for the application of prestressed CFRP laminates used as externally bonded reinforcement for the flexural strengthening of RC structures. The implementation of the method aims to avoid the significant stress concentration at the ends of bonded laminates and thus realize the self-anchorage of the prestressed laminates in order to eliminate the need for conventional end anchors.

The experimental and numerical studies were carried out to evaluate the effectiveness of the method regarding the application and self-anchorage of prestressed CFRP laminates for the flexural strengthening of RC beams.

The experimental implementation of the method has concluded that the self-anchorage of the prestressed CFRP laminate can be realized without installing conventional end anchors. The FE analysis of the interfacial stresses has also shown that there is a sufficient safety margin for the self-anchored laminate regarding the ratio of the CFRP-concrete bond strength to the interfacial stresses.

- The bonded CFRP laminate in the beam B3 was prestressed with a force up to 100 kN and self-anchored to the beam after removing the prestressing system with a maximum prestressing level of 27%;
- The FE analysis of the interfacial stresses showed that, owing to the stepwise prestressing method, the peak values of the shear stress in the adhesive layer and the concrete (1 mm beneath the surface) were reduced to 2.6 MPa and 0.9 MPa, respectively. The bond strength of the adhesive joint and the strength of concrete were sufficient to resist the reduced interfacial stresses.

The experimental results of the four-point bending tests have shown that, even although end anchors are not used, the self-anchored CFRP laminate can perform its function during the loading phase and effectively improve the flexural performance of the strengthened RC beam in SLS and ULS. A high utilization ratio can be achieved in the self-anchored laminate at failure.

- Even though the specimen B3 was pre-loaded to the cracking stage before strengthening, applying the self-anchored prestressed CFRP laminate to B3 enhanced the bending stiffness by 103% and 43% compared to reference beam B1 (un-strengthened) and beam B2 (strengthened with unstressed CFRP), respectively;
- The measurement of crack widths in three specimens showed that using the prestressed CFRP laminate in B3 not only reduced the growth rate of crack widths but also fully closed the initial crack openings due to shrinkage and pre-loading;
- The comparison of ultimate loads showed that using the self-anchored prestressed CFRP laminates in B3 can increase the ultimate load by 126% and 39% compared to B1 and B2, respectively;
- The utilization ratio of the self-anchored CFRP laminate in B3 reached 81% at the moment of IC debonding, which consisted of 27% exploited by the prestressing and 54% built up during loading.

Based on the parametric studies on the prestressing level and the elastic modulus of CFRP laminates carried out in numerical analyses, the optimization recommendations for the application of prestressed CFRP laminates include:

- Increasing the prestressing level is an efficient way to enhance flexural capacity effectively. A higher prestressing level also delays the IC debonding of CFRP laminates at a higher utilization

ratio. The delayed debonding means that the failure mode may shift from the debonding to concrete crushing or rupture of laminates, which usually results in the reduction in the ductility;

- Using CFRP laminates with a higher elastic modulus can increase the bending stiffness of the strengthened RC beam after the cracking stage, but it is not worth choosing the laminate product as stiff as possible. Using the laminate with a higher elastic modulus increases the risk of failure due to the concrete crushing in the compressive zone, which may reduce both the ductility and the ultimate capacity.

The study in the future is to upgrade the current NLFE models and extend the scope to cover the SUREBRIDGE refreshment solution:

- The NLFE models will adopt the physical bond-slip behavior between steel reinforcement and concrete and define a proper behavior with plastic degradation between the concrete and the externally bonded CFRP laminate. These upgraded models are expected to deliver reliable crack patterns and the accurate prediction of IC debonding. To achieve these, the explicit analysis program of ABAQUS might be used instead of the implicit analysis;
- As proposed in the SUREBRIDGE solution, the combination use of the prefabricated GFRP deck installed on the top of the existing concrete deck and the prestressed CFRP laminate on the bottom surface is to be investigated in experimental and numerical approaches and evaluated with respect to the effectiveness of flexural strengthening.

7 References

- Al-Emrani, M., & Kliger, R. (2006). Analysis of interfacial shear stresses in beams strengthened with bonded prestressed laminates. *Composites Part B: Engineering*, 37(4–5), 265–272. <https://doi.org/10.1016/j.compositesb.2006.01.004>
- Aslam, M., Shafiqh, P., Jumaat, M. Z., & Shah, S. N. R. (2015). Strengthening of RC beams using prestressed fiber reinforced polymers – A review. *Construction and Building Materials*, 82, 235–256. <https://doi.org/10.1016/j.conbuildmat.2015.02.051>
- Bakis, C. E., Bank, L. C., Brown, V. L., Cosenza, E., Davalos, J. F., Lesko, J. J., Machida, A., Rizkalla, S. H., and Triantafillou, T. C. 2002. “Fiber-Reinforced Polymer Composites for Construction—State-of-the-Art Review.” *Journal of Composites for Construction* 6 (2): 73–87. [https://doi.org/10.1061/\(ASCE\)1090-0268\(2002\)6:2\(73\)](https://doi.org/10.1061/(ASCE)1090-0268(2002)6:2(73)).
- Bazant, Z. P., & Oh, B. H. (1983). Crack band theory for fracture of concrete. *Matériaux et Construction*, 16(3), 155–177. <https://doi.org/10.1007/BF02486267>
- Bien, J., Elfgrén, L., & Olofsson, J. (2007). *Sustainable bridges: assessment for future traffic demands and longer lives*. Dolnoslaskie Wydawnictwo Edukacyjne.
- Brunner, M., & Schnueriger, M. (2005). Timber Beams Strengthened by Attaching Prestressed Carbon FRP Laminates with a Graded Anchoring Device. In *Proceedings of the International Symposium on Bond Behaviour of FRP in Structures (BBFS 2005)*.
- CEN. (2005). *Eurocode 2: Design of concrete structures — Part 1-1: General rules and rules for buildings* (No. EN 1992-1-1:2005). Brussels, Belgium: European Committee for Standardization (CEN).
- Chen G. M., Teng J. G., & Chen J. F. (2011). Finite-Element Modeling of Intermediate Crack Debonding in FRP-Plated RC Beams. *Journal of Composites for Construction*, 15(3), 339–353. [https://doi.org/10.1061/\(ASCE\)CC.1943-5614.0000157](https://doi.org/10.1061/(ASCE)CC.1943-5614.0000157)
- Chen, J. F., Yuan, H., & Teng, J. G. (2007). Debonding failure along a softening FRP-to-concrete interface between two adjacent cracks in concrete members. *Engineering Structures*, 29(2), 259–270. <https://doi.org/10.1016/j.engstruct.2006.04.017>
- Czaderski, C., Martinelli, E., Michels, J., & Motavalli, M. (2012). Effect of curing conditions on strength development in an epoxy resin for structural strengthening. *Composites Part B: Engineering*, 43(2), 398–410. <https://doi.org/10.1016/j.compositesb.2011.07.006>
- ECTP. (2005). *Strategic Research Agenda for the European Construction Sector*. European Construction Technology Platform (ECTP). Retrieved from www.ectp.org
- El-Hacha, R., Wight, R., & Green, M. (2001). Prestressed fibre-reinforced polymer laminates for strengthening structures. *Progress in Structural Engineering and Materials*, 3(2), 111–121. <https://doi.org/10.1002/pse.76>
- fib. (2013). *fib Model Code for Concrete Structures 2010*. John Wiley & Sons.
- Grelle, S. V., & Sneed, L. H. (2013). Review of Anchorage Systems for Externally Bonded FRP Laminates. *International Journal of Concrete Structures and Materials*, 7(1), 17–33. <https://doi.org/10.1007/s40069-013-0029-0>
- Haghani, R., Al-Emrani, M., & Kliger, R. (2015). A new method for strengthening concrete structures using prestressed FRP laminates. In *Proceeding of the 8th International Structural Engineering and Construction Conference* (pp. 1153–1158).
- Haghani, R., & Al-Emrani, M. (2016). A new method for application of pre-stressed FRP laminates for strengthening of concrete structures. In *proceeding of the 19th IABSE Congress* (pp. 1556–1563), Stockholm.
- Haghani, Reza, Al-Emrani, M., & Kliger, R. (2009). Interfacial stress analysis of geometrically modified adhesive joints in steel beams strengthened with FRP laminates. *Construction and Building Materials*, 23(3), 1413–1422. <https://doi.org/10.1016/j.conbuildmat.2008.07.013>
- Heshmati, M., Dogahneh, R. H., & Al-Emrani, M. (2017). Durability of bonded FRP-to-steel joints Effects of moisture, de-icing salt solution, temperature and FRP type. *Composites Part B: Engineering*, 119, 153–167. <https://doi.org/10.1016/j.compositesb.2017.03.049>
- Jirasek, M., & Bazant, Z. P. (2002). *Inelastic Analysis of Structures*. John Wiley & Sons.

- Johansson, M. (2000). *Structural behaviour in concrete frame corners of civil defence shelters: non-linear finite element analyses and experiments*. Ph.D. Thesis, Chalmers University of Technology, Gothenburg, Sweden.
- Kalfat, R., Al-Mahaidi, R., & Smith, S. T. (2013). Anchorage Devices Used to Improve the Performance of Reinforced Concrete Beams Retrofitted with FRP Composites: State-of-the-Art Review. *Journal of Composites for Construction*, 17(1), 14–33. [https://doi.org/10.1061/\(ASCE\)CC.1943-5614.0000276](https://doi.org/10.1061/(ASCE)CC.1943-5614.0000276)
- Kim, Y. J., Wight, R. G., & Green, M. F. (2008a). Flexural Strengthening of RC Beams with Prestressed CFRP Sheets: Development of Nonmetallic Anchor Systems. *Journal of Composites for Construction*, 12(1), 35–43. [https://doi.org/10.1061/\(ASCE\)1090-0268\(2008\)12:1\(35\)](https://doi.org/10.1061/(ASCE)1090-0268(2008)12:1(35))
- Kim, Y. J., Wight, R. G., & Green, M. F. (2008b). Flexural Strengthening of RC Beams with Prestressed CFRP Sheets: Using Nonmetallic Anchor Systems. *Journal of Composites for Construction*, 12(1), 44–52. [https://doi.org/10.1061/\(ASCE\)1090-0268\(2008\)12:1\(44\)](https://doi.org/10.1061/(ASCE)1090-0268(2008)12:1(44))
- Kliger, I. R., Haghani, R., Brunner, M., Harte, A. M., & Schober, K.-U. (2016). Wood-based beams strengthened with FRP laminates: improved performance with pre-stressed systems. *European Journal of Wood and Wood Products*, 74(3), 319–330. <https://doi.org/10.1007/s00107-015-0970-5>
- Kotynia, R., Staskiewicz, M., Michels, J., Czaderski, C., & Motavalli, M. (2015). Pioneering strengthening of bridge girders with pretensioned CFRP laminates in Poland. *Proceedings of SMAR 2015 the 3rd Conference on Smart Monitoring, Assessment and Rehabilitation of Civil Structures*.
- Kotynia, R., Walendziak, R., Stoecklin, I., & Meier, U. (2011). RC Slabs Strengthened with Prestressed and Gradually Anchored CFRP Strips under Monotonic and Cyclic Loading. *Journal of Composites for Construction*, 15(2), 168–180. [https://doi.org/10.1061/\(ASCE\)CC.1943-5614.0000081](https://doi.org/10.1061/(ASCE)CC.1943-5614.0000081)
- Lu, X. Z., Teng, J. G., Ye, L. P., & Jiang, J. J. (2005). Bond–slip models for FRP sheets/plates bonded to concrete. *Engineering Structures*, 27(6), 920–937. <https://doi.org/10.1016/j.engstruct.2005.01.014>
- Malm, R. (2009). *Predicting shear type crack initiation and growth in concrete with non-linear finite element method*. KTH Royal Institute of Technology, Stockholm, Sweden.
- Meier, U. (1995). Strengthening of structures using carbon fibre/epoxy composites. *Construction and Building Materials*, 9(6), 341–351. [https://doi.org/10.1016/0950-0618\(95\)00071-2](https://doi.org/10.1016/0950-0618(95)00071-2)
- PANTURA. (2011). *D5.3 - Needs for maintenance and refurbishment of bridges in urban environments*. Retrieved from <http://www.pantura-project.eu/>
- Plos, M. (1995). *Application of fracture mechanics to concrete bridges: finite element analyses and experiments*. Ph.D. Thesis, Chalmers University of Technology, Gothenburg, Sweden.
- Radomski, W. (2002). *Bridge rehabilitation*. London : Imperial College, cop. 2002.
- Simulia. (2014a). *ABAQUS 6.14: User's Manual*. Providence, RI: Dassault Systems.
- Simulia. (2014b). *ABAQUS/Standard 6.14*. Providence, RI: Dassault Systems.
- Stöcklin, I., & Meier, U. (2001). Strengthening of concrete structures with prestressed and gradually anchored CFRP strips. In *FRPRCS-5: Fibre-reinforced plastics for reinforced concrete structures Volume 1* (Vols. 1–0, pp. 291–296). Thomas Telford Publishing. <https://doi.org/10.1680/frprcsv1.30299.0030>
- Teng, J. G., Yuan, H., & Chen, J. F. (2006). FRP-to-concrete interfaces between two adjacent cracks: Theoretical model for debonding failure. *International Journal of Solids and Structures*, 43(18–19), 5750–5778. <https://doi.org/10.1016/j.ijsolstr.2005.07.023>
- Triantafillou, T. C., Deskovic, N., & Deuring, M. (1992). Strengthening of concrete structures with prestressed fiber reinforced plastic sheets. *ACI Structural Journal*, 89(3), 235–244.
- Yang, J., Haghani, R., & Al-Emrani, M. (2017). Flexural strengthening of reinforced concrete beams using externally bonded FRP laminates prestressed with a new method. In *Proceeding of the 4th International Conference on Smart Monitoring, Assessment and Rehabilitation of Civil Structures*. Zurich, Switzerland.
- Yang, J., Haghani, R., & Al-Emrani, M. (2018). Flexural FRP Strengthening of Concrete Bridges Using an Innovative Concept. In *Proceedings of the 9th International Conference on Bridge*

Maintenance, Safety and Management (p. 588). Melbourne, Australia: London: CRC Press.
<https://doi.org/10.1201/9781315189390>