



SelfPaint-A self-programming paint booth

Downloaded from: <https://research.chalmers.se>, 2026-04-05 04:13 UTC

Citation for the original published paper (version of record):

Edelvik, F., Tiedje, O., Jonuscheit, J. et al (2018). SelfPaint-A self-programming paint booth. *Procedia CIRP*, 72: 474-479. <http://dx.doi.org/10.1016/j.procir.2018.03.167>

N.B. When citing this work, cite the original published paper.

51st CIRP Conference on Manufacturing Systems

SelfPaint – A self-programming paint booth

Fredrik Edelvik^{a,*}, Oliver Tiedje^b, Joachim Jonuscheit^c, Johan S. Carlson^a

^aFraunhofer-Chalmers Centre, Chalmers Science Park, SE-412 88 Gothenburg, Sweden

^bFraunhofer IPA, Nobelstraße 12, D-70569 Stuttgart, Germany

^cFraunhofer ITWM, Fraunhofer Platz 1, D-67663 Kaiserslautern, Germany

* Corresponding author. Tel.: +46-730-794220; fax: +46-31-7724260. E-mail address: fredrik.edelvik@fcc.chalmers.se

Abstract

In this paper we present a unique Fraunhofer approach that aims towards a vision to automate the product preparation in paint shops by automatically generating robot paths and process conditions that guarantee a certain wanted paint coverage. This will be accomplished through a combination of state-of-the-art simulation technology, inline quality control by novel terahertz thickness measurement technology, and surface treatment technology. The benefits of the approach are a shortened product preparation time, increased quality and reduced material and energy consumption. The painting of a tractor fender is used to demonstrate the approach.

© 2018 The Authors. Published by Elsevier B.V.

Peer-review under responsibility of the scientific committee of the 51st CIRP Conference on Manufacturing Systems.

Keywords: Spray painting, computational fluid dynamics, immersed boundary method, automatic path planning, optimization, terahertz measurements

1. Introduction

Almost all products are coated, on the one hand for functional reasons, on the other hand, for decorative ones. The coating provides e.g. corrosion protection and an opportunity to meet the increasing requests for individualization of products. In addition to the need for rapid adaptability the industry also faces increased demands on sustainable production and reduction of energy and raw material consumption. As an example from the AUDI plant in Ingolstadt, Germany, that consists of press shop, body-in-white, paint shop and assembly, 53% of the total energy is consumed by the spray painting process. For the emissions of volatile organic components (VOCs) and hazardous air pollutants the paint shop processes are responsible for 99% [1]. The length of a coating line from the body-in-white shop to the final assembly is usually between two and three kilometers. Roughly 60 cars are coated per hour and the dwell time in the paint shop is about 8-11 hours [2]. This means that the paint shop not only has a large environmental impact it is also often a bottleneck in production. However, due to its great complexity the painting process offers many possibilities to improve the use of energy and raw material, and reduce emissions, that have direct impact on sustainable automotive production.

Virtual tools are frequently used to support an effective product and production realization, but such tools are not commonly used in the paint shops. In the paint shops the product preparation, when robot paths and process parameters are fine-tuned, is

a slow and costly trial-and-error procedure, where a large number of prototypes are painted until a satisfactory result has been obtained. There is therefore a great need to improve the product preparation process and this is absolutely necessary to meet the future demands on fast adaption and tailored solutions for new material combinations and products.

A common technique to apply paint is to use an Electrostatic Rotary Bell Sprayer, see Figure 3. Paint is injected at the center of a rotating bell; the paint forms a film on the bottom side of the bell and is atomized at the edge. The droplets are charged electrostatically and driven towards the target both by shaping air surrounding the rotating bell and by a potential difference in the order of 50-100kV between paint applicator and target. Therefore, we are facing a very complex process characterized by multi-phase flow, large moving geometries, multi-scale phenomena and even multiphysics aspects. For this reason general purpose software often require weeks of simulation time even on supercomputers, and in the literature only limited earlier work on modeling and simulation can be found [3–5]. A novel simulation framework that makes it possible to accurately simulate spray painting of e.g. a car or truck cab in only a few hours on a standard computer was recently presented [6,7]. This is an extreme improvement compared to earlier approaches. Unique algorithms for coupled simulations of air flows, electrostatic fields and charged paint particles make this possible.

In an ongoing Fraunhofer project with the institutes IPA, ITWM and FCC, the aim is to completely automate the generation of the robot programs and process parameters to guar-

antee a certain paint thickness and make even lot size 1 production possible. This will be accomplished through a combination of state-of-the-art simulation technology for multiphysics simulation of the spray painting process [6–9], automatic robot path planning [10,11], inline quality control by terahertz thickness measurement technology [12], and surface treatment technology. The benefits of the approach are a shortened product preparation time, increased quality and reduced raw material and energy consumption.

The rest of the paper is organized as follows: In the next section the different building blocks of the paint booth are briefly described. In Section 3 some initial results on a tractor fender are presented. The last section summarizes the paper and discusses future work.

2. Methodology

The architecture of the self-programming paint booth is divided into five main modules as illustrated in Figure 1, and briefly described in the following subsections.

In the first module the object is 3D-scanned and the resulting point cloud is used to generate a surface representation of the object, unless a CAD is readily available, and for positioning of the object in the paint booth. In the second and third modules, an optimal robot path and process parameters are determined based on multiphysics and projection-based simulations. After the painting in the fourth module, quality control is performed based on inline terahertz thickness measurements in the fifth module.

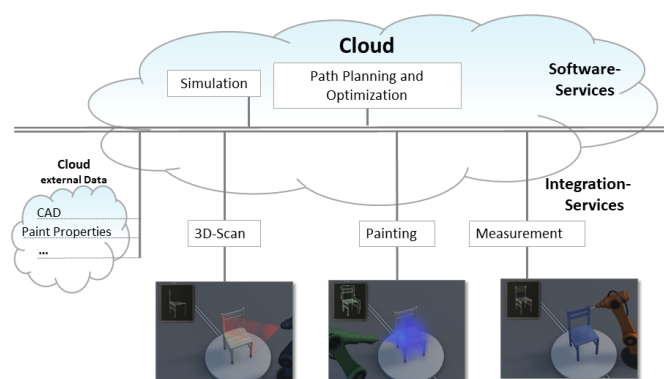

Fig. 1. The cloud architecture of the cyber-physical SelfPaint system.

2.1. 3D-scanning

The aim of the 3D-scanning module is the development of a cost-efficient and flexible solution for capturing 3D objects in the form of a point cloud and the subsequent positioning of the objects in the paint booth. This is realized by using the Kinect 2-sensor from Microsoft combined with image analysis algorithms. The position information of the object in the paint booth is then transferred to the simulation software and thickness measurement system.

2.2. Simulation technology

The multi-physics framework for simulation of electrostatically charged bells consists of the Navier-Stokes solver, IPS IBOFlow (Immersed Boundary Octree Flow Solver) [13], which is based on a finite volume discretization on a Cartesian octree grid that can be dynamically refined and coarsened. The Navier-Stokes equations are solved in a segregated way and the SIMPLEC method is used to couple the pressure and the velocity fields [14]. Unique immersed boundary methods are used to impose the boundary conditions on the objects in the computational domain [15–17].

The electrostatic solver is based on the same discretization framework and immersed boundary conditions are used to set the voltages at the applicator and target geometry [8,9]. The paint droplets are simulated as Lagrangian particles and their motion is given by the Basset-Boussinesq-Oseen (BBO) equation [18].

To speed-up the simulations a split is made between the near-bell region and the outer region, as seen in Figure 2. The underlying assumption is that the air flow and paint droplets in the near-bell region are not affected by the painted object. The near-bell simulation can therefore be performed offline with very high precision. The simulated air and droplet velocities, and droplet paths, at the cylindrical interface between the two regions, are then stored in a database. This database is later used as input for the online laydown simulations.

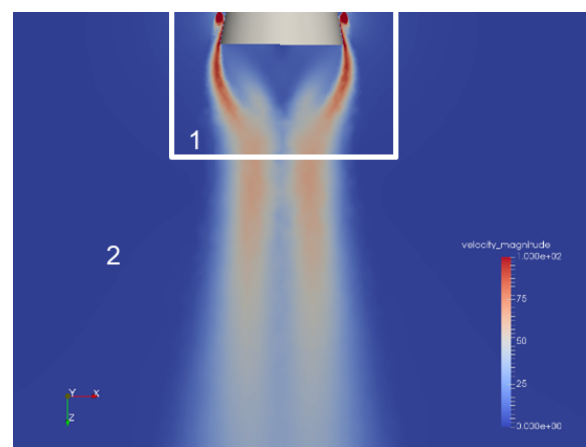

Fig. 2. The simulations are split in two regions. The near bell region (1) and the outer region (2).

Since the aim is to use the simulations for optimization of the robot path and process parameters the multiphysics simulation, despite being comparatively fast, needs to be combined with a projection-based method. In the projection method a stationary spray profile is generated based on the multiphysics simulations and paint thickness measurements on flat panels.

2.3. Path planning and optimization

Automatic path planning addresses the problem of finding collision free motions of moving objects. It is a well established research area and there are a number of distinguished groups in the world. Complete algorithms are of little industrial relevance due to the complexity of the problem. Instead, sampling-based techniques trading completeness for speed and simplicity are the methods of choice. Common for these meth-

ods are the needs for efficient collision detection, nearest neighbour searching, graph searching and graph representation. The two most popular methods are; probabilistic roadmap methods (PRM) and rapidly-exploring random trees (RRT). The PRM samples randomly among all configurations of an object, keeps the collision-free samples, and then connects those pairwise if the straight line path between them is collision-free [19]. The RRT incrementally builds two trees from the start and the goal configurations, respectively. In each step an attractor is generated at random and trees are expanded from the nearest node towards the attractor. The iteration stops when the trees overlap [20]. Inspired by both these probabilistic methods Fraunhofer-Chalmers Centre (FCC) has developed a deterministic path planner that adaptively adjusts a grid in the configuration space.

The optimization is initiated with a starting guess of the applicator path and then an iterative gradient-based procedure follows that utilizes a combination of projection and multiphysics simulations. Suitable rules for painting and acceleration limitations are taken into account. In the next step, a task planning is performed in which the IPS Path Planner is used to search for low cost robot motions. The cost associated with a motion is a weighted sum of penalties for execution time, joint motion, deviation from the optimized path, and small clearance. Finally, the brand specific robot code is transferred to the paint robot.

2.4. Spray painting technology

The coating line at Fraunhofer IPA is utilized to generate input conditions to the simulations and for validation of the simulated paint thickness with measurements. At the end of the project in early 2019 a demonstrator of the self-programming paint booth will be built-up at IPA in Stuttgart.

The input to the simulations include the paint droplet size distribution which is measured using a laser diffraction system, see Figure 3, and optionally also air and droplet velocities close to the bell cup that are measured using laser doppler anemometry (LDA) [21]. Furthermore, the electrostatic charge on the paint particles are estimated based on measurements of the current generated by the droplets on a target plate [22].



Fig. 3. Measurements of particle size distribution from an Electrostatic Rotary Bell Sprayer using a laser diffraction equipment.

2.5. Thickness measurement technology

The non-contact, thickness measuring system based on terahertz technology, developed by Fraunhofer ITWM, enables the measurement of single layers in multi-layer coatings with a repeatability of less than $1\mu\text{m}$ [12]. The flexible use of the robot-controlled measuring head for different applications e.g. for the measurement of complex 3D components, is among others guaranteed using a 20m long supply line, see Figure 4.

The thickness measurement technology, in addition to the final inspection on real components, also provides the layer thickness information for validating the simulated layer thickness distribution. As part of a measurement campaign at Fraunhofer IPA, around 50,000 measurements were carried out, in which the following coating systems were validated:

- Water-born paints,
- Solvent-born paints,
- Solid paints,
- Metallic paints.

The results showed that a very good agreement with well known magneto-inductive measurements could be achieved for all coating systems, see Figure 5 for an example. Furthermore, the terahertz technology offers the possibility of a contactless measurement of the layer thickness of the wet paint film.

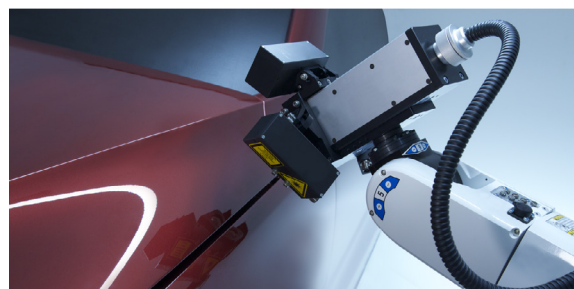

Fig. 4. Terahertz thickness measurement system with a sensor-controlled external measurement head.

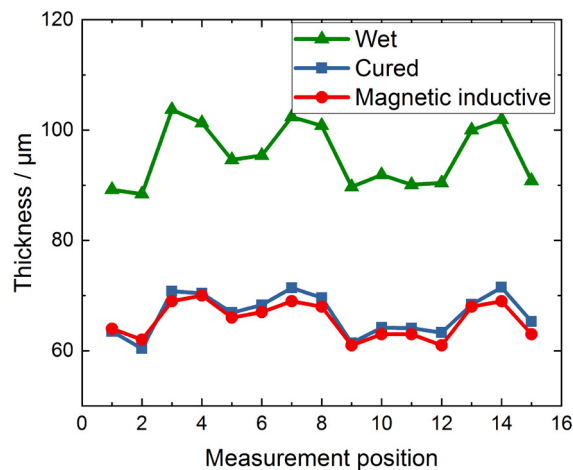

Fig. 5. Paint thicknesses measured with the terahertz technology at 15 different positions directly after painting (green) and after curing (blue). The corresponding standard magneto-inductive measurements (red) are included for comparison.

3. Results

To validate the approach of splitting the simulations in two regions according to Figure 2 a simple stroke across a flat plate was performed.

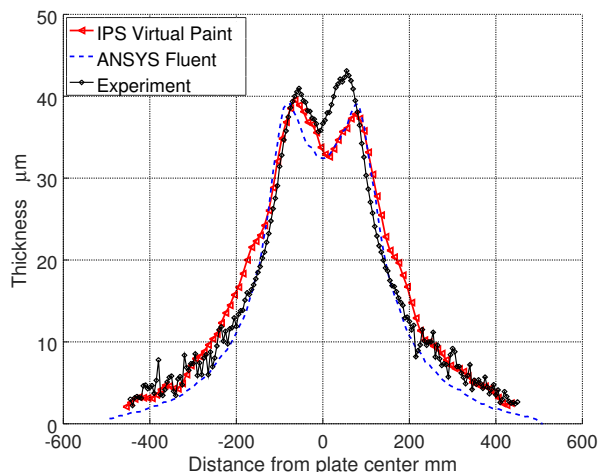

Fig. 6. A comparison of the resulting paint thickness on the panel for the multi-physics simulation in IPS Virtual Paint, simulations performed in Ansys Fluent, and measurements.

In Figure 6 the results obtained by IPS Virtual Paint are compared to Ansys Fluent results, and measurements. As can be seen in the figure there is a nice agreement and the IPS Virtual Paint results are obtained at a very small fraction of the computational cost required for performing the Ansys Fluent simulation. The next step was to validate the procedure and simulation accuracy on a realistic geometry. For this two fenders from John Deere that have been mounted on a rack (Figure 7), and painted using the simple robot path shown in Figure 8, were chosen. A snapshot from the simulation in IPS Virtual Paint is shown in Figure 9. Measurements were performed along several lines of the fenders as seen in Figure 10, and the positioning of the fenders were determined based on the 3D-scanning technology.

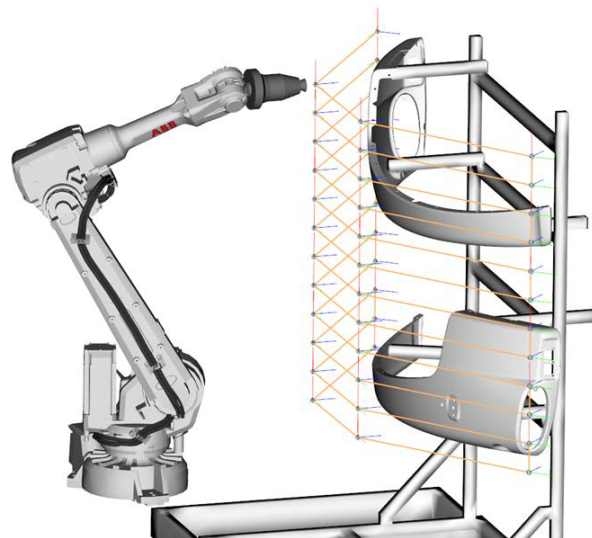

Fig. 8. A digital twin of the laboratory setup with two fenders on the rack was built-up in the IPS Virtual Paint software.



Fig. 9. A snapshot from the painting of the fender in IPS Virtual Paint.



Fig. 7. For validation of the procedure two fenders from the company John Deere were mounted on a rack and painted in the Fraunhofer IPA laboratory.

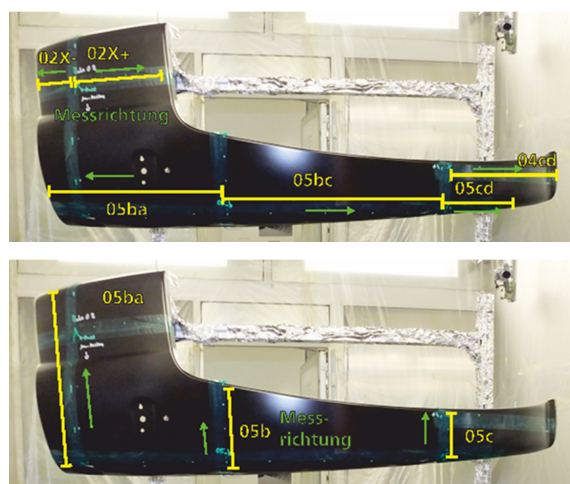

Fig. 10. The horizontal (top) and vertical (bottom) measurement lines on the upper fender.

In Figures 11 and 12 the simulated results are compared to the measurements. Overall the agreement is good with an average difference of estimated paint thickness around 10%.

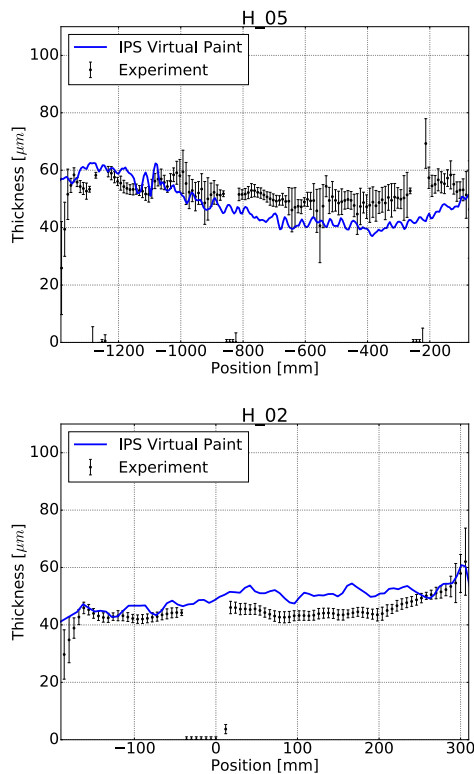

Fig. 11. A comparison between simulated and measured results along the horizontal lines of the upper fender.

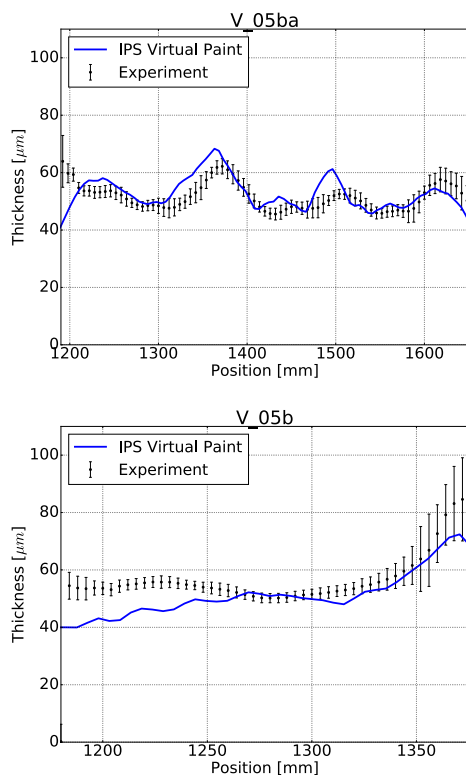

Fig. 12. A comparison between simulated and measured results along the vertical lines of the upper fender.

The gradient-based optimization approach was also applied to the painting of the fender. In Figure 13 the resulting paint thickness for the initial path is compared to an optimized path. A much more uniform paint thickness is obtained for the optimized path.

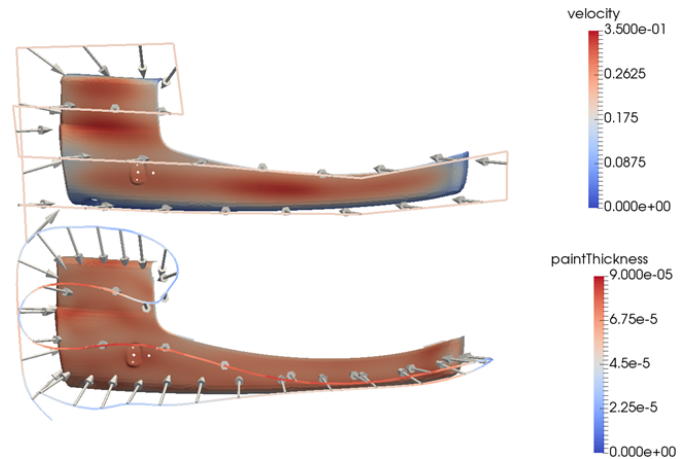

Fig. 13. A comparison of the paint thickness for the initial path (top) and optimized path (bottom).

4. Conclusions

In this paper the concept of a self-programming paint booth has been introduced. The basis is a fusion of state-of-the-art simulation technology, inline quality control by terahertz thickness measurements and surface treatment technology. The concept has been demonstrated for the painting of a tractor fender. Future work includes to fine tune the different technologies and establish robust interfaces to handle the data exchange between the modules. A physical prototype will also be built for demonstration purposes. The cloud based setup facilitates portability and further advantages of the procedure include a substantially shortened product preparation time, increased quality and reduced material and energy consumption. The automation of small product series will be facilitated and manual painting can therefore to a larger extent be replaced by robotized solutions.

Acknowledgement

The SelfPaint project is funded by the Fraunhofer Gesellschaft and the internal program for business oriented strategic alliances (WISA). The fender geometries were provided by John Deere in Bruchsal, Germany.

References

- [1] Achatz D. Aktuelle Strategien für eine umweltgerechte Lackierung am Beispiel Karosserie. Besser Lackieren Kongress 2014, Bad Nauheim, Germany.
- [2] Streitberger HJ, Dössel KF. Automotive Paints and Coatings. Weinheim:Wiley-VCH; 2008.
- [3] Ellwood KRJ, Braslaw J. A finite-element model for an electrostatic bell sprayer. J Electrostat 1998;45:1–23.
- [4] Im, KS, Lai, MC, Yu, STJ, Matheson Jr RR. Simulation of Spray Transfer Processes in Electrostatic Rotary Bell Sprayers. J Fluids Eng 2004;126:449–456.

- [5] Ye Q, Pulli K, Steinhilber T, Scheibe A. Numerical Simulation of Electrostatic Spray-Painting using Multiple High-Speed Rotary Bell Atomizers. In proceeding of EACC, 2007;335–343.
- [6] Mark A, Andersson B, Tafuri S, Engström K, Söröd H, Edelvik F, Carlson JS. Simulation of Electrostatic Rotary Bell Spray Painting in Automotive Paint Shops. *Atomiz Sprays* 2013;23:25–45.
- [7] Edelvik F, Mark A, Johnson T, Carlson JS. Math-Based Algorithms and Software for Virtual Product Realization Implemented in Automotive Paint Shops. In: Ghezzi L, Hömberg D, Landry Ch, editors. *Math for the Digital Factory*. Berlin: Springer-Verlag; 2017;231–251.
- [8] Johnson T, Jakobsson S, Wettervik B, Andersson B, Mark A, Edelvik F. A finite volume method for electrostatic three species negative corona discharge simulations with application to externally charged powder bells. *J Elstat* 2015;74:27–36. doi:10.1016/j.elstat.2014.12.009
- [9] Wettervik B, Johnson T, Jakobsson S, Mark A, Edelvik F. A Domain Decomposition Method for Three Species Modeling of Multi-Electrode Negative Corona Discharge – with Applications to Electrostatic Precipitators. *J Elstat* 2015;77:139–146. doi:10.1016/j.elstat.2015.08.004
- [10] Svensson M, Mark A, Edelvik F, Kressin J, Bohlin R, Segerdahl D, Carlson JS, Wahlborg PJ, Sundbäck M. Process Simulation and Automatic Path Planning of Adhesive Joining. In: *Procedia CIRP, 6th CIRP Conference on Assembly Technologies and Systems (CATS)*, 2016;44:298–303.
- [11] Mark A, Bohlin R, Segerdahl D, Edelvik F, Carlson JS. Optimisation of Robotised Sealing Stations in Paint Shops by Process Simulation and Automatic Path Planning. *Int J Manufact Res* 2014;9:4–26.
- [12] Krimi S, Klier J, Jonuscheit J, von Freymann G, Urbansky R, Beigang R. Highly accurate thickness measurement of multi-layered automotive paints using terahertz technology. *Applied Physics Letters*, 2016;109:021105.
- [13] www.iboflow.com
- [14] van Doormaal, JP, Raithby GD. Enhancements of the SIMPLE Method for Predicting Incompressible Fluid Flows. *Numer Heat Transfer* 1984;7:147.
- [15] Mark A, van Wachem BGM. Derivation and validation of a novel implicit second-order accurate immersed boundary method. *J of Comput Physics* 2008;227:6660–6680.
- [16] Mark A, Rundqvist R, Edelvik F. Comparison Between Different Immersed Boundary Conditions for Simulation of Complex Fluid Flows. *Fluid Dyn Mater Proc* 2011;7:241–258.
- [17] Mark A, Svenning E, Edelvik F. An Immersed Boundary Method for Simulation of Flow with Heat Transfer. *Int J of Heat and Mass Transfer* 2013;56:424–435.
- [18] Maxey MR, Riley JJ. Equation of motion for a small rigid sphere in a nonuniform flow. *Phys Fluids* 1983;26:883–889.
- [19] Bohlin, R, Kavradi, LE. Path planning using lazy PRM. In proceedings of IEEE Int Conf on Robotics and Automation, 2000;521–528.
- [20] LaValle, SM, Kuffner, JJ. Randomized Kinodynamic planning. In proceedings of IEEE Int Conf on Robotics and Automation, 1999;473–479.
- [21] Shen B, Ye Q, Tiedje O, Domnick J. Primary breakup of liquids using a high-speed rotary bell atomizer for spray painting processes. In proceedings of ILASS-Europe, 2017;355ff.
- [22] Güttler N, Paustian S, Ye Q, Tiedje O. Numerical and Experimental Investigations on rotary Bell Atomizers with predominant Air Flow Rates. In proceeding of ILASS-Europe, 2017;114ff.