



An updated cable feeder tool design for robotized stator cable winding

Downloaded from: <https://research.chalmers.se>, 2026-04-04 17:06 UTC

Citation for the original published paper (version of record):

Hultman, E., Leijon, M. (2018). An updated cable feeder tool design for robotized stator cable winding. *Mechatronics*, 49: 197-210. <http://dx.doi.org/10.1016/j.mechatronics.2018.01.006>

N.B. When citing this work, cite the original published paper.



An updated cable feeder tool design for robotized stator cable winding[☆]

Erik Hultman^{a,b,*}, Mats Leijon^{a,c}

^a Division for Electricity, Uppsala University, Box 534, 751 21 Uppsala, Sweden

^b Seabased Industry AB, Verkstadsgatan 4, 453 30 Lysekil, Sweden

^c Department of Electrical Engineering, Chalmers University of Technology, 412 96 Gothenburg, Sweden



ARTICLE INFO

Keywords:

Cable winding
Cable feeder tool
Robot automation
Stator assembly
Wave energy converter

ABSTRACT

We have previously suggested a method for robotized stator winding of cable wound electric machines and demonstrated the method successfully in full-scale experiments. The cable feeder tool used to handle the cable during the complete winding process is an essential component of this robot cell. To take the robot winding method to the next level, into an industrial product, require further developments regarding durability, independency, flexibility and implementability. In this paper, we present an updated cable feeder tool design. This tool is designed to be used in a robot cell for cable winding of the third-generation design of the Uppsala University Wave Energy Converter generator stator. In this work, three cable feeder tool prototypes have been constructed, experimentally evaluated and validated for the intended application. Key performance parameters are presented and discussed, including suggestions for further developments. We completed a durable, compact, high performance tool design, with fully integrated control into industrial robot controllers. The experimental results presented in this article are very promising and hence, the updated cable feeder tool design represents another important step towards an industrial solution for robotized stator cable winding.

1. Introduction

The use of cable winding has been suggested as a durable and efficient stator winding method for electric machines [1,2]. Automated stator winding technology is widely used, in particular for small and medium sized electric machines with high production volumes [3,4]. There are ongoing efforts to develop new automated stator winding methods providing higher machine efficiency, facilitated assembly and increased assembly flexibility [5–10]. However, being a less common winding technology used mainly for medium and large sized machines, cable winding has so far only been performed manually.

At UU,¹ cable winding is used in the generator of the UU WEC² concept [11]. This concept has now reached the third design generation, see Fig. 1a, and is commercialized by the spin-off company Seabased Industry AB. In the full-scale project, multiple WECs are to be deployed together in farms, to achieve a scalable system and to smoothen the fluctuating power output from single devices [12]. Consequently, numerous stators will need to be assembled for these WECs. The stator currently used in the WEC generator is about 2 m long, divided into six or nine separate sections and wound with a 25 mm² PVC-

insulated multi-thread installation cable, see Fig. 1b. During manual winding of the stator, the winding cable is pulled back and forth through slot holes in the stator, a very repetitive and exhausting task. About 3000 m of cable is used in each UU WEC generator, so the assembly is very time-consuming.

We have previously developed and evaluated a cable feeder tool for robotized cable winding of the second generation design of the UU WEC with very promising results [13], see Fig. 2a. Inspired by this robot tool, a simplified manual cable feeder tool has been developed and tested in production at Seabased Industry AB, see Fig. 2b. Manual cable feeder tools have been used before during cable winding of other larger machines [14]. Likewise, commercially available cable feeder machines are often used to assist cable pulling winches when laying cable. These machines regularly use hydraulic or electric driven belts to feed cable. When installing cables in closed ducts, such cable feeder machines are often used with cable blowing or cable floating technology [15–19]. Here, either compressed air or water is forced through the duct with the cable, sometimes combined with cable lubrication. The robotized stator cable winding process does have some conceptual similarities to robotized filament winding developed for the manufacturing of fiber

[☆] This paper was recommended for publication by Associate Editor Prof. Cesare Fantuzzi.

* Corresponding author at: Division for Electricity, Uppsala University, Box 534, 751 21 Uppsala, Sweden.

E-mail address: erik.hultman@angstrom.uu.se (E. Hultman).

¹ Uppsala University.

² Wave Energy Converter.

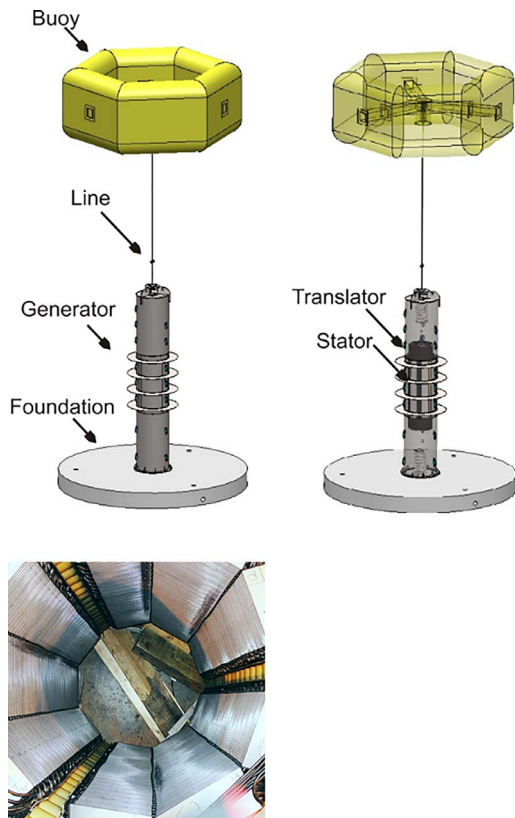

Fig. 1. (a) The third generation UU WEC unit: a linear direct-drive generator, placed on the seabed, coupled via a line to a point-absorbing buoy. (b) A nine-sided cable wound stator inside the UU WEC generator hull during assembly.

reinforced composite materials [20,21] and winding machines developed for the manufacturing of superconductive coils [22]. Simplified, such equipment can be described as an unwinding reel, a moving pay-out tool and a moving winding table or mandrel where the cable or fiber is laid.

One of the main challenges in automating stator cable winding is the flexible nature of the winding cable. Methods and sensors for localization, manipulation, shape prediction and automatic routing of flexible objects, including loose cables, have previously been demonstrated in similar applications [23–28]. It is important to avoid cable twisting during the cable winding application. If not, self-contacting cable loops might form due to torsional forces on the cable. If winding cables with helical multi-thread conductors are used, such loops might form due to varying cable tensional forces during the winding procedure. If these loops does not pop-out easily when the cable is tensed the cable can be damaged, a phenomena well described in the literature and referred to as hockling [29–32]. For a created cable loop to pop-out, axial tension must be applied to the cable. Knowing the mechanical properties of the cable, the axial cable tension required to pull out a loop without kinking and the cable curvature at pop-out can be described as a function of the axial cable torque. Cable kinking is more likely with torsional-stiff cables that are easy to bend.

The development and adaption of the UU robotized stator cable winding concept for the third generation of the UU WEC generator—with the ambition to become an industrial product—requires an updated cable feeder tool design. The cable feeder tool can be described as the heart of the cable winding solution, being the equipment used by the industrial robots to handle the cable during the complete winding process. Furthermore, a simplified cable feeder tool is also used in robotized cable winding to feed cable from a cable drum to the robots [33] and similar cable feeder tools have been suggested to be used for temporary cable storage during the winding process [34]. The present

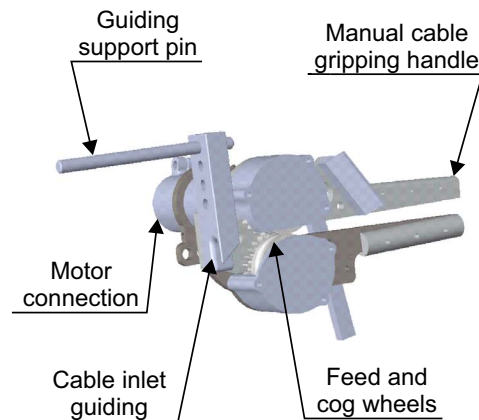
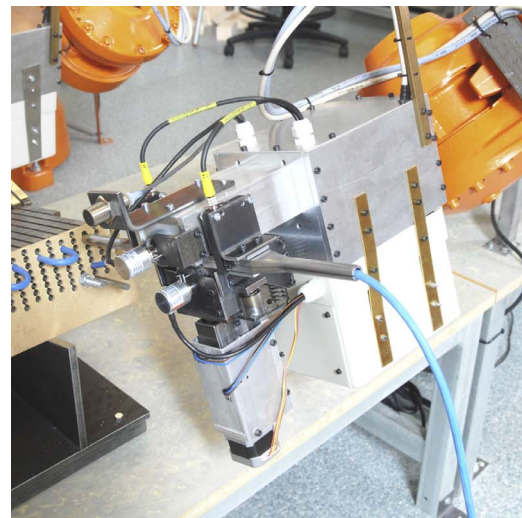

Fig. 2. (a) The cable feeder tool previously used for robotized stator cable winding experiments at UU. (b) A 3D-CAD model of the manual cable feeder tool previously used at Seabased Industry AB to facilitate manual stator cable winding.

development of the robotized stator winding solution put some specific requirements on the cable feeder tool, which could not be completely satisfied by the previously developed robot cable feeder tool. These requirements include controllability, process supervision, durability, higher feed performance and adaptions for the new UU WEC design. For example, faster tool operations, higher feed forces and velocities, more precise feed lengths, more reliable cable dropping and more flexibility in choosing feed parameters are needed. We considered the feed mechanisms used in the Seabased manual cable feeder tool and in commercial cable feeder tools for the new tool. However, these tools lack many of the other functions needed for robotized stator cable winding, including controllability, process supervision and cable handling capabilities. Cable feeder machines used during cable laying cannot be used for our stator cable winding application, as these require closed and long cable ducts. Lubrication of the cable or the stator slots is not recommended either, since this would considerably reduce the friction between the cable and the feed mechanism of the cable feeder tool, thus reducing the feed force that could be transferred to the cable. Neither the equipment used for automated assembly of other stator winding concepts, the equipment for robotized filament winding nor the equipment for superconductive coil winding can be used to feed cable in our application. Therefore, we needed an updated cable feeder tool.

The aim of this paper is to present and validate a durable and high

performance updated version of the cable feeder tool used for the robotized stator cable winding of the UU WEC generator stator, including the mechanical design, the control system design, the experimental evaluation and the validation. The intended integration of the presented equipment into a complete robotized cable winding process is not covered. Section 2 presents the experimental setup and the methods used for developing and evaluating the cable feeder tool. Section 3 presents the final updated tool design and Section 4 presents the experimental results. These results are discussed in Section 5 and finally conclusions are given in Section 6.

2. Experimental setup and methods

In the presented work, three cable feeder tool prototypes were designed, constructed, calibrated and validated. The design was first validated in a 3D-CAD environment. An ABB AC500 PLC³ was used to control and supervise the tools. To facilitate implementation of the cable feeder tool in the intended robotized cable winding application, the control system was fully integrated into the controllers of the industrial robots. The complete equipment was assembled, programmed and tested in-house. Designing the cable feeder tool was an extensive process, where multiple technical challenges needed to be solved in parallel. However, for clarity, the solutions to these challenges are here presented separately. Programming the control system was an iterative process, requiring numerous adjustments, calibrations and improvements, before a durable and satisfying solution was found.

During the development and validation of the cable feeder tools, a robotized cable winding experimental setup at UU was used. This setup included the PLC, two ABB IRB4400/60 kg M2000 S4C+ industrial robots, a shortened UU WEC stator section, winding cable and a combined cable drum feeding and cable cutting equipment [33], see Fig. 3. In the experiments, relevant equipment parameters, such as cable feed velocities, cable feed forces and positioning velocities of the robots, were logged by the PLC.

We used a robot cable feeder tool to grip a winding cable with different gripping forces to evaluate the accuracy of the developed cable gripping force supervision. The actual gripping force was then determined by manually measuring the compression of the gripping force damping power springs and was compared to the supervised value of the cable gripping force. To evaluate the accuracy of the actual gripping force in relation to the desired gripping force, we again used a robot cable feeder tool to grip a cable with different forces. About 1 s after the grip operation was finished, we took a 3 s average value of the supervised gripping force. The same procedure was then repeated for a gripping force adjustment operation.

To calibrate and to evaluate the accuracy of the cable feed distance supervision, a robot cable feeder tool was used to feed 10 m free cable back and forth through the tool with different velocities. The actual feed distance was then decided by manually measuring the length of cable which had been fed and compared to the supervised cable feed distance value and to the desired cable feed distance.

The experimental setup shown in Fig. 4a was used to calibrate and to evaluate the accuracy of the developed cable feed force supervision. Here, different well-defined gravity masses were attached to a cable and pulled upwards by a robot cable feeder tool with different velocities and different cable gripping forces while an average value of the supervised feed force was taken during feeding with constant velocity. The idle feed force supervision was further calibrated by feeding free cable through the tool with different velocities and different cable gripping forces.

We used the experimental setup shown in Fig. 4b to evaluate the cable feed slip supervision. Here, a winding cable was attached to a retracting tension spring and the spring was in turn fixed to a steady

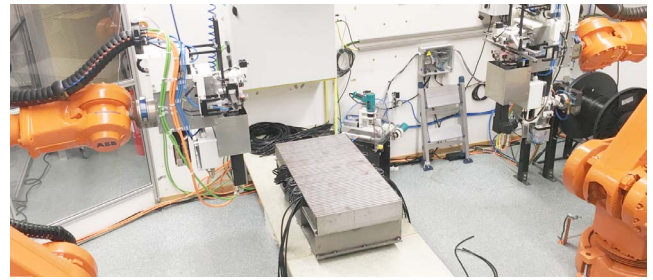

Fig. 3. The complete robot cell used during the experiments, with the shortened UU WEC stator section, the constructed robot cable feeder tools mounted on the industrial robots and the constructed drum cable feeder tool mounted with the drum feeding and the cable cutting equipment.

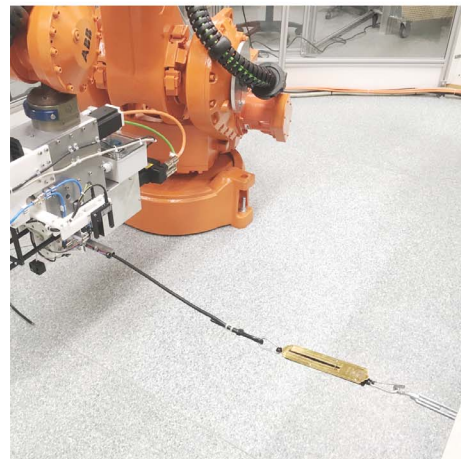
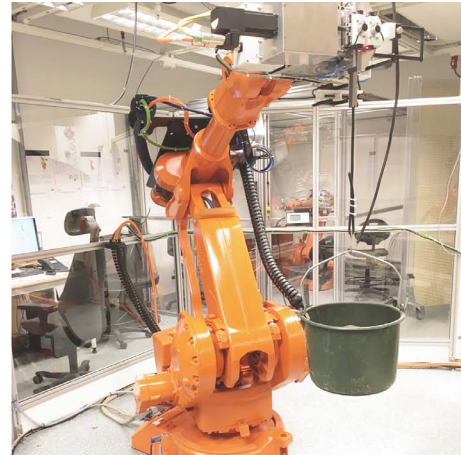

Fig. 4. (a) The experimental setup used to evaluate the accuracy of the cable feeder tool feed force supervision. (b) The experimental setup used to evaluate the cable feeder tool feed slip supervision.

table. As the cable was pulled by a robot cable feeder tool, the spring stretched and the cable feed force increased until the feed slip supervision was triggered and the feeding stopped.

3. Cable feeder tool design

When designing the cable feeder tool, we used the previous tool [13] as starting point. However, the complete design was re-evaluated and other similar tools, winding strategies and applications were studied [3–10,14–22]. For example, with the promising results from the previous tool in mind, we chose the double feed wheels feed mechanism used in the Seabased manual cable feeder tool rather than the belt feed

³ Programmable Logic Controller.

mechanism used in commercial cable feeder tools. This set-up reduces the required cable gripping force compared to the previous single feed wheel design while keeping down the tool dimensions. In the design process, we gave ample attention to the results and experiences from previous work on robotized cable winding, but also took into account the experience from manual winding. For example, the previous robot cable winding procedure [13], where the cable was always held by a cable feeder tool and fully guided when fed through the stator section and between the tools, was re-utilized. Hence, cable localizing was limited to detecting the cable end inside the cable feeder tool, to measure the fed cable distance and to supervise cable drops. With this winding procedure, the cable in the end windings is not tensed as the end windings are pulled. Furthermore, the intended winding application requires the use of cables that are easy to bend to small radii as the cable is pulled between near slot holes. Hence, self-contacting cable loops formed on the cable during winding are unlikely to pop-out easily and focus must be on preventing the cable to twist in the first place. Therefore, we designed the robot cable feeder tools to be facing downwards during winding, thus preventing undesired cable twisting when moving the cable from one slot hole to another, as demonstrated in [13]. We considered the changes introduced to the stator of the third generation UU WEC as well. The changes influencing the cable feeder design the most were the change from a 16 mm² to a 25 mm² winding cable and the change from angled to straight stator sections.

The requirements that the new cable feeder tool should fulfill are summarized in Table 1. Two identical but mirrored tool prototypes were designed and constructed, in accordance with these requirements, to be used by two robots performing winding together. A simplified version of the tool was also constructed, to be used for delivering cable from a cable drum to the robots.

In the rest of this section, the final mechanical design of the cable feeder tool is presented in Section 3.1 and the final version of the control system is presented in Section 3.2.

3.1. Mechanical design

When designing the new tools, we aimed to dimension the tools so they would be able to handle the expected process forces for the duration of their life-time, while trying to keep the tool dimensions as small as possible. Durable, standard industrial motors, motor drives, actuators, transmissions, cabling and sensors were used as far as possible. Some more complex tool components were custom made, such as

Table 1
Requirements for the updated cable feeder tool, including priority where A are the most critical and C are the least critical.

Requirement	Priority
Designed for robotized stator cable winding	A
Adapted for the winding of the third generation UU WEC stator	A
Fully controlled by the PLC	A
Full control provided to the robot controllers	A
Able to catch, feed, direct and drop the cable	A
Able to push down end windings	A
Supervised cable feed force of up to 400 N or higher	A
Adjustable cable feed velocity of up to 1.2 m/s or higher	A
Adjustable, supervised and sufficient cable gripping force	A
Able to synchronize feeding with other tools and with robots	A
High precision supervision of cable fed distance	A
Reliable and fast detection of cable feed slip	A
Reliable supervision of cable dropping	A
Reliable and precise positioning relative to the stator	A
Durable performance	A
Minimal cable wear	A
Fast adjustments of tool mechanisms	A
Minimal tool wear	B
Easy to maintain	B
Simple and inexpensive	B
Scalable design	C

the feed wheels and the cable guiding system, or adjusted, such as the cog wheels. To limit the complexity and the investment cost, most of the tool frames and housings were screwed together from flat, machined parts. The majority were custom-made in high-strength aluminum in an external mechanical workshop, while parts with lower accuracy and strength requirements were custom-made in POM-H plastic in-house. To minimize cable wear, micro energy chains were used to guide moving cabling inside the tools. An energy chain dress pack with integrated pull-back was used to guide cables and pneumatic hoses on the robot arm. We constructed a service and storage frame, where the tool could be stored when unmounted from the robot. The final robot cable feeder tool design is explained in Fig. 5, while Fig. 6a shows a photo of the final mounted robot cable feeder tool and Fig. 6b shows a photo of the final constructed drum cable feeder tool.

In the rest of this section, the robot cable feeder tool design is further explained in Sections 3.1.1–3.1.4, while Section 3.1.5 explains the differences in the drum cable feeder tool design.

3.1.1. Feeding the cable

The most essential task for the cable feeder tool is to feed the cable in a durable way with a high feed force and precision. We used a geared brushless AC servo motor, nominally rated at about 2.1 N m at about 3000 rpm and geared 5:1, to drive the cable feed mechanism. We also designed a new feeding wheel, adapted to the new cable dimension. The wheel was made from high-strength aluminum, with a concave grooved and sand-blasted feed surface and a feed diameter of about 44 mm. The theoretical nominal tool cable feed force was just over 450 N at just under 1.4 m/s cable feed velocity, including the characteristics of the applied gear and servo motor drive but neglecting the mechanical losses in the gear and the bearings as well as the force required to feed the cable between the wheels while being squeezed. The corresponding peak feed force was close to 800 N at just under 1.1 m/s. To reduce the required cable gripping force, double feed wheels, directly coupled to each other with cog wheels, were used. Hence, the feed wheel contact surface with the cable was doubled and the gripping force could, theoretically, be halved compared to feeding with one wheel. The distance between the cog wheels depended on the cable gripping force and cable gripping deformation, which varied slightly during feeding. Consequently, the cog wheels did not fit perfectly radially and the cogs were expected to be subjected to more wear than in a normal application. The aluminum feed wheels were also expected to be subject to wear, although the wear was likely to be less than in the previous rubber surface feed wheel design. Therefore, to simplify maintenance and replacement, the feed wheels and the cogs were mounted together on hub-shaft connections, see Fig. 7a.

Previous experience showed that supervising the feed wheel rotation was not sufficient to get an accurate value of the cable fed distance. Moreover, the previous cable feed slip supervision could not be implemented for the double feed wheel design. Therefore, a separate miniature cable fed distance measuring system was designed and mounted on the feeding side of the cable guiding system, close to the feed wheels. Here, a measuring wheel with a sand-blasted contact surface was pushed by two small power springs against the cable through an oblong hole in the cable guiding system. The measuring wheel was in turn connected to an incremental rotational sensor, see Fig. 7b. This custom-made measuring system was much smaller than commercially available cable length measuring machines and smaller than commercially available measuring wheel systems.

3.1.2. Gripping the cable

To be able to feed cable efficiently through the stator section during winding requires high cable gripping forces as well as quick and precise adjustment and supervision of the cable gripping force and the position of the lower feed wheel. To achieve this, a brushless AC servo motor, nominally rated at about 1.4 N m at about 4000 rpm, was directly coupled to a ball screw unit where the nut was connected to the lower feed

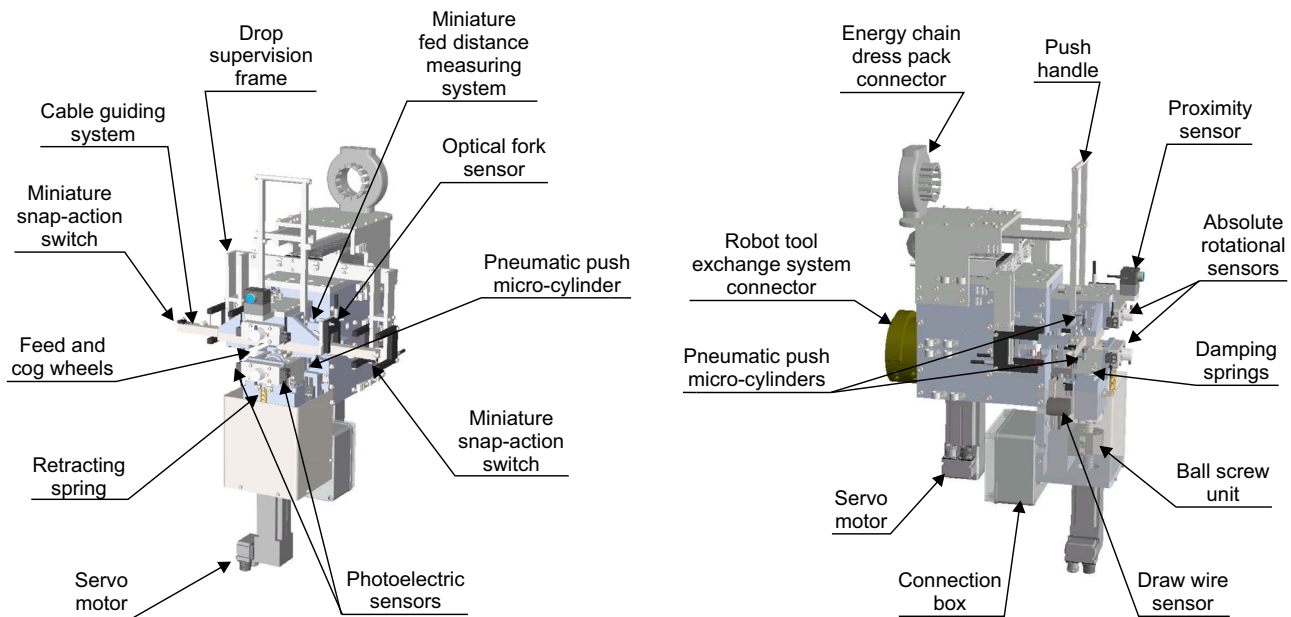

Fig. 5. A 3D-CAD model explaining the most essential parts of the updated robot cable feeder tool design.

wheel with two damping power springs and one retracting tension spring, see Fig. 8a. As with the previous design, the ball screw nut and the lower feed wheel were mounted separately on a miniature linear guiding system. The function of the power springs was to ramp the gripping force and to compensate for small variations in the cable diameter, while the function of the tension spring was to ensure contact between the two units. Thus, including the characteristics of the ball screw unit and the servo motor drive but neglecting the mechanical losses in the ball screw unit and the bearing, the theoretical nominal cable gripping force was about 1700 N at a linear wheel positioning velocity of about 20 m/s. To supervise the position of the lower feed wheel, two miniature snap-action switches were used to define its stroke and an analogue draw wire sensor was used to supervise its actual position. Furthermore, analogue absolute rotational sensors were mounted on the cog wheels axes to supervise their actual angular positions and to enable the cog wheels' angular fitting evaluation, see Fig. 8b.

3.1.3. Handling the cable

A rigid cable guiding system, able to catch, guide, direct and drop the cable, is essential to perform durable stator cable winding with the cable feeder tool. Therefore, we decided to use a split pipe design, similar to, but stiffer and more precise than the one in the previous tool, to handle the cable. Here, the lower part of the cable guiding system was coupled directly to and controlled by a double-acting guided linear pneumatic cylinder, equipped with two Hall Effect sensors supervising its position, while the upper part was mounted on the tool housing with strong brackets. An optical fork sensor was mounted over a miniature hole on the feeding side of the cable guiding system and used to detect the cable inside the cable guiding system, see Fig. 9a. As before, the cable was dropped by opening the feed wheels and the cable guiding system with the tool facing downwards. To ensure that the cable was dropped, we used three pneumatic push micro-cylinders with spring return to push the cable out of the cable guiding system, see Fig. 9b. The cable was dropped through two through-beam photoelectric sensors and four optical fork sensors. The photoelectric sensors were fixed mounted close to the feed wheel, while the optical fork sensors were mounted on a frame which could be pushed over the cable guiding system. The frame positioning was performed by a double-acting guided linear pneumatic cylinder, equipped with two Hall Effect sensors supervising its position. Hence, the fork sensors could be retracted during winding and pushed out only when the cable was dropped, see Fig. 9c and d.

Furthermore, as the winding cable is pulled through a slot hole during the winding process, an end winding loop is created on the opposite stator section side. If an overlapping winding pattern is used, these end windings build on top of each other and could block the next slot hole to be wound. To avoid this, the end windings need to be pushed down after a cable has been wound. A push handle was added to the tool to address this problem. The top of the push handle was rounded and about 100 mm wide. The push handle could also be used to manually lift the cable feeder tool when unmounted from the robot.

3.1.4. Positioning relative to the stator section

Precise positioning of the cable feeder tool against and relative to the stator section is essential. Therefore, a cylindrical shielded proximity sensor was mounted on the tool and used to take measurements on the stator section during a similar positional calibration procedure as the one developed for the previous tool [35]. To achieve a more accurate positioning against the uneven stator side, miniature snap-action switches were mounted on the receiving and feeding ends of the cable guiding system, see Fig. 10a.

To facilitate positioning, five different TCPs⁴ were defined on the cable feeder tool according to its intended use: one in the middle between the closed feed wheels, one on each end of the cable guiding system ends, one at the detecting distance centered in front of the proximity sensor and one on top of the push handle, see Fig. 10b.

3.1.5. The drum cable feeder tool

Some of the functions of the robot cable feeder tool were not required for the drum cable feeder tool, allowing a somewhat simplified design. To begin with, lower feed force requirements allowed direct feed wheel drive with the same servo motor, eliminating the gear. Thus, including the characteristics of the servo motor drive but neglecting the mechanical losses in the bearings as well as the force required to feed the cable between the wheels while being squeezed, the theoretical nominal drum tool cable feed force was just under 100 N with high cable feed velocities. The corresponding peak feed force was just above 150 N with high velocities. Lower cable feed forces, which demanded lower cable gripping forces, in combination with lower requirements on precision and flexibility, meant that a simpler double-acting guided linear pneumatic

⁴ Tool Centre Point.

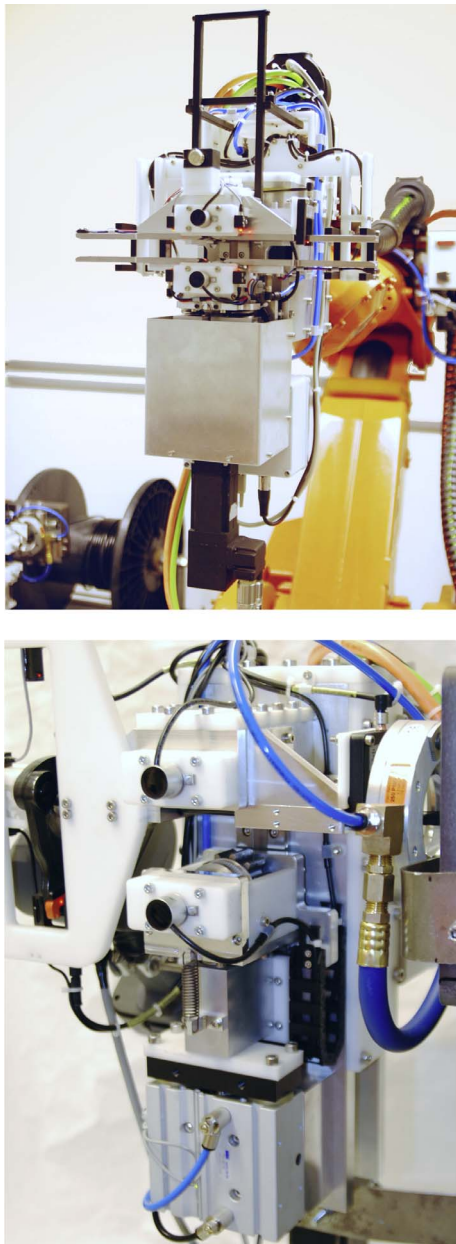

Fig. 6. (a) One of the two constructed robot cable feeder tool prototypes. (b) The constructed drum cable feeder tool prototype.

cylinder could be used to control the position of the lower feed wheel in the drum cable feeder tool. Moreover, only one power damping spring was needed. The pneumatic cylinder was equipped with two Hall Effect sensors supervising its position. As a result, neither the miniature snap-action limit switches nor the analogue draw wire sensor were needed in the drum feeder tool. Since the drum feeder tool was fixed mounted and did not need to drop the cable, the cable guiding system could be shortened and did not need to be opened. Neither the cable drop equipment, nor the push handle nor the positional calibration measuring sensors were needed. However, an additional optical fork sensor, mounted on the cable guiding system at the receiving side of the feed wheels, was used to detect if the cable drum ran out of cable.

3.2. Control system design

Full control of the cable feeder tools in the PLC was achieved by connecting all sensors and the pneumatic solenoid valves controlling

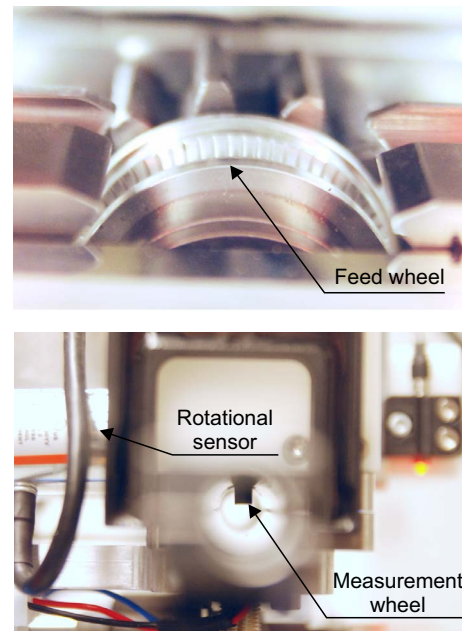

Fig. 7. (a) A feed wheel mounted with a cog wheel inside a robot cable feeder tool. (b) The measuring wheel of the miniature cable fed distance measuring system, as seen from the cable guiding system end of a robot cable feeder tool.

the pneumatic cylinders directly to the PLC main unit, through point-to-point connections to digital and analogue IO expansion modules. The servo motor drives and the robot controllers were also connected to the PLC main unit, through EtherCAT and Profibus DP fieldbus communication to specific expansion modules. The ABB Motion Control Library was used to enable full control and supervision of the motors in the PLC. The physical layout of the control system communication is explained in Fig. 11.

In the PLC control system, separate sub-programs were used to control and supervise the cable feeder tools. Different supervision sub-programs were used and continuously cycled to supervise the tools. Here, diverse sensor values were interpreted and compared to each other and to pre-defined or operation-specific threshold values. Detection of non-fatal, well defined failures were designed to enable automatic process recovery. For example, a cable drop failure could trigger the push cylinders mounted on the cable guiding system to oscillate in order to loosen a cable being stuck. Fatal failures with unclear causes on the other hand, such as an unexpected high feed force, should normally not occur and was therefore not responded to with automatic failure recovering. We put a lot of work into preventing possible failures, which could damage the tools or the winding process, into making the control system durable and into enabling flexible and detailed control of the tool. To enable full control over the cable feeder tools in the robot controllers—which would facilitate implementation in stator cable winding—we developed separate, tool operation specific, sub-procedures and integrated these into the robot controllers control systems. This integration included triggering different tool operations according to desired parameters and communicating the tool status.

In the rest of this section, the PLC control system is further explained in Sections 3.2.1–3.2.6, while Section 3.2.7 explain differences in the drum cable feeder tool PLC control system.

3.2.1. Cable gripping supervision

To achieve a reliable supervision of the position of the lower feed wheel, the analogue output from the draw wire sensor was gently filtered in the PLC and translated into the distance between the two feed wheels. Three feed wheel distance intervals were defined within the positional stroke of the wheel: opened, half-opened and closed. The open position corresponded to the feed wheels being completely

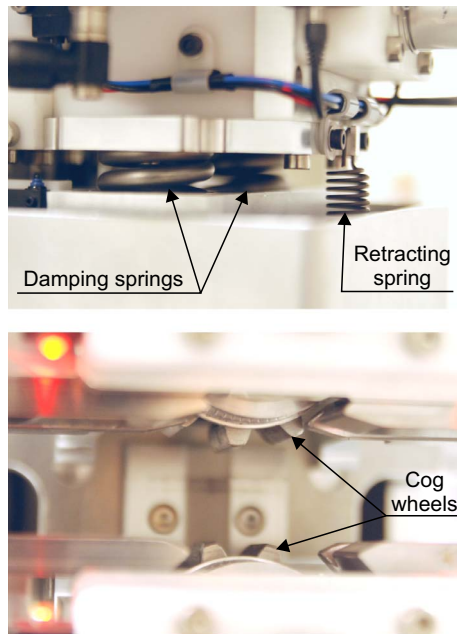

Fig. 8. (a) The damping power springs and the retracting tension spring mounted between the lower feed wheel and the ball screw nut inside the robot cable feeder tool. (b) The two cog wheels, mounted inside a robot cable feeder tool, being fitted angularly to each other.

opened, thus allowing the cable guiding system to be opened and the cable to be dropped from the tool. The half-open position corresponded to the feed wheels being slightly opened, thus allowing cable to be fed between the wheels while assuring that the cable was guided into the feeding side of the cable guiding system. The close position corresponded to the feed wheels being closed, thus gripping the cable and enabling the tool to feed cable. The cable feed wheels' distance supervision was also used to define service intervals for the ball screw unit, by counting the total number of strokes for the ball screw unit.

A reliable supervision of the cable gripping force was also required. This was achieved by supervising the compression length of the power springs mounted between the ball screw nut and the lower feed wheel. The supervision was performed by comparing the supervised position of the lower feed wheel to the position of ball screw nut, which was calculated from the gripping motor position provided by the servo motor drive. Knowing the power springs deflection to force ratio, the spring compression length was in turn translated into a cable gripping force. Furthermore, during feeding, the supervised cable gripping force was compared to the expected force. If the supervised force deviated too much from the expected force, an error was raised in the PLC and the feed process was immediately stopped.

To supervise the cog wheels' angular fitting, the analogue outputs from the two absolute rotational sensors were gently filtered in the PLC and translated to cog wheel rotations. These rotations were in turn compared to each other. Knowing the relative rotational mounting offset and the number of cogs, the angular fitting of the two cog wheels could thus be evaluated.

3.2.2. Cable feed supervision

A reliable supervision of the cable fed distance was achieved by counting the pulses from the incremental rotational sensor in the miniature feed distance measuring system in the PLC and translating the result into cable fed distance in 0.9 mm steps. This value was in turn translated into cable velocity. Calibration of the cable feed system and the cable fed distance supervision was performed using the method presented in Section 2. The cable fed distance supervision was also used to define service intervals for the feed wheels and the cog wheels, by counting the total absolute cable fed distance for the wheels.

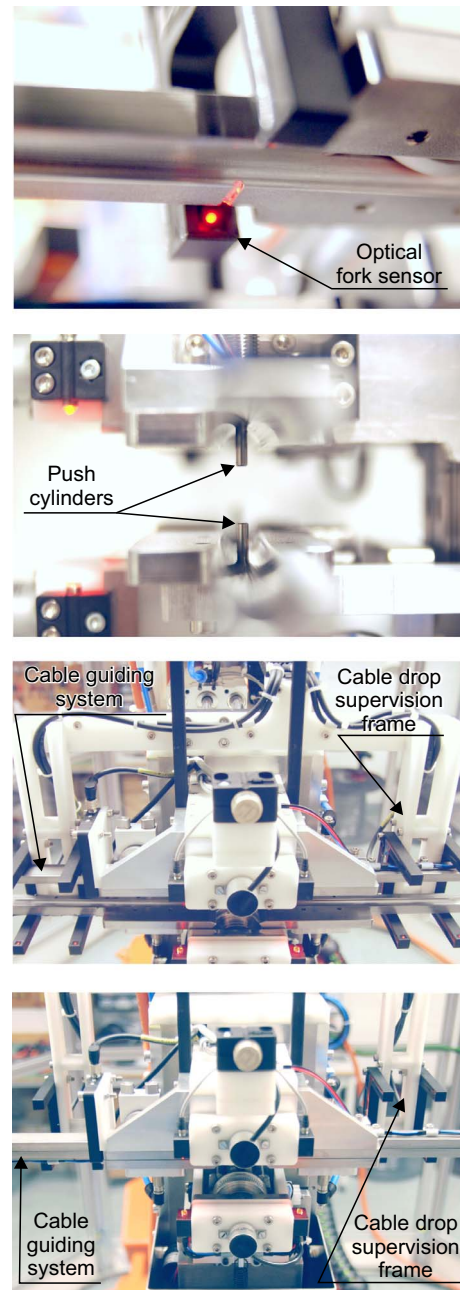

Fig. 9. (a) The optical fork sensor used to detect cable inside the guiding system of a robot cable feeder tool. (b) The micro pneumatic push cylinders pushed out, as seen from the cable guiding system end of a robot cable feeder tool. (c) The cable drop supervision frame pushed out over the cable guiding system of a robot cable feeder tool. (d) The cable drop supervision frame retracted from the cable guiding system of a robot cable feeder tool.

To achieve a reliable supervision of the feed force transferred to the cable, the idle feed force needed to be calculated and subtracted from the supervised feed motor force. The total feed motor force was calculated by gently filtering the motor current provided by the servo motor drive and knowing the servo motor torque constant. The idle feed force, on the other hand, was observed to be varying largely mainly with the cable gripping force and feed velocity. Calibration of the feed force supervision, including deciding these dependencies, was performed using the method presented in Section 2. During feeding, the supervised cable feed force was compared to the expected maximum required feed force for the current operation. If a higher force than expected was registered, an error was raised in the PLC and the feed

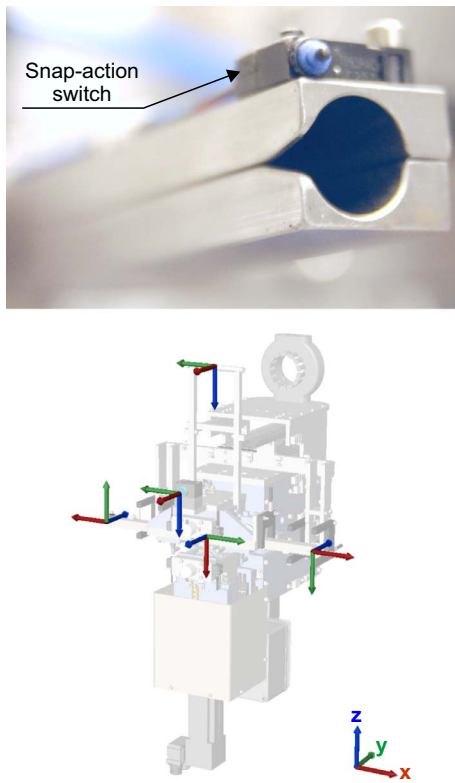

Fig. 10. (a) One of the miniature snap-action switches mounted on the end of the cable guiding system of a robot cable feeder tool. (b) A 3D-CAD model showing the placement of the five TCPs on a robot cable feeder tool.

process was immediately stopped. The force limit was defined at the beginning of a cable feed operation and could thus be chosen depending on the current feed operation.

To reliably supervise cable feed slip, the cable feed force was compared to the cable gripping force during feeding. If the gripping force to feed force ratio, expressed as a force slip coefficient, decreased to less than 150%, an error was raised in the PLC and the feed process was immediately stopped. This supervision method was intended to react before feed slip occurred, to protect the tool, the cable and the winding process. However, under certain circumstances, if the cable did get stuck momentarily during feeding at high velocities, this supervision might not be fast enough to register the peak feed force occurring as slipping started. Therefore, a second feed slip supervision was required as backup. Here, the cable velocity was compared to the feed wheels' velocity. If the difference between these two values, expressed as a velocity slip coefficient, was larger than 75% of the feed wheels' velocity for longer than 0.5 s an error was raised in the PLC and the feed process was immediately stopped. Since this supervision method was used as backup, it was calibrated to low sensitivity.

3.2.3. Cable drop supervision

To achieve a reliable cable drop supervision, the optical fork cable presence sensor was supervised together with the dedicated through-beam photoelectric and optical fork sensors while a cable was dropped. For a cable drop to be verified, the optical fork sensor needed to be deactivated exactly once and never activated. All other supervised sensors needed to be activated exactly once and deactivated exactly once during the supervision. If any of the sensors were activated or deactivated more than allowed, the drop supervision failed.

3.2.4. Cable gripping functions

To enable a flexible lower feed wheel positioning, five different required cable gripping functions were identified:

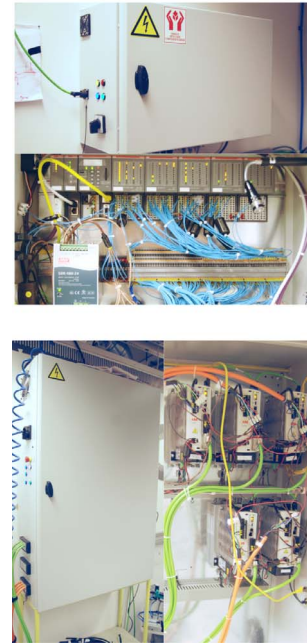
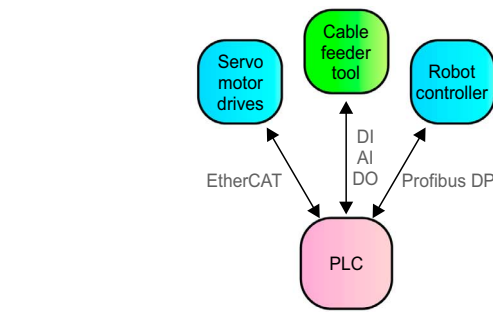

Fig. 11. (a) The control system communication layout for a cable feeder tool. (b) The outside (top) and inside (bottom) of the PLC cabinet. (c) The outside (left) and inside (right) of the servo motor drives cabinet.

1. Homing action of the ball screw nut
2. Opening the feed wheels
3. Half-opening the feed wheels
4. Gripping the cable
5. Adjusting the cable gripping force

The gripping functions were integrated separately in the PLC control system: (1) In the ball screw nut homing function, the balls screw nut was lowered to the lower miniature snap-action limit switch. The servo motor drive position was then reset before the feed wheels were opened. (2) In the open function, the ball screw nut was repositioned according the predefined open position. (3) In the half-open function, the ball screw nut was repositioned according to the predefined half-open position. (4) When initiating the gripping function, the actual cog wheel angular fitting was evaluated automatically and adjusted if needed. Next, the ball screw nut was positioned according the predefined close position—corresponding to the feed wheels being closed with a negligible cable gripping force—and finally the ball screw nut was moved upwards until the cable gripping force reached the desired value. (5) In the gripping force adjustment function, the deviation between the actual cable gripping force and the desired cable gripping force was used to calculate the theoretical required ball screw nut re-positioning and the ball screw nut position was adjusted accordingly.

3.2.5. Cable feed functions

Eight different cable feed functions were identified to be required

for flexible cable feeding:

1. Jog feed
2. Feeding a relative distance
3. Feeding an absolute distance
4. Feed to force
5. Feed synchronized to another cable feeder tool
6. Feed synchronized to a robot movement
7. Find and adjust to the position of the cable end
8. Fit the cog wheels angularly

These feed functions were also integrated separately in the PLC control system: (1) In the jog feed function, cable feeding was performed according to the specified direction, velocity and acceleration, until interrupted. (2) In the feeding a relative distance function, cable feeding was performed according to the specified direction, velocity, acceleration and relative feed wheels' cable feed distance. (3) In the feeding an absolute distance function, cable feeding was performed according to the specified velocity, acceleration and absolute feed distance. Here, the specified absolute feed distance was translated to a relative feed wheels' feed distance, by comparing the actual value of the supervised cable fed distance to the specified desired absolute cable feed distance. (4) In the feed to force function, cable feeding was performed according to the specified direction, velocity and acceleration until the specified cable feed force was reached. (5) In the cable feeder tool feed synchronization function, the feed motor control parameters mirrored a specified cable feeder tool to one or several other specified cable feeder tools. (6) In the robot movement feed synchronization function, cable feeding was performed in the specified direction, with the velocity mirroring the absolute TCP positioning velocity of a specified robot. (7) In the cable end search function, the cable was fed back into the tool, so that the cable end could be detected when passing the optical fork cable presence sensor. The cable fed distance supervision was then reset and the cable end was positioned at the feeding end of the cable guiding system. (8) In the cog wheels' fitting adjustment function, the angular fitting of the cog wheels was first evaluated. If the fitting was not satisfactory, the deviation from the perfect fit was used to adjust the rotation of the upper feed wheel to the closest fitting position.

3.2.6. Automatic tool calibration procedures

To facilitate tool commissioning and service, we developed and implemented an automatic calibration procedure for the ball screw unit and the lower feed wheel draw wire sensor. Here, the parameters used for translating the draw wire sensor output signal to the feed wheels' distance and for defining the stroke of the ball screw nut were updated. To begin with, default calibration parameters were used to perform a preliminary ball screw nut homing action. Thereafter, the ball screw nut was moved to a number of different positions, including against the lower limit switch and completely closing the cog wheels, while the analogue output signal from the draw wire sensor and the position of the ball screw motor were registered. Finally, these values were used to update the calibration parameters so that they correlated with the exact dimensions and sensor output for the cable feeder tool and a new ball screw nut homing action was performed.

Furthermore, an automatic calibration procedure for the cog wheels' angular fitting supervision was developed and implemented. Here, the parameter used for evaluating the angular fitting of the cog wheels was calibrated. Before the procedure was started, the rotation of the lower cog wheel needed to be fitted manually roughly angularly to the rotation of the upper cog wheel. Next, the cog wheels were closed, so that perfect fitting was achieved. The analogue output signals from the two absolute rotational sensors were then compared and used to update the calibration parameter to correlate with the relative mounting of the cog wheels.

3.2.7. The drum cable feeder tool

Some parts of the above described PLC control system were not needed for the drum cable feeder tool, while other parts needed to be adjusted. To begin with, since the lower feed wheel was controlled by a pneumatic cylinder actuator, only two different stationary feed wheel positions were possible: open and closed. These positions could be supervised with the cylinder Hall Effect sensors. Furthermore, since no draw wire sensor was installed between the main tool housing and the lower feed wheel housing, the compression of the damping power spring mounted between the actuator and the lower feed wheel could not be supervised. Instead, the cable gripping force was assumed to be constant as the cable was gripped and approximated to be about 500 N from manual measuring of the spring compression. Also, there was obviously no need for cable drop supervision or an automatic ball screw calibration procedure. Finally, full control of the drum cable feeder tool needed to be provided to both robot controllers independently. To allow this, the drum feeder tool robot controller sub-procedures were implemented on both robot controllers and the PLC then gave control to the robot controller from which an operation was started.

4. Experimental results

As the final cable feeder tool prototype version was accomplished, the functions of the prototype tools were validated using the experimental setup and methods presented in Section 2. This included robotized cable winding experiments. In the rest of this section, the experimental validations are presented for general tool requirements in Section 4.1, for cable gripping functions in Section 4.2 and for cable feed functions in Section 4.3.

4.1. General requirements

In the experiments, all tools were fully controlled by the PLC. We validated full control through the robot controllers and the tools were validated to be able to handle the specified winding cable and stator section. The tool design was found to be rigid, no significant tool wear beyond expectation was detected and tool maintenance was not required. Table 2 presents the total tool component costs, including the energy chains on the robot arm, the connection cables, the estimated costs for in-house component manufacturing and a shared cost for the common servo motor drive cabinet, but excluding all other costs related to the PLC and other side equipment, together with estimations of the required assembly times and the total tool costs.

Robotized cable winding experiments validated that the robot tools were able to catch the cable, direct it into and feed it through a slot hole in the stator section and were able to push down the end windings with the required accuracy. In Fig. 12a, a robot cable feeder tool is positioned with the receiving end of its cable guiding system against a slot hole in the stator section. The winding cable has been pushed through the slot hole, from the other side of the stator section by the other robot cable feeder tool, and received by the feeder tool which is now pulling the cable through the stator section. Next, in Fig. 12b, the robot cable feeder tool has rotated 180°, performed a cable end search operation

Table 2

Estimations of the component costs, required assembly time and total cost, for the two constructed cable feeder tool prototype versions.

Cable feeder tool version	Component cost [EUR]	Assembly time [h]	Total cost [EUR]
Robot cable feeder tool	18,700	60	20,500 ^a
Drum cable feeder tool	9100	30	10,000 ^a

^a Assuming the assembly is performed in-house by experienced personnel for 30 EUR/h.

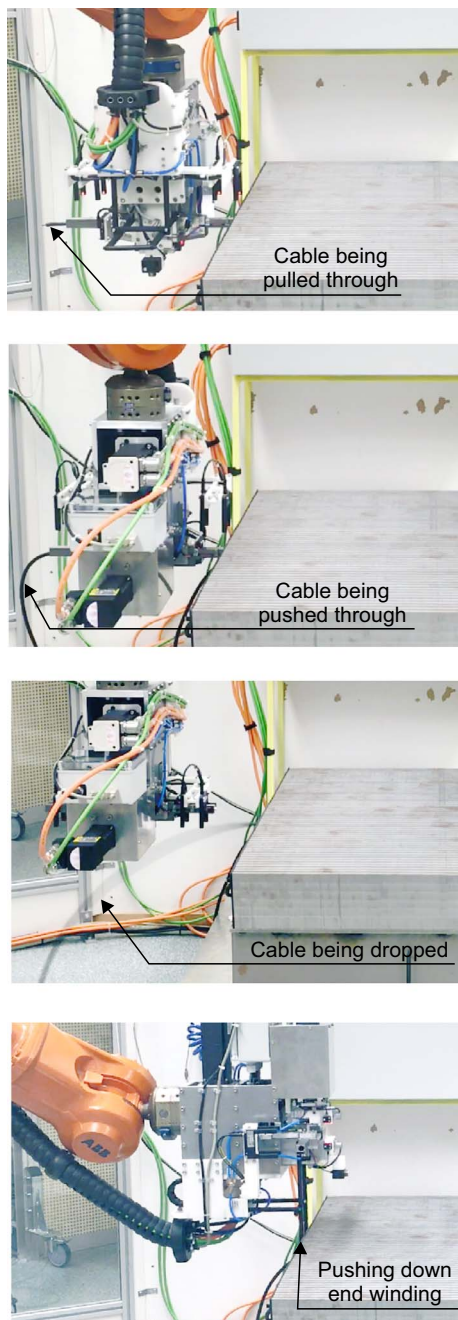

Fig. 12. (a) A robot cable feeder tool pulling cable through the stator section during robotized stator cable winding experiments. (b) A robot cable feeder tool pushing cable through the stator section during robotized stator cable winding experiments. (c) A robot cable feeder tool dropping a cable during robotized stator cable winding experiments. (d) A robot cable feeder tool pushing down the end windings during robotized stator cable winding experiments.

and is now positioned with the feeding end of its cable guiding system against another slot hole in the stator section and pushing the cable through the stator section. In Fig. 12c, the cable has been pushed through the stator section and into the other robot cable feeder tool on the other side of the stator section and the feeder tool is now dropping the cable. Finally, after the cable has been completely pulled through the stator section by the other robot cable feeder tool, the remaining end winding loop between the two slot holes is now pushed down by the feeder tool using its push handle, see Fig. 12d. Positional calibration of the stator section and positioning the cable guiding system end against a stationary surface was performed with sufficiently high

accuracy. The cycle time for performing positional calibration with one robot was about 150 s while using the snap action switch to position the cable guiding system end with higher accuracy against the stator section side took about 2.5 s extra time per positioning. Dropping the cable from the robot tool was performed very reliably. The cable drop supervision was able to supervise that a cable had not been dropped. However, the drop supervision did fail in detecting a cable drop if the cable was not dropped straight down, causing one or several of the drop supervision sensors to be activated more than once.

In corresponding experiments, the drum cable feeder tool was validated to be able to direct and feed cable into the receiving end of the cable guiding system of a robot cable feeder tool.

4.2. Gripping the cable

In the robotized stator cable winding experiments, the robot cable feeder tool was also validated to be able to reliably open and half-open the feed wheels, to grip the cable and to adjust the cable gripping force with the required accuracy. The positioning of the lower feed wheel between pre-defined positions and adjusting a grip was performed very fast, while gripping a cable required a low feed wheel positioning velocity in order to achieve an accurate gripping force supervision and thus high gripping force accuracy. Fig. 13 shows the most relevant process parameters for typical lower feed wheel positioning operations.

The cable gripping and cable gripping force adjustment functions and the gripping force supervision were validated experimentally to be durable and sufficiently accurate. Cable feeding with up to 1000 N gripping force was validated. In Fig. 14, Kernel distributions for the gripping force supervision and the achieved gripping force accuracy measurements are presented together with histograms, while Table 3 presents the corresponding standard mean deviations.

It was experimentally validated that the feed wheels' distance supervision, the cog wheels' fitting supervision, the ball screw nut homing function, the cog wheels' fitting adjustment function and the automatic tool calibration procedures were durable and sufficiently accurate. The cycle time of the ball screw nut homing function was up to 20 s—depending on the ball screw nut position when initiated—while the cycle time for the automatic feed wheels' distance calibration procedure was about 85 s and the cycle time for the automatic cog wheels' fitting calibration procedure was about 10 s.

In corresponding experiments, the drum cable feeder tool was validated to be able to open and close the feed wheels with the required accuracy. The cycle time for re-positioning the lower feed wheel was about 3 s. Furthermore, the cable gripping force was validated to be suitable for feeding cable from the cable drum. Finally, a validation of the durability and required accuracy of the lower feed wheel position

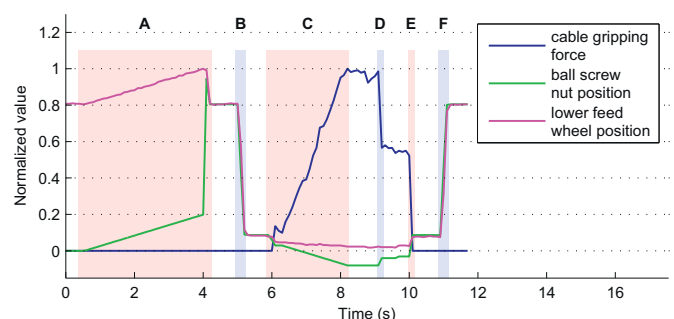

Fig. 13. Normalized values of the supervised cable gripping force, ball screw nut position and lower feed wheel position during typical feed cable gripping operations. Zone A highlights a ball screw nut homing operation, Zone B highlights a feed wheel half-close operation, Zone C highlights a cable gripping operation, Zone D highlights a cable gripping force adjustment operation, Zone E highlights a feed wheel half-open operation and Zone F highlights a feed wheel open operation. The measurement sampling frequency was 10 Hz. For reference, the actual maximum values shown in the figure are 495 N force and 348 mm position.

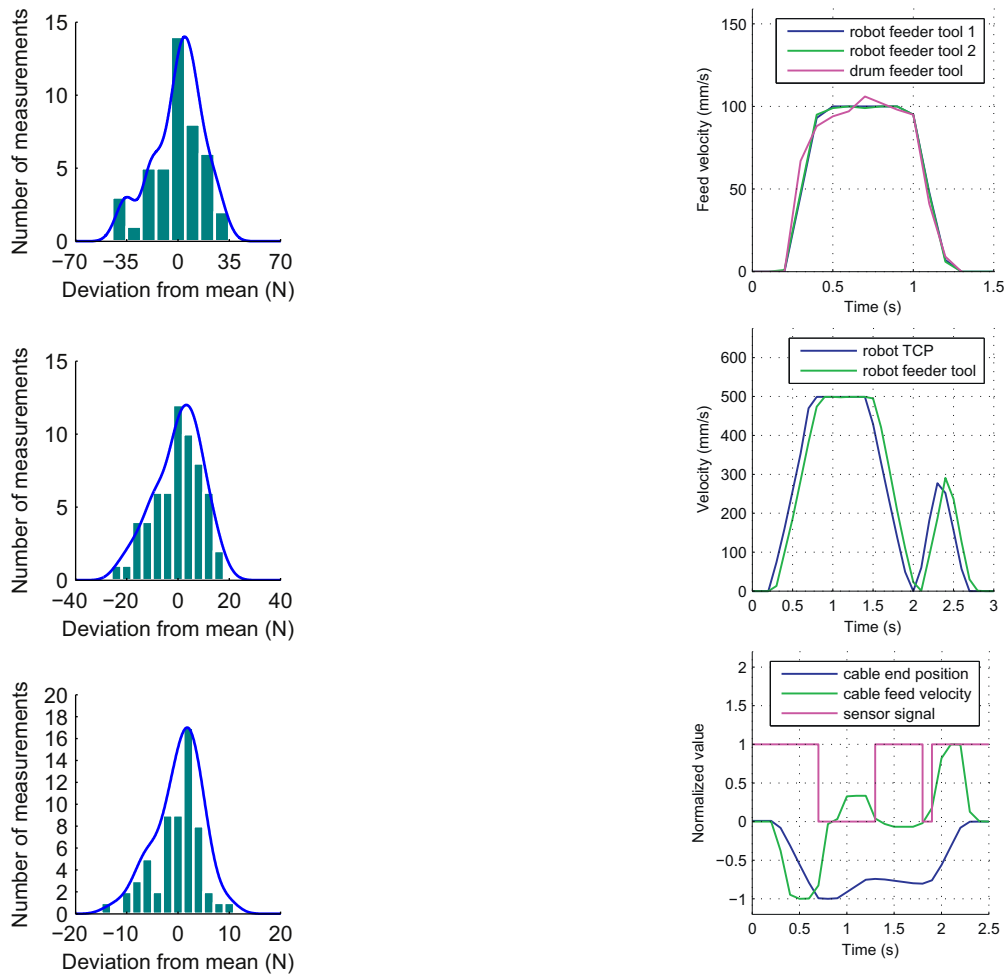

Fig. 14. (a) A histogram and the Kernel distribution for the 44 gripping force supervision accuracy measurements. (b) A histogram and the Kernel distribution for the 60 gripping force accuracy measurements after a cable gripping. (c) A histogram and the Kernel distribution for the 60 gripping force accuracy measurements after an adjusted grip.

Table 3
Calculated standard mean deviations for the experimental accuracy results for cable gripping supervisions and functions.

Experiment	Standard mean deviation
Gripping force supervision	18 N
Achieved gripping force grip	10 N
Achieved gripping force adjusted grip	5 N

supervision was successfully performed.

4.3. Feeding the cable

The robot cable feeder tool was validated in the experiments to be able to feed and pull the cable through the stator section with the required accuracy. All developed feed motor functions were validated to be durable and sufficiently accurate. The cycle time for the cable end search function was about 2 s. In Fig. 15, the most relevant process parameters are shown for a short cable feeder tool feed synchronization operation, for a short robot movement feed synchronization operation, for a cable end search operation, for a feed to force operation and for repeated cog wheels' fitting adjustment operations.

It was experimentally validated that the cable feed force supervision was durable and sufficiently accurate. In the experiments, the cable feeder tool pulled gravity masses of up to 420 N and achieved cable feed

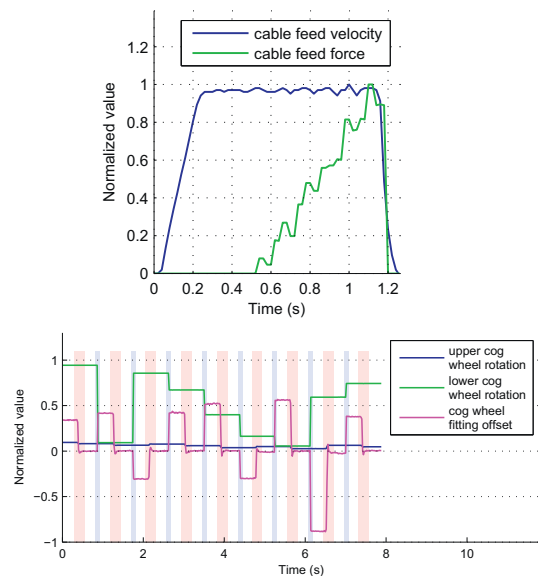

(caption on next page)

velocities up to 1.5 m/s. Fig. 16 presents Kernel distributions for the cable feed force supervision, the cable fed distance supervision and the feed wheel fed distance accuracy measurements together with histograms. The corresponding standard mean deviations are presented in Table 4.

Finally, a validation of the durability and required accuracy of the

Fig. 15. (a) The cable feed wheels' velocities for all three cable feeder tools during a short cable feeder tool feed synchronization operation, with measurement sampling frequency 10 Hz. (b) The robot linear TCP positioning velocity and the cable feeder tool feed wheels' velocity during a short robot movement feed synchronization operation, with measurement sampling frequency 10 Hz. (c) Normalized values of the cable end position relative to the feeding end of the cable guiding system, the cable feed wheels' velocity and the optical fork cable presence sensor signal during a typical cable end search operation, with measurement sampling frequency 10 Hz. For reference, the actual maximum absolute values shown in the figure are 124 mm position and 300 mm/s velocity. (d) Normalized values of the cable feed wheels' velocity and the supervised cable feed force during a feed-to-force operation, with measurement sampling frequency 50 Hz. For reference, the actual maximum values shown in the figure are 103 mm/s velocity and 238 N force. (e) Normalized values of the upper and lower cog wheels' rotations and the supervised cog wheel fitting offset during nine cog wheels' fitting adjustment operations. The rotation of the lower wheel was manually changed between the adjustments. Red zones highlight cog wheel fitting operations and blue zones highlight manual lower wheel rotation changes. The measurement sampling frequency was 50 Hz. For reference, the actual values of the cog wheels' rotation range from 0 to 360°, while 0 cog wheel fitting offset means perfect fitting and 1 cog wheel fitting offset means cog against cog.

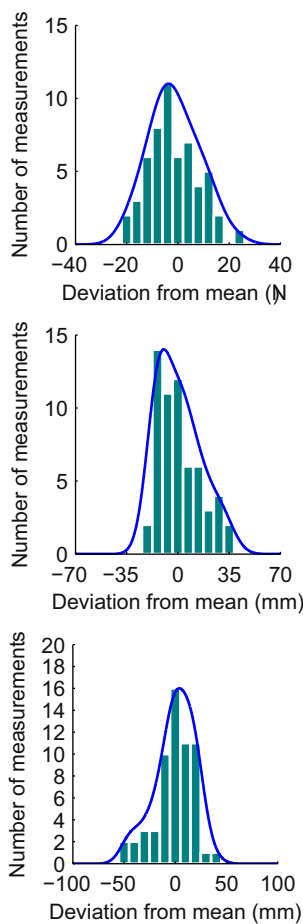

Fig. 16. (a) A histogram and the Kernel distribution for the 55 feed force supervision accuracy measurements. (b) A histogram and the Kernel distribution for the 60 feed distance supervision accuracy measurements. (c) A histogram and the Kernel distribution for the 60 feed wheel distance supervision accuracy measurements.

Table 4

Calculated standard mean deviations for the experimental accuracy results of the cable feed force and cable feed distance supervisions and functions.

Experiment	Standard mean deviation
Feed force supervision	11 N
Fed distance supervision	16 mm/10 m
Feed wheel fed distance	21 mm/10 m

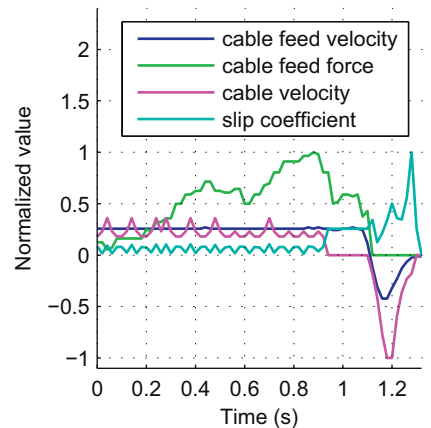
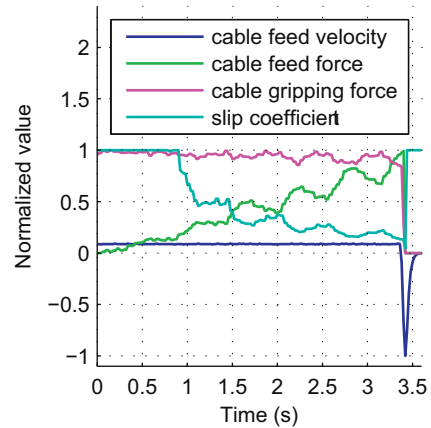

Fig. 17. (a) Normalized values of the cable feed wheels' velocity, the supervised cable feed force, the supervised cable gripping force and the calculated force slip coefficient during a feed-to-slip operation where the slip coefficient limit was adjusted to 1 and the velocity slip supervision was inactivated, with measurement sampling frequency 50 Hz. For reference, the actual maximum absolute values shown in the figure are 228 mm/s velocity and 405 N force. (b) Normalized values of the cable feed wheels' velocity, the supervised cable feed force, the supervised cable velocity and the calculated velocity slip coefficient during a feed-to-slip operation. Here, the slip detection time was adjusted to 0.1 s, a cable gripping force of about 75 N was used and the force slip supervision was inactivated. The measurement sampling frequency was 50 Hz. For reference, the actual maximum absolute values shown in the figure are 84 N force and 78 mm/s velocity.

cable feed slip supervision was successfully performed. In Fig. 17, the most relevant process parameters are shown for two short cable feed-to-slip operations, performed as described in Section 2 and stopped by the two different cable feed slip supervision functions. From Fig. 17b, the static frictional coefficient between the feed surface of a feed wheel and the surface of the cable can be roughly estimated to be 0.56, assuming that the two feed wheels transfer half of the achieved feed force each to the cable.

In corresponding experiments, the drum cable feeder tool was validated to be able to pull cable from a cable drum with the required accuracy. Furthermore, cable feed forces above 110 N were recorded during winding experiments and cable feed velocities up to 1.5 m/s were achieved.

5. Discussion

Designing and evaluating the constructed cable feeder tool prototypes was a very repetitive and extensive process. Most of the tool functions have therefore been optimized to enable robotized stator cable winding and further improvements are likely possible. All tool components were needed and used fully during the winding experiments.

The presented cable feeder tool design was adapted for the third generation UU WEC generator. However, it is likely that the tool design is scalable to some extent. For example, the same conceptual tool design has previously been demonstrated for smaller cables [13]. Larger cables or much higher required feed forces might necessitate redesigning the feed mechanism, but the overall tool concept is likely to be scalable. Hence, adapting the tool for other similar cable winding applications, including but not limited to high-voltage motors, power transformers, wind power generators and hydropower generators [36–39] is likely to be possible. This would enable a broader use of the cable winding technology, especially where large scale production is required, since the current manual assembly is very time consuming and exhausting. By comparing the validated performance of the constructed tools with a previous theoretical analyze of the proposed robotized winding process [34], high potential assembly cycle time and cost savings compared to manual cable winding are indicated. Another important advantage with the presented cable feeder tool concept is the very high flexibility in adapting to and switching between different stator geometries and winding patterns using the same equipment and without compromising on the stator design. Considering the general production trend with smaller batch series and increased customizations [40], an automated stator winding concept providing such flexibility and assembly cost savings even for larger machines is likely to have a high market potential. Furthermore, the developed tool could enable a simplified and possible more durable automated winding assembly with fewer assembly steps compared to conventional winding methods, including eliminating the critical winding insulation assembly step and much reducing the need for end winding connections [34]. It is possible that the presented cable feeder tool concept could be utilized to some extent for other similar applications as well, such as cable laying, cable manufacturing and to grab or feed other components with high precision.

In the presented experimental validation of the tool performance, it was not possible to include all the parameters, such as cable specific variations regarding deformation and wear. For example, feeding a cable which had been deformed from wear, making its cross section oval, did require an additional feed force of up to about 30 N compared to feeding a new circular cable. The presented cable feed force supervision accuracy results apply to cables which had been exposed to moderate wear. Therefore, the presented accuracy results should be regarded as estimations and the successful validation in robotized stator cable winding experiments was necessary. Regarding the standard mean deviations presented in Table 3, it should be noted that the gripping force supervision accuracy must be added to the achieved gripping force accuracy to fully estimate the accuracy of the achieved gripping force.

From the cable fed distance evaluation results in Table 4, it can be noticed that the accuracy of the supervised cable fed distance was only slightly higher than the accuracy of the feed wheels' cable fed distance accuracy. However, while these experiments were performed with a free cable, the feed wheels' fed distance accuracy was much less accurate when higher feed forces were required and influenced significantly by cable wear while the fed distance supervision accuracy was much less influenced by these parameters. The presented fed distance supervision accuracy was high in relation to commercially available cable length measuring machines. When a fatal error PLC control system error was triggered, all cable feeder tools servo motors were immediately shut down. This explains the negative cable and cable feed velocities in ends of the feed-to-slip operations presented in Fig. 17, since the cable was then pulled back by the retracting tension spring.

The double feed wheel cable feed concept was validated for the intended application. The presented estimation of the static frictional coefficient between the feed wheel and the cable indicate that the new feed mechanism design did require a lower cable gripping force in relation to feed force compared to the previous cable feeder tool design. The feed force and the velocity performance of the robot cable feeder

tools was very high in relation to corresponding commercially available electric driven cable feeder tools. It was possible to achieve higher cable feed forces than validated here, but this was not necessary for the intended application. However, the cable feed force supervision experiments that repeated cable feeding with very high feed forces over the same cable part did damage the cable insulation. No such wear was noticed during the robotized cable winding experiments, but if significantly higher feed forces are required in the future, the feed mechanism might need to be replaced e.g. with feed belts that are gentler to the cable.

A full evaluation of the constructed cable feeder tool prototypes, including the ability to prevent cable twisting during the winding procedure and actual winding application cycle times, requires further long-term experiments in full-scale robotized stator cable winding. However, some suggestions on how to further develop the tools can be given based on the present experience. To begin with, the reliability of the cable drop supervision could be improved, e.g. by adding another vertical layer of drop supervision sensors to supervise that the cable passes in the desired direction. This would also eliminate the theoretical risk that the cable drop supervision is passed without the cable being completely dropped, because the cable moved back and forth in front of one or several drop supervision sensors without passing downwards. Furthermore, gripping a cable with the robot cable feeder tool was time consuming, considering the frequency of performing this operation in the intended application. As can be understood from Fig. 13, the gripping function could be sped up using a higher ball screw nut linear positioning velocity while compressing the damping power springs, if a lower gripping force accuracy is accepted. Alternatively, it is likely that the gripping operation could be sped up by first gripping the cable with an approximate gripping force using a pre-defined ball screw nut position and then using the gripping force adjustment function to grip the cable with the desired force. The cable end search function was also time consuming, considering the frequency of performing this operation in the intended application. However, with the current control system design, it is not possible to speed up this function without reducing its accuracy more than acceptable. Finally, the supervised values of the cable feed force and the cable velocity did fluctuate significantly, see Figs. 15d and 17b. Even though the accuracy of these supervision functions was sufficient for the intended application, further development and improvement could enhance the tool performance.

6. Conclusions

This article presents an updated cable feeder tool design for robotized stator cable winding. Three cable feeder tool prototypes were constructed and validated successfully for the robotized stator cable winding of the UU WEC generator. We achieved a reliable and compact tool design with high performance, detailed process supervision, integrated automatic tool calibration procedures and high controllability, fully integrated into ABB industrial robot controllers. Hence, the tools are prepared for facilitated implementation, commissioning and service in robotized cable winding applications. It is likely that the same tool concept can be used for other cables and winding applications, thus contributing with high winding assembly flexibility for medium and large sized machines. A full evaluation of the tool design requires further long-term experiments in a full-scale winding application. However, the presented results are very promising and do represent another important step towards an industrial solution for robotized stator cable winding.

Acknowledgments

The authors thank Vargöns Smältverk for their contribution to the funding of this study.

References

- [1] Leijon M, Dahlgren M, Walfridsson L, Li Ming, Jaksts A. A recent development in the electrical insulation systems of generators and transformers. *IEEE Electr Insul Mag* 2001;17(3):10–5.
- [2] Metwally IA, Radwan RM, Abou-Elyazied AM. Powerformers: A breakthrough of high-voltage power generators. *IEEE Potentials* 2008;27(3):37–44.
- [3] Kirkhoff J. Processes and design considerations for automatic assembly of electric motor stators. Proceedings of the electrical insulation conference and electrical manufacturing and coil winding technology conference. 2013. p. 79–88.
- [4] Morreale P. Electric motor and generator manufacturing myths. Proceedings of the electrical insulation conference and electrical manufacturing expo. 2007. p. 413–7.
- [5] Stenzel P, Dollinger P, Richnow J, Franke J. Innovative needle winding method using curved wire guide in order to significantly increase the copper fill factor. Proceedings of the international conference on electrical machines and systems. 2014.
- [6] Franke J, Dobroschke A. Robot-based winding-process for flexible coil production. Proceedings of the electrical manufacturing technical conference. 2009. p. 157–63.
- [7] Akita H, Nakahara Y, Miyake N, Oikawa T. New core structure and manufacturing method for high efficiency of permanent magnet motors. Proceedings of the industry applications conference. 2003. p. 367–72.
- [8] Albrecht T, König W, Bickel B. Proceeding for wiring integrated winding of segmented stators of electric machines. Proceedings of the international electric drives production conference. 2011. p. 132–8.
- [9] Brettschneider J, Spitzner R, Boehm R. Flexible mass production concept for segmented BLDC stators. Proceedings of the international electric drives conference. 2013.
- [10] Kuehl A, Furlan S, Gutmann J, Meyer M, Franke J. Technologies and processes for the flexible robotic assembly of electric motor stators. Proceedings of the IEEE international electric machines and drives conference. 2017.
- [11] Parwal A, Remouit F, Hong Y, Francisco F. Wave energy research at Uppsala University and the Lysekil Research Site, Sweden: A status update. Proceedings of the 11th European wave and tidal energy conference. 2015. p. 6–11.
- [12] Rahm M, Svensson O, Boström C, Waters R, Leijon M. Experimental results from the operation of aggregated wave energy converters. *IET Renew Power Gener* 2012;6(3):149–60.
- [13] Hultman E, Leijon M. A cable feeder tool for robotized cable winding. *Robot Comput-Integr Manuf* 2014;30(6):577–88.
- [14] Alfredson S, Hernäs B, Bergström H. Assembly of generators with rated voltage higher than 100 kV. Proceedings of the 2000 international conference on power systems technology. 1. 2000. p. 189–93.
- [15] Griffioen W, Plutetz G, Nobach HG. Theory, software, testing and practice of cable in duct installation. Proceedings of the international wire & cable symposium. 2006. p. 357–65.
- [16] Mayhew AJ, Stockton DJ. Cost-reduced cable delivery for the 21st century. *BT Technol J* 1998;16(4):92–100.
- [17] Griffioen W, Gutberlet C, Mulder J. New approach to installation of offshore wind energy cables. Proceedings of the international conference on insulated power cables. 2015.
- [18] Griffioen W, Gapany L, Grobety S. Floating cable into duct: recent developments. Proceedings of the international wire & cable symposium. 2013. p. 11–20.
- [19] Griffioen W, Gutberlet C, Plumetz G. New technique to install power cables into ducts. *J Energy Power Eng* 2012;6:1263–75.
- [20] Skinner ML. Trends, advances and innovations in filament winding. *Reinf Plast* 2006;50(2):28–33.
- [21] Markov L, Cheng RMH. Conceptual design of robotic filament winding complexes. *Mechatronics* 1996;6(8):881–96.
- [22] Cazzaniga R, Valle N, D'Urzo C. Winding machines for the manufacturing of superconductive coils of the main European fusion research machines. *Fus Eng Des* 2005;75–79:7–10.
- [23] Zheng YF, Pei R, Chen C. Strategies for automatic assembly of deformable objects. Proceedings of the IEEE international conference on robotics and automation. 1991.
- [24] Jiang X, Koo K, Kikuchi K, Konno A, Uchiyama M. Robotized assembly of wire harness in car production line. Proceedings of the IEEE/RSJ international conference on intelligent robots and systems. 2010. p. 490–5.
- [25] Tamada T, Yamakawa Y, Senoo T, Ishikawa M. High-speed manipulation of cable connector using a high-speed robot hand. Proceedings of the IEEE international conference on robotics and biomimetics. 2013.
- [26] Jiang X, Nagaoka Y, Ishii K, Abiko S, Tsujita T, Uchiyama M. Robotized recognition of a wire harness utilizing tracing operation. *Robot Comput-Integr Manuf* 2015;34:52–61.
- [27] Papacharalampopoulos A, Makris S, Bitzian A, Chryssolouris G. Prediction of cabling shape during robotic manipulation. *Int J Adv Manuf Technol* 2016;82:123–32.
- [28] Hermansson T, Bohlin R, Carlson JS, Söderberg R. Automatic routing of flexible 1D components with functional and manufacturing constraints. *Comput-Aided Des* 2016;79:27–35.
- [29] Yabuta T, Yoshizawa N, Kojima N. Cable kink analysis: Cable loop stability under tension. *J Appl Mech* 1982;49(3):584–8.
- [30] Coyne J. Analysis of the formation and elimination of loops in twisted cable. *IEEE J Ocean Eng* 1990;15(2):72–83.
- [31] Stump DM. The hockling of cables: a problem in shearable and extensible rods. *Int J Solids Struct* 2000;37(3):515–33.
- [32] Ermolaeva NS, Regelink J, Krutzen MPM. Hockling behaviour of single- and multi-rope systems. *Eng Fail Anal* 2008;15(1–2):142–53.
- [33] Hultman E, Leijon M. Automated cable preparation for robotized stator cable winding. *Machines* 2017;5(2):14.
- [34] Hultman E, Leijon M. Utilizing cable winding and industrial robots to facilitate the manufacturing of electric machines. *Robot Comput-Integr Manuf* 2013;29:246–56.
- [35] Hultman E, Leijon M. Six-degrees-of-freedom (6-DOF) work object positional calibration using a robot-held proximity sensor. *Machines* 2013;1:63–80.
- [36] Nestli TF, Stendius L, Johansson MJ, Abrahamsson A, Kjaer PC. Powering Troll with new technology. *ABB Rev* 2003;2:15–9.
- [37] Metwally IA. Failures, monitoring and new trends of power transformers. *IEEE Potentials* 2011;30(3):36–43.
- [38] Dahlgren M, Frank H, Leijon M, Owman F, Walfridsson L. Windformer – Wind power goes large-scale. *ABB Rev* 2000;3:31–7.
- [39] Grabbe M, Yuen K, Apelfröjd S, Leijon M. Efficiency of a directly driven generator for hydrokinetic energy conversion. *Adv Mech Eng* 2013;5:978140http://dx.doi.org/10.1155/2013/978140. 8 pages.
- [40] ElMaraghy H, ElMaraghy W. Smart adaptable assembly systems. *Proc CIRP* 2016;44:4–13.



Erik Hultman received his M.Sc. degree in Energy Systems Engineering in 2010 from Uppsala University, Uppsala, Sweden. He is now Junior Lecturer at the Division of Electricity, Uppsala University, Uppsala, Sweden since 2012 and Chief Production Development Engineer at Seabased Industry AB, Lysekil, Sweden since 2016. He is working towards the Ph.D. degree at the Division of Electricity, Uppsala University, Uppsala, Sweden.



Mats Leijon received the Ph.D. degree in electrical engineering from Chalmers University, Gothenburg, Sweden, in 1987. From 1993 to 2000, he was the Head of the Department for High Voltage Electromagnetic Systems, ABB Corporate Research, Västerås, Sweden. In 2000, he became a Professor of Electricity with Uppsala University, Uppsala, Sweden. Currently, he supervises six Ph.D. students in wave power, marine current power, wind power, hydropower, and within the field of turbo generators. He is also Professor in Electrical Engineering at Chalmers University of Technology, Gothenburg, Sweden. Prof. Leijon is a Member of the Institution of Electrical Engineers (IEE), World Energy Council (WEC), the International Council on Large Electric Systems (CIGRE), and the Swedish Royal Academy of Engineering Science. He was the recipient of the Chalmers Award John Ericsson Medal in 1984, the Porjus International Hydro Power Prize in 1998, the Royal University of Technology Grand Prize in 1999, the 2000 Chalmers Gustav Dahlén Medal, the Grand Energy Prize in Sweden, the Polhem Prize, and the Thuréus Prize.